

TECHNICAL SHEETS FOR COORDINATION

VERTICAL RECOMMENDATION FOR USE SHEETS (RfUs) – Status on August 2017

Number CNB/M/ (1)	Revision (Rev)	Key words	Approved by Vertical Group of NBs ⁽²⁾ on:	Approved by Horizontal Committee of NBs ⁽²⁾ on:	Endorsed by Machinery Working Group on:
Vertical Group 01 – Woodworking machinery					
01.029	05	Tractor driven machine, P.T.O.	24/04/2009	09/12/1998	03/03/2000
01.043	05	Hand fed tenoning machine; working return stroke	24/04/2009	04/12/2001	04/01/2005
01.073	03	Surface planing and thickening machines, position of controls	24/04/2009	10/06/2007	03/03/2008
01.081	02	Single spindle vertical moulding machines, table insert rings	23/04/2010	15/06/2010	30/12/2010
01.082	02	Small woodworking machines with electric brake	23/04/2010	15/06/2010	30/12/2010
01.083	02	Safeguarding of the pressure beam: trip bar – design and dimensions	23/04/2010	15/06/2010	30/12/2010
01.084	02	Material with similar physical characteristics to wood	04/11/2010	14/12/2010	04/07/2012
01.087	05	Chain saws for tree service/top handle machine, electric powered	21/05/2014	18/06/2014	08/01/2015
01.089	03	Electric and electronic brakes, run-down time, failure of power supply	21/05/2014	18/06/2014	08/01/2015
Vertical Group 02 – Meatworking machinery					
02.001	02	Adjustable guards	17/11/2011	13/12/2011	23/04/2012
Vertical Group 03 – Presses for cold-working metals					
03.002	15	Presses – Metal – Field of application	30/09/2009	12/12/1995	04/06/1996
03.004	06	Technical file	30/09/2009	12/12/1995	04/06/1996
03.005	03	Platform, ladders	30/09/2009	17/04/1996	08/06/1998
03.013	08	Acceptability of components of type examined presses	13/10/2010	14/12/2010	23/05/2010
03.022	06	Intrinsic safe pneumatic valve	30/09/2009	18/09/1997	08/06/1998
03.027	06	Secondary protection / Two Hands Control Device / Active Optoelectronic Protective Devices	30/09/2009	19/09/1996	08/06/1998
03.028	06	Failing of springs in the brake	30/09/2009	18/09/1997	08/06/1998
03.029	04	Reaching over, under and around the detection zone	30/09/2009	13/12/1995	04/06/1996
03.032	04	Fixing the tools, failure of one component	30/09/2009	13/12/1995	08/06/1998
03.033	06	Protection measures, die cushion, blank holder and workpiece ejector control system	30/09/2009	12/12/1995	08/06/1998
03.035	04	crushing hazards, ram frame	30/09/2009	12/12/1995	04/06/1996
03.038	07	Fault exclusion/directional valve	30/09/2009	18/09/1997	08/06/1998
03.068	07	Emergency stop	30/09/2009	09/06/2005	29/10/2005
03.073	05	Testing procedure for brake	30/09/2009	19/09/1996	08/06/1998
03.078	08	Protection, flexible piping	30/09/2009	21/11/2005	20/04/2006
03.088	09	C – frame- press, safeguarding at	30/09/2009	07/12/2000	04/01/2005

Number CNB/M/ (1)	Revision (Rev)	Key words	Approved by Vertical Group of NBs⁽²⁾ on:	Approved by Horizontal Committee of NBs⁽²⁾ on:	Endorsed by Machinery Working Group on:
		the sides, single cycle			
03.095	05	Guards, safety distance	29/09/2009	19/09/1996	08/06/1998
03.102	06	Overrun detection / Screw presses	29/09/2009	09/06/2005	29/10/2005
03.111	06	Stopping time measurement / die cushion / ejector	29/09/2009	11/12/2003	01/07/2004
03.117	07	AOPD / Additional guards	29/09/2009	26/11/2009	26/05/2010
03.124	07	Press-brakes / tandem assembly	29/09/2009	21/11/2005	20/04/2006
03.128	08	Overlapping, Monitoring Valves	29/09/2009	09/06/2005	29/10/2005
03.141	04	Bypassing monitored restraint valves	29/09/2009	02/06/1999	03/03/2000
03.143	09	Spindle / Screw presses – block / shoe brakes	12/10/2010	14/12/2010	23/05/2011
03.154	07	Hydraulic presses, Mechanical restraint device, Production and Maintenance	30/09/2009	24/10/2002	02/03/2004
03.157	05	Press-Brake, Hydraulic Press, Release of trapped persons	29/09/2009	09/06/2005	29/10/2005
03.159	06	Valve monitoring, PES	29/09/2009	24/10/2002	02/03/2004
03.160	05	Automatic cycle - AOPD / Interlocking guard without guard locking valve monitoring	29/09/2009	04/12/2001	04/01/2005
03.162	09	AOPD - Press Brakes	20/03/2007		21/04/2015
03.164	06	Press Brakes – Mode selection	29/09/2009	16/06/2003	17/12/2003
03.165	05	Press Brakes, Light curtains-Blanking	29/09/2009	16/06/2003	17/12/2003
03.166	06	Press Brakes, AOPD	29/09/2009	16/06/2003	17/12/2003
03.170	05	Hydraulic Presses with “Low force approach” – Controls	29/09/2009	16/06/2003	17/12/2003
03.172	04	Safety valve, separated clutch and brake	29/09/2009	16/06/2003	17/12/2003
03.176	05	Restart / Reset / AOPD	29/09/2009	09/06/2005	29/10/2005
03.177	04	Hydraulic press brake – AOPD moving with the beam, box bending, mode confirmation	29/09/2009	09/12/2004	24/05/2005
03.179	04	Press-brakes – Working with one side guard open	29/09/2009	09/12/2004	24/05/2005
03.180	04	Press-brakes – Ancillary devices – Powered tools clamping devices	28/09/2009	09/12/2004	24/05/2005
03.182	04	Press-brakes – ESPE using AOPD in the form of laser beams – Additional crushing hazard	28/09/2009	09/12/2004	24/05/2005
03.185	05	Movable screens	30/09/2009	09/06/2005	29/10/2005
03.186	06	Acceptability of a component, configurable or parameterizable PES	28/09/2009	26/11/2009	26/05/2010
03.187	05	Failure of auxiliary powered functions for setting	30/09/2009	09/06/2005	29/10/2005
03.188	06	Front guard switch	28/09/2009	10/08/2008	08/01/2009
03.189	05	Defeat of protective measures on presses	30/09/2009	21/11/2005	20/04/2006
03.192	04	Press brakes – secondary working devices	06/10/2008	09/12/2008	18/06/2009
03.194	05	Servo press (Power Presses & Press Brakes), brake	03/03/2009	10/06/2009	25/12/2009
03.196	04	Servo presses, protective measures	07/10/2008	09/12/2008	08/06/2009

Number CNB/M/₍₁₎	Revision (Rev)	Key words	Approved by Vertical Group of NBs⁽²⁾ on:	Approved by Horizontal Committee of NBs⁽²⁾ on:	Endorsed by Machinery Working Group on:
03.200	05	Servo-presses (Power Presses & Press Brakes), Stopping performance monitoring	03/03/2009	10/06/2009	25/12/2009
03.201	05	Servo-presses (Power Presses & Press Brakes), STO, prevention of unintended start	04/03/2009	10/06/2009	25/12/2009
03.202	04	Press brakes – back gauge movement initiation	03/03/2009	10/06/2009	25/12/2009
03.204	03	Presses – Safety distances	28/09/2011	11/12/2012	04/06/2013
03.206	03	Presses – Two hand control device (THCD)	27/09/2012	11/12/2012	04/06/2013
03.207	03	Press-brakes – Powered work-piece supports	27/09/2012	11/12/2012	04/06/2013
03.210	04	Servo press-brake connection between motor and screw	24/09/2015	02/12/2015	23/09/2016
03.211	02	Press-brakes – Powered work-piece supports	26/09/2014	24/06/2015	23/09/2016
Vertical Group 04 – Injection or compression moulding machines					
04.004	04	Moulding machine. Essential equipments and accessories	25/08/2009	11/03/1997	08/06/1998
04.005	04	Moulding machines. Materials used during the construction of these machines	25/08/2009	11/03/1997	08/06/1998
04.009	08	Moulding machinery / Automatic loading and unloading	25/08/2009	10/04/2007	14/09/2007
04.011	04	Moulding machinery / injection for plastics / light curtains /movable guards / mould protection	25/08/2009	18/09/1997	08/06/1998
04.013	05	Injection moulding machine with fence; mechanical latch	25/08/2009	02/12/1999	09/04/2001
04.014	04	Machine with fence and robot crossing the mould area into the fence area behind the machine	25/08/2009	21/11/2005	20/04/2006
04.017	05	Stepping behind the rear guard of the mould area, Horizontal injection moulding machine	25/08/2009	02/12/1999	09/04/2001
04.018	04	Restart the mould closing movement by closing guard gate	25/08/2009	18/09/1997	08/06/1998
04.029	04	Vertical Injection or Compression Moulding Machine Response-time of the hydraulic system	25/08/2009	02/06/1999	03/03/2000
04.034	05	Rubber and Plastics injection moulding machine; interlocking of movable guards providing access to the closing mechanism area	25/08/2009	02/12/1999	04/01/2001
04.035	04	Rubber and Plastics Injection Moulding Machines. Equipment grounding conductors provided on limit switches	26/08/2009	02/06/1999	03/03/2000
04.038	05	Injection moulding machines for rubber; laser scanners	26/08/2009	07/12/2000	04/01/2005
04.039	05	Rubber and Plastics injection moulding machines / Accessible mould area / Pressure-sensitive	26/08/2009	07/12/2000	04/01/2005

Number CNB/M/ (1)	Revision (Rev)	Key words	Approved by Vertical Group of NBs⁽²⁾ on:	Approved by Horizontal Committee of NBs⁽²⁾ on:	Endorsed by Machinery Working Group on:
		platforms in the mould area			
04.040	05	Injection moulding machines; automatic sequence control, guard closing; latch retracting, mould closing. Machines tie bar distance>1200 mm	26/08/2009	02/12/1999	09/04/2001
04.041	08	Injection moulding machines; automatic sequence control, guard closing; latch retracting, mould closing. Machines tie bar distance>1200 mm	26/08/2009		09/04/2001
04.043	04	Horizontal moulding machines / Safety distances / Shape of the guard	26/08/2009	07/12/2000	04/01/2005
04.044	04	Rubber and Plastics injection moulding machines / Risk analysis in the technical file	26/08/2009	07/12/2000	04/01/2005
04.051	04	Rubber and Plastics injection moulding machines / Monitoring by a programmable controller	26/08/2009	07/12/2000	04/01/2005
04.052	04	Rubber and Plastics injection moulding machines / Interlocking of movable guards that give access to the mould area	26/08/2009	07/12/2000	04/01/2005
04.053	04	24 VDC hydraulic valves, protective bonding circuit connection on the voltage supply plug of a 24 VDC solenoid valve	26/08/2009	19/06/2001	04/01/2005
04.064	05	Injection moulding machine for plastics – Emergency stop, heating elements	26/08/2009	09/12/2004	24/05/2005
04.067	04	Injection moulding machines for plastics, horizontal closing machines Interlocking of rotational mould movements inside the mould area	26/08/2009	09/12/2004	24/05/2005
04.069	06	Injection moulding machines – Protection device type III	26/08/2009	10/06/2008	08/01/2009
04.073	05	Plastics and rubber machines – compression moulding machines – mechanical restraint device	26/08/2009	10/06/2008	08/01/2009
04.075	04	Plastics and rubber machines – compression moulding machines – detection of persons standing behind a light curtain within the tool area	26/08/2009	10/06/2008	08/01/2009
04.076	03	Plastics and rubber hydraulic IMM – horizontal mould closing movement – motor control unit	26/08/2009	09/12/2008	18/06/2009
04.077	03	Plastics and rubber horizontal IMM – two platens machine – high pressure mould closing movement	26/08/2009	09/12/2008	08/06/2009
04.078	03	Plastic and rubber IMM – plasticizing unit– measurement of the temperature on the surface of the cover of the plasticizing unit	26/08/2009	09/12/2008	08/06/2009
04.083	04	Injection machines with tie bar	13/09/2011	13/12/2011	23/04/2012

Number CNB/M/ (1)	Revision (Rev)	Key words	Approved by Vertical Group of NBs ⁽²⁾ on:	Approved by Horizontal Committee of NBs ⁽²⁾ on:	Endorsed by Machinery Working Group on:
		distances >1200 mm; person standing behind the mould at the rear side of the machine or entering the mould area from the operator's side			
04.086	04	Electrical axis; guards locking, detection standstill	19/05/2015	24/06/2016	23/09/2016
Vertical Group 05 – Machines for underground work					
05.001	05	Internal combustion engine, emission of dust, gas, exhaust	03/11/2009	07/12/2000	04/01/2005
05.002	05	Internal combustion engine, emission of dust, gas, exhaust, methane in intake air	03/11/2009	07/12/2000	04/01/2005
05.007	04	Internal combustion engine, emission of dust, gas, exhaust, limits	03/11/2009	07/12/2000	04/01/2005
05.201	03	Hydraulic powered roof support	03/11/2009	13/12/1995	04/06/1996
05.202	02	Hydraulic powered roof support, components with safety function, safety components	03/11/2009	13/12/1995	04/06/1996
05.208	03	Hydraulic powered roof support, placing on the market, putting into service	03/11/2009	12/12/1995	04/06/1996
05.220	05	Hydraulic powered roof support, support unit, technical file, EC-type examination	03/11/2009	07/12/2000	04/01/2005
05.221	04	Hydraulic powered roof support, single props	03/11/2009	07/12/2000	04/01/2005
05.222	04	Hydraulic powered roof support, pressure supply, EC-type examination	03/11/2009	07/12/2000	04/01/2005
05.601	05	Locomotive, EC-type examination, running test	03/11/2009	07/12/2000	04/01/2005
05.603	05	Locomotive, EC type examination certificate, putting into operation, control	03/11/2009	07/12/2000	04/01/2005
05.604	05	Locomotive, definition	03/11/2009	07/12/2000	04/01/2005
05.801	02	Machines for tunnels	03/11/2009	12/12/1995	25/03/1997
Vertical Group 06 – Household waste collection skips (RCVs)					
06.005	05	Calculations	15/04/2010	11/03/1997	08/06/1998
06.012	06	Automatic lifting device- operation mode	15/04/2010	10/06/2008	08/01/2009
06.014	06	Exhaust pipe	15/04/2010	11/06/1998	04/01/2005
06.016	05	Energy separation main switch	15/04/2010	11/03/1997	08/06/1998
06.023	08	Refuse Collection Vehicles (RCV) – Hose burst protection valves	15/04/2015	24/06/2015	23/09/2016
06.025	03	Electrical equipment	15/04/2010	10/06/2008	08/01/2009
06.026	07	Automatic gear box	15/04/2010	10/06/2008	08/01/2009
06.027	07	RCV – fixing points of the bodywork on the chassis	15/04/2010	15/06/2010	30/12/2010
06.029	04	Footboards EHSRs 3.2.3	15/04/2010	09/12/1998	03/03/2000
06.034	10	Refuse collection vehicle (RCV) - rear footboard	15/04/2015	24/06/2015	23/09/2016
06.035	05	Lifting device	16/04/2010	04/12/2001	04/01/2005
06.036	07	RCV-Remote control in the cab	24/04/2013	26/06/2013	22/11/2013

Number CNB/M/ (1)	Revision (Rev)	Key words	Approved by Vertical Group of NBs⁽²⁾ on:	Approved by Horizontal Committee of NBs⁽²⁾ on:	Endorsed by Machinery Working Group on:
06.039	03	Rave rail / open operation system	16/04/2010	24/10/2002	02/03/2004
06.040	03	Riding of operatives	16/04/2010	11/12/2003	01/07/2004
06.042	06	Performance level	16/04/2010	26/11/2009	26/05/2010
06.043	03	Element intended to be incorporated / carrying chassis / EC type-examination / EC declaration of conformity	20/05/2008	09/12/2008	04/07/2012
06.045	03	Refuse Collection Vehicles (RCV) - Compaction start	09/04/2014	18/06/2014	23/09/2016
Vertical Group 08 – Vehicle servicing lifts					
08.001	04	Polyamide Nuts	12/04/2010	13/12/1995	04/06/1996
08.002	04	EC type test	12/04/2010	09/12/1998	03/03/2000
08.003	05	Instruction handbook, check	12/04/2010	09/12/1998	03/03/2000
08.004	05	Measures against unintentional desynchronisation during operation	12/04/2010	17/04/1996	08/06/1998
08.007	03	Horizontal forces, loading system for motor bikes lifts	12/04/2010	17/04/1996	08/06/1998
08.008	03	Auxiliary lifting systems	12/04/2010	17/04/1996	08/06/1998
08.011	03	Short stroke lifts –Definition	12/04/2010	17/04/1996	08/06/1998
08.015	03	Rails foot protectors, protection against pinching points	12/04/2010	11/12/2003	01/07/2004
08.016	03	Chassis supporting vehicle lift for road vehicles, load distribution	12/04/2010	11/12/2003	01/07/2004
08.018	05	Load distribution on two post lifts with load-bearing arms	25/04/2013	26/06/2013	22/11/2013
Vertical Group 09 – Lifting Persons Devices					
09.206	04	Lifting Persons Device (LPD), Suspended Access Equipment, modular construction, certification	13/04/2010	11/12/2003	14/03/2007
09.207	10	Type-examination	13/04/2010	26/11/2009	26/05/2010
09.209	04	EC type-examination, work platform, loader crane	13/04/2010	11/12/2003	01/07/2004
09.305	06	Mobile Elevated Workplatform (MWEF), levelling system	13/04/2010	11/06/1998	09/04/2001
09.306	05	Mobile Elevated Workplatform (MWEF), levelling system	13/04/2010	11/06/1998	09/04/2001
09.307	04	Lifting Persons Device, safety gear	13/04/2010	24/05/2000	09/04/2001
09.309	04	Mobile Elevated Work Platform, MEWP, access, movable guard, abnormal use	13/04/2010	24/05/2000	09/04/2001
09.310	05	Man rider winches, one rope suspension	13/04/2010	24/05/2000	09/04/2001
09.401	08	MEWP, control devices, emergency stop, override	13/04/2010	11/12/2003	01/07/2004
09.501	05	Radiation, EC type- examination, EMC directive	13/04/2010	24/05/2000	09/04/2001
Vertical Group 11 – Safety components					
11.017	05	EC type-examination, pre-standards	25/10/2010	11/06/1998	09/04/2001
11.027	08	Two-hand control devices, synchronous actuation	25/10/2010	14/12/2010	23/05/2011
11.031	09	ESPE Type 2 with PLC as means	25/10/2010	14/12/2010	23/05/2011

Number CNB/M/ (1)	Revision (Rev)	Key words	Approved by Vertical Group of NBs ⁽²⁾ on:	Approved by Horizontal Committee of NBs ⁽²⁾ on:	Endorsed by Machinery Working Group on:
		of periodic test			
11.032	05	Arrangement of visual indicators	25/10/2010	03/03/2004	24/12/2004
11.033	06	THCD, termination of one or both input signal(s) in case of a fault occurring	25/10/2010	09/12/2004	24/05/2005
11.035	08	Indication of a muted ESPE, colour of the mute indicator(s) of an ESPE	25/10/2010	14/12/2010	23/05/2011
11.036	07	Laser scanner, industrial truck	25/10/2010	14/12/2010	23/05/2011
11.042	04	THCD, non-mechanical actuating devices	25/10/2010	21/11/2005	20/04/2006
11.045	13	Logic units to ensure safety functions	17/10/2011	24/06/2015	23/09/2016
11.047	03	Using parts with wear-out in safety components	11/05/2010	15/06/2010	30/12/2010
11.049	03	Logic units to ensure safety functions / Environmental conditions	25/10/2010	14/12/2010	23/05/2011
11.050	05	Failure, electromechanical outputs	06/06/2013	26/06/2013	22/11/2013
11.052	02	Safety components, safety functions	18/10/2011	13/12/2011	23/04/2012
11.053	03	Manual reset function	10/05/2012	28/06/2012	17/01/2013
11.054	03	Safety components, instructions	06/06/2013	26/06/2013	22/11/2013
11.055	04	Cogeneration plants, combined heat and power plants (CHP), grid monitoring	02/06/2014	17/06/2014	08/01/2015
11.056	03	Two-hand control devices, synchronous actuation, operating conditions	07/06/2013	26/06/2013	22/11/2013
11.058	03	Safety component, warning device	07/06/2013	26/06/2013	22/11/2013
11.059	03	Diagnostic functions, EN 61508:2010	03/06/2014	17/06/2014	08/01/2015
11.060	03	External DC power supply of safety component, PELV, abnormal voltage	03/06/2014	18/06/2014	08/01/2015
11.062	04	Pressure-sensitive protective device, sensor, control unit, OSSDs, definition	09/06/2015	02/12/2015	23/09/2016
Vertical Group 12 – ROPS and FOPS					
12.007	05	DLV	21/11/2013	10/12/2013	15/04/2014
12.009	05	Minor modification	21/11/2013	10/12/2013	15/04/2014
12.010	05	FOPS, Standing operator	21/11/2013	10/12/2013	15/04/2014
12.012	07	ROPS	21/11/2013	10/12/2013	15/04/2014
12.016	02	FOPS, tiltable cab	21/11/2013	10/12/2013	15/04/2014
Vertical Group 13 – Full quality assurance					
13.000	03	Equivalence to Annex IX	21/08/2008	09/12/2008	18/06/2009
13.001	04	Final inspection, quality management, intermediate inspections	17/09/2007	10/06/2008	08/01/2009
13.002	07	quality system, compliance with standards, accreditation	26/08/2010	14/12/2010	23/05/2011
13.003	04	Application, quotation, selection of Notified Body	17/09/2007	10/06/2008	08/01/2009

Number CNB/M/ (1)	Revision (Rev)	Key words	Approved by Vertical Group of NBs⁽²⁾ on:	Approved by Horizontal Committee of NBs⁽²⁾ on:	Endorsed by Machinery Working Group on:
13.004	04	Manufacturer, sub-contractors, conformity, supplier, subsidiaries	17/09/2007	10/06/2008	08/01/2009
13.005	04	Representative model, categories of machinery, risks	17/09/2007	10/06/2008	08/01/2009
13.006	02	EC declaration of conformity, technical file	17/09/2007	04/12/2007	04/06/2008
13.007	03	Technical file, assessment on site, quality system	17/09/2007	04/12/2007	04/06/2008
13.008	02	Complete technical file, documentation, complex machinery, audit	17/09/2007	04/12/2007	04/06/2008
13.009	04	Quality system documentation, quality management manual, certificates, audit reports, language	17/09/2007	10/06/2008	08/01/2009
13.010	04	Technical design specification, sample, manufacturing facilities, inspections, audit plan	17/09/2007	10/06/2008	08/01/2009
13.011	04	Harmonized standards, responsibility, design review	17/09/2007	10/06/2008	08/01/2009
13.012	05	Design inspection, design verification, independence, level of confidence	23/10/2012	10/06/2008	08/01/2009
13.013	03	Product complexity, validation, competence	17/09/2007	04/12/2007	04/06/2008
13.014	04	Competency qualification of personnel, product specific requirements	17/09/2007	10/06/2008	08/01/2009
13.015	04	Machinery design, quality, compliance	17/09/2007	10/06/2008	08/01/2009
13.016	05	Existing certification, conformance, certified quality system	23/10/2012	10/06/2008	08/01/2009
13.017	02	Auditors, experts, competence	17/09/2007	04/12/2007	04/06/2008
13.018	02	EHSR, technical file, review	17/09/2007	04/12/2007	04/06/2008
13.019	04	Product changes, changes of quality system, significant changes, contract	17/09/2007	10/06/2008	08/01/2009
13.020	04	Notification, report, certificate	17/09/2007	10/06/2008	08/01/2009
13.021	04	Audit frequency and duration, surveillance audits	17/09/2007	10/06/2008	08/01/2009
13.022	02	Unannounced visits, contracts	17/09/2007	04/12/2007	04/06/2008
13.023	04	Obligation to preserve	12/05/2009	10/06/2009	25/12/2009
13.024	04	Obligation to preserve, quality assurance system documentation	17/09/2007	10/06/2008	08/01/2009
13.025	04	Last date of manufacture	17/09/2007	10/06/2008	08/01/2009
13.026	02	audit frequency and duration, assessment	17/09/2007	04/12/2007	04/06/2008
13.028	03	technical file, sample, manufacturing facilities, inspections, audit plan	17/09/2007	10/06/2008	08/01/2009
13.029	03	Subcontract	21/08/2008	09/12/2008	18/06/2009
13.030	03	Reassessment	21/08/2008	09/12/2008	18/06/2009
13.031	04	Annex X	12/05/2009	10/06/2009	25/12/2009
13.033	04	Quality system, audit plan	23/10/2012	09/12/2008	18/06/2009
13.034	04	Certificate	12/05/2009	10/06/2009	25/12/2009

Number CNB/M/ (1)	Revision (Rev)	Key words	Approved by Vertical Group of NBs⁽²⁾ on:	Approved by Horizontal Committee of NBs⁽²⁾ on:	Endorsed by Machinery Working Group on:
13.035	04	Annex X	12/05/2009	10/06/2009	25/12/2009
13.037	03	Surveillance, quality system, technical file	12/05/2009	10/06/2009	25/12/2009
Vertical Group 14 – Portable cartridge-operated fixing and other impact machinery					
14.001	03	Bolt setting devices, Cattle stunners, other hand held cartridge operated fixing and impact machinery	11/12/2013	18/06/2014	08/01/2015

(1): CNB/M/xx.xxx RERev yy = Coordination of Notified Bodies/Machinery/Numbering of the RfUs
R: Recommendation for Use E: English version Rev: Revision yy: index of the Revision

(2): NBs = Notified Bodies

	<p>CO-ORDINATION OF NOTIFIED BODIES Machinery Directive 2006/42/EC + Amendment</p> <p>RECOMMENDATION FOR USE</p>		<p>CNB/M/01.029 Revision 05 Language: E</p>
<p>Date of first stage: 24/05/2000</p>	<p>To be approved by:</p>		<p>Approved on:</p>
<p>Origin: VG1 Woodworking machinery</p>	<p><input checked="" type="checkbox"/> Vertical Group</p> <p><input checked="" type="checkbox"/> Horizontal Committee.....</p> <p>To be endorsed:</p> <p><input checked="" type="checkbox"/> Machinery Working Group.....</p>		<p>24/04/2009 09/12/1998</p> <p>Endorsed on: 03/03/2000</p>
<p>Question related to: Directive 2006/42/EC</p> <p>Annex: I ESR (1): 1.2.3; 1.2.4</p>	<p>EN/prEN:</p> <p>Clause:</p> <p>CEN TC concerned : TC 142</p>		<p>Other:</p>
<p>Key words: tractor driven machine, P.T.O.</p>			
<p>Question: Could the start and stop controls for the machine actuator (e.g. tractor) be regarded as the start and stop controls of the woodworking machine?</p>			
<p>Solution:</p> <p>No. At least a stop control device shall be fitted at the operators position, unless an harmonised standard in line with article 5.2 does not require this control</p> <p>Adaptation procedure: FORMAL ADAPTATION IN CONFORMITY WITH DIRECTIVE 2006/42/EC</p>			

(1) Essential safety requirement

Note: According to point 6.6 of the Guide of the implementation of directives based on the New Approach and the Global Approach, the notified bodies apply as general guidance this recommendation for use

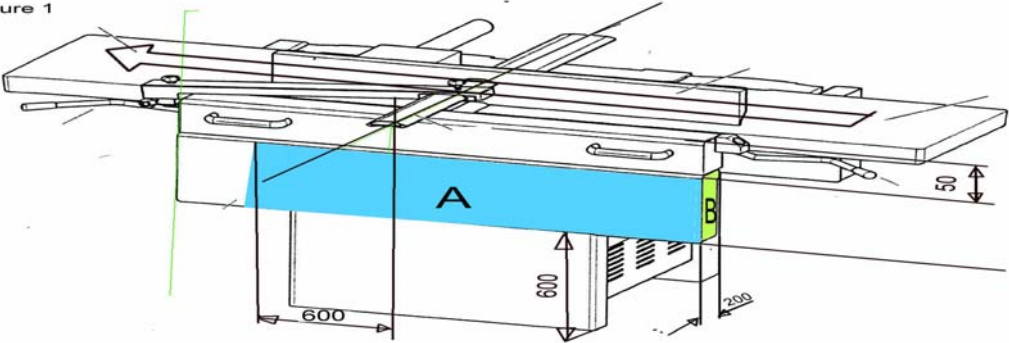
	CO-ORDINATION OF NOTIFIED BODIES MACHINERY DIRECTIVE 2006/42/EC + Amendment RECOMMENDATION FOR USE	CNB/M/01.073 Revision: 03 Language: E
Date of first stage: 18/04/2008 Origin: VG1 Woodworking machinery	To be approved by: <input checked="" type="checkbox"/> Vertical Group <input checked="" type="checkbox"/> Horizontal Committee..... To be endorsed by: <input checked="" type="checkbox"/> Machinery Working Group.....	Approved on: 24/04/2009 10/06/2007 Endorsed on: 03/03/2008
Question related to: Dir. 2006/42/EC Article: Annex: I EHSR (1): 1.2.2	EN/prEN: EN 861: 2008 Normative clause: 5.2.2 CEN TC concerned: TC 142	Other: Other clause:
Key words: Surface planing and thickening machines, position of controls.		
<p>Question:</p> <p>In clause 5.2.2 of prEN 861 is required, that the electric control actuator for starting, normal stopping, emergency stop and powered table adjustment shall be placed either:</p> <p>.....</p> <p>a) on the machine at the <u>infeed side</u> of the machine at least 600 mm from the floor and at least 50 mm below the upper surface of the surfacing table reachable from the <u>infeed side of the thicknesser</u>, or</p> <p>b) at a fixed or moveable control panel fixed to the machine at the loading position, the controls of which are not more than 1.800 mm from the floor and the front face is at a maximum of 650 mm from the infeed edge. The front face of the panel shall not protrude beyond the machine at the operator position side.</p> <p>.....</p> <p>1) Is the “infeed side” in the beginning of clause a) identical with the “infeed side of the thicknesser” mentioned later on?</p> <p>2) How to verify the requirement in a) that the control actuators shall be reachable from the infeed side of the thicknesser?</p>		
<p>Solution:</p> <p>1) It is not clear what is really meant. The goal of the requirement is to satisfy the essential safety requirements of Directive 98/37/EC, Annex I, 1.2.2. It is required that operating the control actuators shall be possible from all working positions of the operator. This is achieved by positioning the control actuators as described in answer 2).</p> <p>2) It is not clear enough to require only “reachability” of the control actuators. The actuators shall be reachable with regard to ergonomic principles. This is fulfilled when for the planing mode the control actuators for starting, normal stopping, emergency stop, powered table adjustment are located in area A or B shown in fig. 1.</p> <div style="text-align: center;"> <p>Figure 1</p>  </div>		

(1) Essential health and safety requirement

Note: According to point 6.6 of the Guide of the implementation of directives based on the New Approach and the Global Approach, the notified bodies apply as general guidance this recommendation for use.

In thickening mode this is fulfilled if the control actuators for starting, normal stopping, emergency stop are located in area C or D shown in fig. 2.

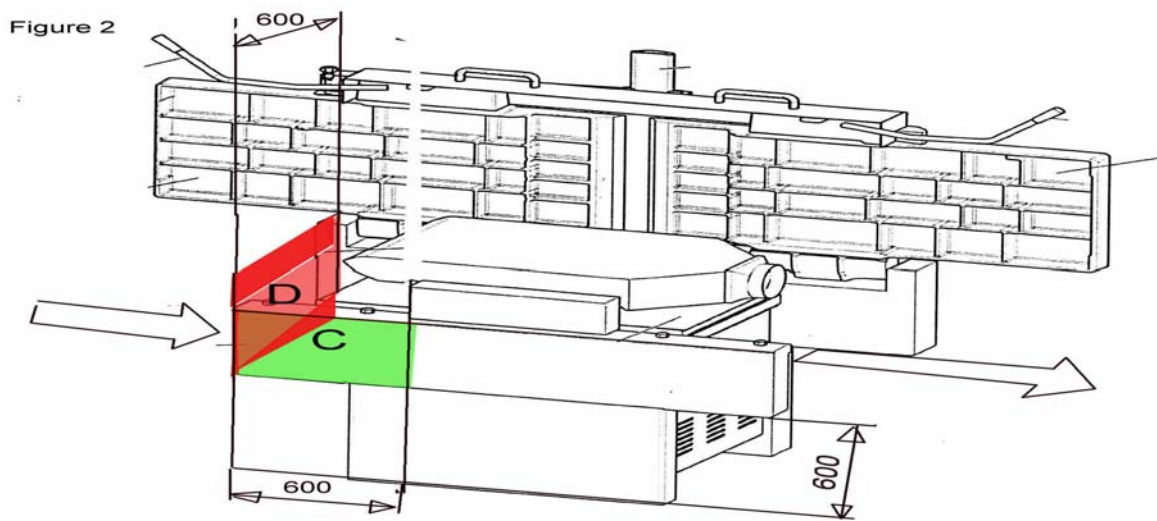

If the position of the control actuators are located in the overlapping area of A and C, then one single set of control actuators on the machine is sufficient.

**Adaptation procedure: FORMAL ADAPTATION IN CONFORMITY WITH
DIRECTIVE 2006/42/EC**

	CO-ORDINATION OF NOTIFIED BODIES Machinery Directive 2006/42/EC + Amendment RECOMMENDATION FOR USE	CNB/M/01.081 Revision 02 Language: E									
Date of first stage: 05/05/2009	To be approved by:	Approved on:									
Origin: VG1 Woodworking machinery	<input checked="" type="checkbox"/> Vertical Group	23/04/2010									
	<input checked="" type="checkbox"/> Horizontal Committee	15/06/2010									
Question related to: Directive 2006/42/EC Article: Annex: I ESR (1): 2.3	To be endorsed by:	Endorsed on:									
	<input checked="" type="checkbox"/> Machinery Working Group....	30/12/2010									
EN/prEN: 848-1:2007+A1:2009	Other:										
Clause: 5.3.6.1.2.1	Other clause: Table 4										
GEN TC concerned: TC 142, CENELEC TC 116											
Key words: Single spindle vertical moulding machines, table insert rings.											
<p>Question:</p> <p>At table 4 the minimum inner diameter of the smallest table insert ring is shown with 65 to 75^a mm. The remark ^{a)} concerns machines with exchangeable spindle only.</p> <p>In such manner spindle diameters > 40 mm cannot be used at machines with fixed spindle because the spindle rings with a wall thickness of at least 9,75 mm would prevent the using.</p> <table border="0" data-bbox="151 1064 957 1164"> <tr> <td>For example:</td> <td>fixed spindle with diameter 50 mm</td> <td style="text-align: right;">50,00 mm</td> </tr> <tr> <td></td> <td>plus two times wall thickness of the spindle rings</td> <td style="text-align: right;">19,50 mm</td> </tr> <tr> <td></td> <td>total</td> <td style="text-align: right;">69,50 mm</td> </tr> </table> <p>So, the inner diameter of the smallest table insert ring of 65 mm would be too narrow.</p>			For example:	fixed spindle with diameter 50 mm	50,00 mm		plus two times wall thickness of the spindle rings	19,50 mm		total	69,50 mm
For example:	fixed spindle with diameter 50 mm	50,00 mm									
	plus two times wall thickness of the spindle rings	19,50 mm									
	total	69,50 mm									
<p>Solution:</p> <p>The remark ^{a)} at table 4 should be cancelled to extend the inner diameter of the smallest table insert ring to 75 mm for machines with fixed spindle too.</p>											

(1) Essential safety requirement

Note: According to point 6.6 of the Guide of the implementation of directives based on the New Approach and the Global Approach, the notified bodies apply as general guidance this recommendation for use.

	CO-ORDINATION OF NOTIFIED BODIES Machinery Directive 2006/42/EC + Amendment RECOMMENDATION FOR USE	CNB/M/01.082 Revision 02 Language: E
Date of first stage: 10/06/2009	To be approved by:	Approved on:
Origin: VG1 Woodworking Machinery (on request of the European Commission-Machinery Working Group)	<input checked="" type="checkbox"/> Vertical Group	23/04/2010
	<input checked="" type="checkbox"/> Horizontal Committee	15/06/2010
Question related to: Directive 2006/42/EC Article: Annex: I ESR (1): 2.3 (c)	EN/prEN: several standards for woodworking machinery Clause: CEN TC concerned: CEN TC 142, CENELEC TC 116	Other: Other clause:
Key words: Small woodworking machines with electric brake		
<p>Question:</p> <p>Clause 2.3 (c) of Annex I requires for woodworking machines:</p> <p style="padding-left: 40px;">.... the machinery must be equipped with an automatic brake that stops the tool in a sufficiently short time if there is a risk of contact with the tool whilst it runs down;</p> <p style="padding-left: 40px;">....</p> <p>Woodworking machines as circular saw benches or single spindle moulders are machines, where "there is a risk of contact with the tool whilst it runs down". As "a sufficiently short time" for stopping the tool when activating the stop control 10 s maximum are allowed normally in the relevant standards e.g. EN 1870-1:2007, EN 848-1:2007, EN 61029-1:2009/EN 61029-2-1:2008.</p> <p>Small machines may have a flexible cord with a plug or a plug/socket combination for connection to electric power. An electric brake -if fitted- will not come effective when the machine is stopped by unplugging.</p> <p>How shall NBs evaluate in EC type-tests the possibility of stopping such machines by unplugging?</p>		
<p>Solution:</p> <p>The requirements in 1.2.2 and 1.2.4 of Annex I of 2006/42/EC demand a stop control which is easily to reach from operator's position. Corresponding to these requirements the relevant standards as EN 1870-1:2007, EN 848-1:2007, EN 61029-1:2009/EN 61029-2-1:2008 define the position of the stop control very precisely.</p> <p>Stopping the machine by using the stop control provided seems to be much more comfortable than by unplugging:</p> <ul style="list-style-type: none"> • the stop control is close to the operator's place, • disconnecting the socket from the plug/socket combination is rather uncomfortable, • there is no inducement for the operator to bypass the provided stop control. <p>Where the stop control is positioned on woodworking machines as required in the relevant standard, stopping by unplugging is not completely excluded, but not very likely to be expected. In EC type-tests the NBs shall verify the requirements of the standard regarding position of stop control.</p>		

(1) Essential safety requirement

Note: According to point 6.6 of the Guide of the implementation of directives based on the New Approach and the Global Approach, the notified bodies apply as general guidance this recommendation for use.

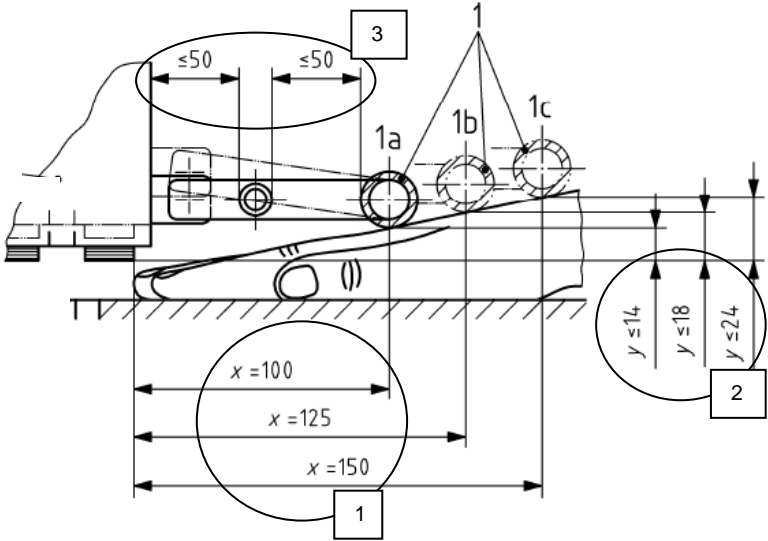
	CO-ORDINATION OF NOTIFIED BODIES Machinery Directive 2006/42/EC + Amendment RECOMMENDATION FOR USE	CNB/M/01.083 Revision 02 Language: E
Date of first stage: 23/04/2010 Origin: VG1 Woodworking machinery	To be approved by: <input checked="" type="checkbox"/> Vertical Group <input checked="" type="checkbox"/> Horizontal Committee To be endorsed by: <input checked="" type="checkbox"/> Machinery Working Group....	Approved on: 23/04/2010 15/06/2010 Endorsed on: 30/12/2010
Question related to: Directive 2006/42/EC Article: Annex: I ESR (1): 1.4.1, 1.4.3	EN/prEN: EN 1870-13:2007+A1:2009 Clause: 5.3.6.3 CEN TC concerned: TC 142	Other: Other clause:
Key words: Safeguarding of the pressure beam: trip bar – design and dimensions.		
<p>EN 1870-13 requires in clause 5.3.6.3 safeguarding of the pressure beam: Access to the crushing ... zone ... shall be avoided by providing a mechanically actuated trip device (trip bar) ... The mechanically actuated trip device (trip bar) shall be in accordance with the following requirements : ... c) its dimensions shall be in accordance with Figure 5; ...</p>  <p>Figure 5 – Dimensions of trip bar – shows the trip bar in three different horizontal distances ($x=100$ mm, $x=125$ mm and $x=150$ mm) from the edge of the pressure beam [1]. Furthermore maximum dimensions are shown for the vertical distance of the trip bar from that edge [2]. In addition, there is shown a maximum horizontal dimension of 50 mm related to the distance between lateral bars mounted within the area between the pressure beam and the trip bar [3].</p> <p>Question:</p> <p>a) Is the mechanically actuated trip bar mandatory or is another guard possible and tolerable (e. g. AOPD or sensors based on other physical principles)?</p> <p>b) If a mechanically actuated trip bar is provided, is it acceptable to differ in design and dimensions from the shown figure?</p>		

(1) Essential safety requirement

Note: According to point 6.6 of the Guide of the implementation of directives based on the New Approach and the Global Approach, the notified bodies apply as general guidance this recommendation for use.

Solution:

- a) A mechanically actuated trip bar is not mandatory. Any other guard resulting in the same level of protection is allowed. Although not yet been put in practice by any manufacturer a guarding of the pressure beam is possible with other systems not being mechanically actuated as well. Such systems have been developed for different kinds of machines (hydraulic press brake, calender) and are working reliably.
- b) **1**: EN 1870-13:2007 defines a remaining clearance between the pressure beam and the table surface (min. 12 mm) when stopped by a distance block of determined height. The height depends on the position of the trip bar relative to the pressure beam. The three dimensions $x = 100 \text{ mm}$, 125 mm or 150 mm and their related heights are useful to reflect the wedge-shaped profile of a human hand. Greater distances x or different positions (min. 100 mm) are possible and are realisable without reduction of safety. However, it is required to use the block height according to the next smaller position and reach the required clearance (example: $x = 140 \text{ mm} \Rightarrow$ choose block height = 30 mm as for 125 mm ; $x = 200 \text{ mm} \Rightarrow$ block height = 36 mm as for 150 mm . No interpolation is allowed!).
- 2**: Dimension Y in figure 5 is of no relevance. It relates to the contact path of the trip bar, which can be individually designed by the manufacturer, as long as the functional requirements are fulfilled.
- 3**: The given dimensions of figure 5 originate from rules, stated by the Holz-Berufsgenossenschaft in 1981 for single saw blade machines with pressure beam. The first machines of this kind normally did not have a safety curtain and the pressure beam was reachable from both sides. Therefore the cutting area was easily accessible even when the pressure beam was in closed position resting on the workpiece. The lateral bars with a distance from max. 50 mm to each other should prevent the access to the pressure beam and the cutting area from the top side. However, this dimension is not in accordance with the current requirements of EN 13857:2008 table 4 any more. With the commencement of EN 1870-13:2007 a safety curtain became mandatory. With this curtain the lateral bars are not necessary any more. They can or cannot be realised.

	CO-ORDINATION OF NOTIFIED BODIES Machinery Directive 2006/42/EC + Amendment RECOMMENDATION FOR USE	CNB/M/01.084 Revision 02 Language: E
Date of first stage: 02/08/2010	To be approved by:	Approved on:
Origin: VG1 Woodworking machinery	<input checked="" type="checkbox"/> Vertical Group <input checked="" type="checkbox"/> Horizontal Committee To be endorsed by: <input checked="" type="checkbox"/> Machinery Working Group....	04/11/2010 14/12/2010 Endorsed on: 04/07/2012
Question related to: Directive 2006/42/EC Article: Annex: IV ESR (1): 2.3	EN/prEN: Clause: GEN TC concerned: CEN TC 142 and CENELEC TC 116	Other: Other clause:
Key words: Rigid PVC; material with similar physical characteristics to wood.		
Question: Annex IV of 2006/42/EC covers some categories of machinery for “working with wood and material with similar physical characteristics“. Parameters for machining rigid PVC (unplasticised PVC) are very similar to those for machining wood regarding cutting speed, machining tools, cutting force, clamping of the work piece. Machines mentioned in clauses 1., 4., 5., and 7. of Annex IV are used for working with wood as well as for working with rigid PVC. <ul style="list-style-type: none"> a) Is rigid PVC as used e.g. for manufacturing of windows frames such a material with similar physical characteristics to wood? b) Are machines mentioned in clauses 1., 4., 5., and 7. of Annex IV for machining rigid PVC covered by Annex IV? 		
Solution: <ul style="list-style-type: none"> a) Yes. There is no doubt that rigid PVC is a material with similar physical characteristics to wood. See § 388 of Guide to application of the Machinery Directive 2006/42/EC 2nd Edition, June 2010: “Materials analogous to wood include, for example, chipboard, fibreboard, plywood (and also these materials when they are covered with plastic or light alloy laminates), cork, bone, rigid rubber or plastic...” b) Yes. Machines mentioned in clauses 1., 4., 5., and 7. of Annex IV for machining rigid PVC are covered by Annex IV. 		

(1) Essential safety requirement

Note: According to point 6.6 of the Guide of the implementation of directives based on the New Approach and the Global Approach, the notified bodies apply as general guidance this recommendation for use.

	CO-ORDINATION OF NOTIFIED BODIES Machinery Directive 2006/42/EC as amended RECOMMENDATION FOR USE		CNB/M/01.087 Revision 05 Language : EN
Number of pages : 1	Date : 04/05/2012	To be approved by :	Approved on :
Origin : VG1 Woodworking machinery		x Vertical Group..... x Horizontal Committee..... To be endorsed by: x Machinery Working Group.....	21/05/2014 18/06/2014 Endorsed on : 08/01/2015
Question related to : 2006/42/EC	Article :	EN ISO 11681-2 EN 60745-1, EN 60745-2-13	Other : -
Annex : IV	ESR (1):	Normative clause : - CEN TC concerned : -, CENELEC TC 116	Other clause : -
Key words : Chain saws for tree service/top handle machine, electric powered			
<p>There is no harmonized C-standard available for those machines: Type testing on the basis of EN 60745-1 and EN 60745-2-13 would not satisfy the safety requirements for battery powered chain saws for tree service / top handle machines. The standard EN ISO 11681-2 is restricted to gasoline engines only.</p> <p>Question: What standard(s) can alternatively be used for type testing of electric powered chain saws for tree service / top handle machines?</p>			
<p>Solution :</p> <p>Note: <i>Mains powered chain saws are rather dangerous for tree service due to the power supply cable and can cause hazards if the worker is working in and on the tree; therefore this RfU is handling only battery powered machines.</i></p> <p>Battery powered chain saws for tree service / top handle machines with a maximum mass *) of 4.5 kg including the heaviest available battery for these machines can be type tested according to the relevant paragraphs of: EN 60745-1 in conjunction with EN 60745-2-13 for the electrical requirements and EN ISO 11681-2 for non-electrical requirements, following the normative references within these standards.</p> <p>*) empty oil tank and without guide bar and chain as defined in EN ISO 11681-2</p>			

(1) Essential safety requirement

Note : According to point 6.6 of the Guide of the implementation of directives based on the New Approach and the Global Approach, the notified bodies apply as general guidance this recommendation for use.

	CO-ORDINATION OF NOTIFIED BODIES Machinery Directive 2006/42/EC as amended RECOMMENDATION FOR USE		CNB/M/01.089 Revision 03 Language : EN
Number of pages : 1	Date : 21/05/2014	To be approved by :	Approved on :
Origin : VG1 Woodworking machinery		x Vertical Group..... x Horizontal Committee..... To be endorsed by: x Machinery Working Group.....	21/05/2014 18/06/2014 Endorsed on : 08/01/2015
Question related to : 2006/42/EC	Article :	Other : -	
Annex : IV	ESR (1): 1.2.6	Normative clause : -	Other clause : -
Key words : Electric and electronic brakes, run-down time, failure of power supply			
<p>Clause 1.2.6 of the machinery directive 2006/42/EC states: The interruption, the re-establishment after an interruption or the fluctuation in whatever manner of the power supply to the machinery must not lead to dangerous situations.</p> <p>More and more machines for wood working have electric or electronic brakes for the tool drive motor. Most of these brakes do not work without power supply. When there is a failure in the power supply during normal operation, the tool spindle is non-braked and the run-down time may be much higher than the acceptable run-down time outlined in the specific machine standard (mostly 10 s). E. g. on single spindle molding machines non-braked run-down times of several minutes may be possible with large and heavy tools.</p> <p>Note: <i>The same situation occurs, if the stop is performed in stop category 0 due to a failure in the logic of an electronic brake.</i></p> <p>Question:</p> <p>a) Is the situation as described above acceptable or is a fall-back solution for power supply failures, e. g. mechanical brake or braking by UPS or energy recuperation necessary to achieve the required run-down time?</p>			
<p>Solution :</p> <p>Note: <i>No further regulation is necessary, if tool access is prevented by fixed or moveable interlocked guards with guard locking (as far as locking needs power supply to be opened). On the other hand there are many Annex IV woodworking machines having only adjustable guards in some sections of the non-cutting part and no guarding at all for the cutting part of the tool. Only for these machines with unguarded access to the tool and which usually require a braked run-down time of not more than 10 seconds, the following applies.</i></p> <p>The risk assessment by CEN/TC 142/WG 1 and CENELEC/TC 116 lead to the conclusions that</p> <ul style="list-style-type: none"> - the probability of an accident due to uncontrolled run-down of tools after a failure in the energy supply of the machine is extremely low (low probability of uncontrolled run-down and low probability of deliberate access to tools at the same time) - the possible damage is high - the resulting risk is very low and thus acceptable. <p>The situation is <u>acceptable</u> since power supply failure is a seldom and specific situation that can be managed by the operator. He/she is aware of the dangerous situation and will handle any further manipulation on the machine with care.</p> <p>In order to reduce the risk, one or more warning labels in close proximity to the danger zone(s) stating that tool brake(s) may not operate effectively in the case of power supply failure should be required.</p> <p>Note: <i>A failure in the brake device logic is even more seldom. The standards in TC 142 require a stop category 0 (without braking) in this situation. Any further regulation for this situation is not reasonable.</i></p>			

(1) Essential safety regulations

Note: According to point 6.6 of the Guide of the implementation of directives based on the New Approach and the Global Approach, the notified bodies apply as general guidance this recommendation for use.

	<p>CO-ORDINATION OF NOTIFIED BODIES Machinery Directive 2006/42/EC + Amendment</p> <p>RECOMMENDATION FOR USE</p>	<p>CNB/M/02.001 Revision 02</p> <p>Language: E</p>
Date of first stage: 17/11/2011	To be approved by:	
Origin: VG2 Meatworking machinery	<input checked="" type="checkbox"/> Vertical Group <input checked="" type="checkbox"/> Horizontal Committee	<p>Approved on:</p> <p>17/11/2011 13/12/2011</p>
<p>Question related to: Directive 2006/42/EC Article:</p> <p>Annex: I ESR (1): 1.4.1, 1.4.2.3</p>		<p>EN/prEN: EN 12268:2003+A1:2010 Other:</p> <p>Clause: 5.2.4 Other clause:</p> <p>CEN TC concerned: TC 152</p>
Key words: adjustable guards		
<p>Question:</p> <p>Concerning the last slice device, § 5.2.4 of EN 12268 states the following:</p> <p>A last slice device of a height ≥ 150 mm shall be provided. The last slice device may be provided with spices on the side facing to the saw blade. The last slice device may be removable.</p> <p>Is there enough information for satisfactory construction built of a safety last slice device?</p>		
<p>Solution:</p> <p>No, there is not enough information.</p> <p>The following interpretation is acceptable:</p> <ul style="list-style-type: none"> - A last slice device shall be delivered with the machine. - The last slice device shall have a height ≥ 150 mm and a length of ≥ 200 mm. - The last slice device may be tiltable and removable. - The last slice device may have spices on the side facing to the saw blade. Contact with the saw blade shall be prevented. <p>Additionally a description on how to handle meat or bones, longer or higher than the last slice device, when using the last slice device, shall be added in the instructions for use (complement of § 7.2. c of EN 12268)</p>		

(1) Essential safety requirement

Note: According to point 6.6 of the Guide of the implementation of directives based on the New Approach and the Global Approach, the notified bodies apply as general guidance this recommendation for use.

	CO-ORDINATION OF NOTIFIED BODIES Machinery Directive 2006/42/EC + Amendment RECOMMENDATION FOR USE	CNB/M/03.002 Revision: 15 Language: E
Date of first stage: 24/09/1996	To be approved by:	Approved on:
Origin: VG3 Presses for cold working metals	<input checked="" type="checkbox"/> Vertical Group <input checked="" type="checkbox"/> Horizontal Committee..... To be endorsed by: <input checked="" type="checkbox"/> Machinery Working Group.	30/09/2009 12/12/1995 Endorsed on: 04/06/1996
Question related to: Dir. 2006/42/EC Article: Annex: IV-9 EHSR (1):	EN/prEN: Normative clause: CEN TC concerned:	Other: Other clause:
Key words: Presses - Metal - Field of application		
Question: Which categories of metal presses are referred to in Annex IV A, point 9, of the "machines"?		
Recommended Solution: 1) By cold working it is understood that there is a possibility of the operator placing (loading) and/or removing (unloading) workpieces between the tools with his hands. 2) By metal, it is understood to be a material, either in sheet, rolled conditions, or forged form. Powders, not necessarily metallic, irons, and concrete meshes are excluded from this definition. 3) By cold metal working it is understood to be a transformation process either by folding, stamping, or cutting, etc. Only presses who's movable working parts are driven by an alternative movement having the two following constructional characteristics are referred to: - a travel of greater than 6 mm, - a closing speed superior to 30 mm/sec. (see CNB/M/3/042) Regarding mechanical presses, the instantaneous speed reached by the movable working parts at the mid-point of their travel during their ascent and descent should be taken into consideration, as it is maximum in either of these positions.	4) exclusion from annex IV A for the machines who's principal purpose is: - sheet metal cutting by guillotine (guillotine shears), - attaching a fastener, e. g. riveting, stapling or stitching, fastening etc...(erection, dismantling machines), - assembling e. g. bearing (simple assembling presses), - bending or folding (bending machines, bending presses), - calibrating, - straightening (straightening presses, planing presses), - turret punch pressing (punching and nibbling machines), - extruding (extruder presses), - drop forging or drop stamping, - compaction of metal powder (presses for compacting powders), - punching (punching machines), - blow forging (blow forging presses), - isostatic forming (isostatic presses for metal powder, for complex parts of sheet material) Note 1: Hot working of metals is understood if the operator is forced to use tongs or grippers etc. for handling of hot metals (workpieces) so that his hands are outside of the tools area and cannot be injured. Note 2: If hot metals (workpieces) are placed or removed by hand between the tools without ancillary devices, it is understood as cold working of metals.	
Adaptation procedure: FORMAL ADAPTATION IN CONFORMITY WITH DIRECTIVE 2006/42/EC		

(1) Essential health and safety requirement

Note: According to point 6.6 of the Guide of the implementation of directives based on the New Approach and the Global Approach, the notified bodies apply as general guidance this recommendation for use.

	CO-ORDINATION OF NOTIFIED BODIES Machinery Directive 2006/42/EC + Amendment RECOMMENDATION FOR USE	CNB/M/03.004 Revision: 06 Language: E
Date of first stage: 13/12/1995 Origin: VG3 Presses for cold working metals	To be approved by: <input checked="" type="checkbox"/> Vertical Group <input checked="" type="checkbox"/> Horizontal Committee..... To be endorsed by : <input checked="" type="checkbox"/> Machinery Working Group...	Approved on: 30/09/2009 12/12/1995 Endorsed on : 04/06/1996
Question related to: Dir. 2006/42/EC Article: Annex: VI point 2 EHSR (1):	EN/prEN: Normative clause: CEN TC concerned:	Other: Other clause:
Key words: Technical file		
Question: What shall be the contents of a press technical file?		
Solution: The content of the technical file is defined by annex VI point 2 of the directive. It may particularly understand : <u>1st dash</u> (related to the annex VI point 2 about the technical file) - Dimensions of the machine related to the protective means (general drawings with dimensions of accesses to the dangerous parts), - Location diagram of the electrical components on the press (in the cabinet, on the frame...) - Location diagram of the hydraulic and pneumatic components <u>2nd dash</u> - Functional schemes of the control circuits (hydraulic, electric, pneumatic, mechanic...), - Description of the time sequences, e.g. functional characteristics of the valves - Diagrams for cams, selector switches, - A components list with data sheets and instructions for use of certified safety components. - Drawings of the guards (dimensions, material, cams, attachments...), - Drawings of the power flow related to the safety (flywheel, slide, piston, ejectors, handling devices...), - Positioning of the controls (selector switches, emergency stops, pedal...), - Positioning of the guards and the protective devices to check the possibilities of accesses, - Calculations or references about experiences with well tried components..., (see separate technical sheet n° ...) - Declaration of conformity for safety components. - Notes, results, tests (for example stopping time) - Declaration of conformity with the EMC directive from the 1 st /01/96 (see CNB/M/006/R and CNB/M/3/021/R) - Declaration of conformity with the low voltage directive from the 1 st /01/97 (see CNB/M/3/067/R) - Declaration of conformity with others related directives concerning hazardous aspects		

(1) Essential safety requirement

Note: According to point 6.6 of the Guide of the implementation of directives based on the New Approach and the Global Approach, the notified bodies apply as general guidance this recommendation for use.

3rd dash

As parts of the risk assessment, the designer shall verify whether the list of hazards in table 1 of Pr EN692, 693, ... is exhaustive and applicable to the press under consideration.

If additional hazard is identified the risk assessment has to be carried out and the measures taken to eliminate or reduce this risk shall to be described

4st dash

Recommendation for the handbook:

- Where the protective means are described, the associated safety instructions shall be also given and highlighted.

It shall be, at least, one clause containing safety instructions, with reference to the description of the protective devices.

- The instruction handbook may give additional information.

5st dash

See technical sheet CNB/M/00.240/R/E (03.003).

**Adaptation procedure: FORMAL ADAPTATION IN CONFORMITY WITH
DIRECTIVE 2006/42/EC**

	CO-ORDINATION OF NOTIFIED BODIES Machinery Directive 2006/42/EC + amendment RECOMMENDATION FOR USE		CNB/M/03.005 Revision 03 Language: E
Date of first stage: 10/06/1996	To be approved by:		Approved on:
Origin: VG3 Presses for cold working metals	<input checked="" type="checkbox"/> Vertical Group		30/09/2009
	<input checked="" type="checkbox"/> Horizontal Committee.....		17/04/1996
To be endorsed by :			Endorsed on :
<input checked="" type="checkbox"/> Machinery Working Group.			08/06/1998
Question related to: Dir. 2006/42/EC	Article:	EN/prEN:	Other:
Annex:	EHSR (1): 1.6.2	Normative clause:	Other clause:
CEN TC concerned:			
Key words: Platform, ladders			
<p>Question:</p> <p>E.S.R. 1.6.2 requires a manufacturer of a press, to provide means of access to the servicing points (for maintenance reasons too) :</p> <p>Do those requirements force the manufacturer to provide every type of press with a platform at the top and ladders for access, to work safely in maintenance operations?</p> <p>In which conditions this E.S.R. may be considered non applicable?</p>			
<p>Solution:</p> <p>Adjustments, inspections, lubrication on raised workstation (top of the press...) shall require a platform and a permanent access. For only repair, no platform is required.</p> <p>Adaptation procedure: FORMAL ADAPTATION IN CONFORMITY WITH DIRECTIVE 2006/42/EC</p>			

(1) Essential health and safety requirement

Note: According to point 6.6 of the Guide of the implementation of directives based on the New Approach and the Global Approach, the notified bodies apply as general guidance this recommendation for use.

	CO-ORDINATION OF NOTIFIED BODIES Machinery Directive 2006/42/EC + Amendment RECOMMENDATION FOR USE	CNB/M/03.013 Revision 08 Language: E
Date of first stage: 13/10/1997	To be approved by:	Approved on:
Origin: VG3 Presses for cold working metals	<input checked="" type="checkbox"/> Vertical Group	13/10/2010
	<input checked="" type="checkbox"/> Horizontal Committee	14/12/2010
Question related to: Directive 2006/42/EC Article: 5 Annex: IX ESR (1):	To be endorsed by:	Endorsed on:
	<input checked="" type="checkbox"/> Machinery Working Group....	23/05/2011
	EN/prEN:	Other:
	Clause:	Other clause:
	CEN TC concerned:	
Key words: Acceptability of components of type examined presses		
Question: If a: - two hand control device - active opto-electronic protective device - cyclic moving interlocking guard - rotary cam gear - control system - overrun detection - etc is examined within a EC Type-Examination of a press, should the results be respected and accepted by other notified bodies testing other presses (also of other press manufacturers) in relation to the above mentioned components ?		
Solution: Normally not. However, if there are separate certificates for single components, the following shall be taken in consideration : 1 - Certificates of notified bodies for safety components, established in Annex IV, shall be accepted by notified bodies for presses. 2 - Certificates of accredited Test and Certification bodies for (safety) components may be accepted by notified bodies for presses. Notes : - The notified body examining a press should have all the necessary technical data for installation and operation of the component. - This RfU is valid only for the safety components assessed under machinery Directive.		

(1) Essential safety requirement

Note: According to point 6.6 of the Guide of the implementation of directives based on the New Approach and the Global Approach, the notified bodies apply as general guidance this recommendation for use.

	CO-ORDINATION OF NOTIFIED BODIES Machinery Directive 2006/42/EC + amendment RECOMMENDATION FOR USE		CNB/M/03.027 Revision 06 Language: E
Date of first stage: 04/03/1996	To be approved by:	Approved on:	
Origin: VG3 Presses for cold working metals	<input checked="" type="checkbox"/> Vertical Group <input checked="" type="checkbox"/> Horizontal Committee..... To be endorsed by : <input checked="" type="checkbox"/> Machinery Working Group.	30/09/2009 19/09/1996 Endorsed on : 08/06/1998	
Question related to: Dir. 2006/42/EC Annex: I	Article: EHSR (1): 1.3.8.2.	EN/prEN: 692:2005+A1:2009 / 693:2001+A1:2009 Normative clause: 5.3.13 CEN TC concerned:	Other: Other clause:
Key words: Secondary protection /Two Hands Control Device / Active Optoelectronic Protective Devices			
Question: If a large press is safeguarded by light curtains and the tools area has to be entered by operators, which can be a sufficient protection? Normally, the table height is less than 750 mm, sometimes zero. Considering the recommended solution, may a single push button with monitoring and reset function be an acceptable level of protection?			
Solution: <ol style="list-style-type: none"> 1. The light curtain can act here only as a secondary protection measure to protect third persons. 2, Each operator has to use a two hand control device (THCD) type IIIC to initiate the stroke. 3, Each two hand control device requires a synchronous operation, the THCD's one with another require only simultaneous operation. <p>After an interruption of the light curtain, during the dangerous movement, the reset function has to be actuated before further movement can be initiated.</p> <p style="text-align: center;">Adaptation procedure: FORMAL ADAPTATION IN CONFORMITY WITH DIRECTIVE 2006/42/EC</p>			

(1) Essential health and safety requirement

Note: According to point 6.6 of the Guide of the implementation of directives based on the New Approach and the Global Approach, the notified bodies apply as general guidance this recommendation for use.

	CO-ORDINATION OF NOTIFIED BODIES MACHINERY DIRECTIVE 2006/42/EC + amendment RECOMMENDATION FOR USE	CNB/M/03.028 Revision 06 Language : E
Date of first stage: 31/10/1997 <hr/> Origin: VG3 Presses for cold working metals	To be approved by: <input checked="" type="checkbox"/> Vertical Group <input checked="" type="checkbox"/> Horizontal Committee..... To be endorsed by : <input checked="" type="checkbox"/> Machinery Working Group.	Approved on: 30/09/2009 18/09/1997 Endorsed on : 08/06/1998
Question related to: Dir. 2006/42/EC Article: Annex: I EHSR (1) : 1.3.7	EN/prEN: EN 692:2005+A1:2009 Other: Normative clause: 5.2.1.2.f) Other clause: CEN TC concerned: TC 143 WG1	
Key words: Failing of springs in the brake		
Question: How should verification of function with only 50% of the springs operating be carried out?		
Solution: If there is a spring assembly in a circular formation, 50% of only one side (180° of the core diameter) shall guarantee correct engagement of the brake. If this or a similar case occurs on a press, there will be an overrun of the crankshaft and the overrun detection device shall inhibit the initiation of a further stroke. The test shall be conducted in a way compatible for other spring arrangements. References: see CNB/M/03.073		
Adaptation procedure: FORMAL ADAPTATION IN CONFORMITY WITH DIRECTIVE 2006/42/EC		

(1) Essential health and safety requirement
 Note: According to point 6.6 of the Guide of the implementation of directives based on the New Approach and the Global Approach, the notified bodies apply as general guidance this recommendation for use.

	CO-ORDINATION OF NOTIFIED BODIES Machinery Directive 2006/42/EC + amendment RECOMMENDATION FOR USE		CNB/M/03.029 Revision 04 Language: E
Date of first stage: 13/10/1997	To be approved by:		Approved on:
Origin: VG3 Presses for cold working metals	<input checked="" type="checkbox"/> Vertical Group		30/09/2009
	<input checked="" type="checkbox"/> Horizontal Committee.....		12/12/1995
	To be endorsed by :		Endorsed on :
	<input checked="" type="checkbox"/> Machinery Working Group.		04/06/1996
Question related to: Dir. 2006/42/EC Article:	EN/prEN: 692:2005+A1:2009,	Other:	
Annex: I EHSR (1): 1.3.8	693:2001+A1:2009	Other clause:	
	Normative clause:		
	5.3.13 (692 Annex C)		
	CEN TC concerned: TC 143		
Key words: Reaching over, under and around the detection zone			
Question: Which tables of EN 13857 can be used to examine safety distances for reaching over, under and around the detection zone of a light Curtain?			
Solution: Reaching under and around the light curtain, tables 3, 4 and 6 shall be followed. Reaching over, table 1 may be used because there is no support for the arms by a physical guard; the light curtain will be interrupted using these correlating values.			
Adaptation procedure: FORMAL ADAPTATION IN CONFORMITY WITH DIRECTIVE 2006/42/EC			

(1) Essential health and safety requirement

Note: According to point 6.6 of the Guide of the implementation of directives based on the New Approach and the Global Approach, the notified bodies apply as general guidance this recommendation for use.

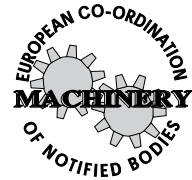
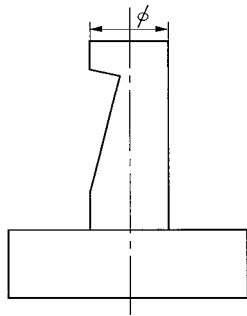
	CO-ORDINATION OF NOTIFIED BODIES Machinery Directive 2006/42/EC + amendment RECOMMENDATION FOR USE	CNB/M/03.032 Revision 04 Language: E
Date of first stage: 13/10/1997 Origin: VG3 Presses for cold working metals	To be approved by: <input checked="" type="checkbox"/> Vertical Group <input checked="" type="checkbox"/> Horizontal Committee To be endorsed by: <input checked="" type="checkbox"/> Machinery Working Group...	Approved on: 30/09/2009 12/12/1995 Endorsed on: 08/06/1998
Question related to: Dir. 2006/42/EC Article: Annex: I EHSR (1): 1.2.1, 1.3.2	EN/prEN: 692:2005+A1:2009 (1) Other: 693:2001+A1:2009 (2) Normative clause: 5.3.19.1 (1), Other clause: 5.3.17 (2) CEN TC concerned:	
Key words: Fixing the tools, failure of one component		
Question: Sometimes, single components are used to fix the tool (rod, latch, screw). Which requirements a single component has to fulfil? (see illustration)		
Solution: One screw with a nut for blocking up will be sufficient. Adequate strength has to be achieved.		
		
<p>Adaptation procedure: FORMAL ADAPTATION IN CONFORMITY WITH DIRECTIVE 2006/42/EC</p>		

(1) Essential health and safety requirement

Note: According to point 6.6 of the Guide of the implementation of directives based on the New Approach and the Global Approach, the notified bodies apply as general guidance this recommendation for use.

	<p style="text-align: center;">CO-ORDINATION OF NOTIFIED BODIES Machinery-Directive 2006/42/EC + amendment</p> <p style="text-align: center;">RECOMMENDATION FOR USE</p>		CNB/M/03.033 Revision 06 Language: E
Date of first stage: 24/09/1996	To be approved by:	Approved on:	
Origin: VG3 Presses for cold working metals	<input checked="" type="checkbox"/> Vertical Group <input checked="" type="checkbox"/> Horizontal Committee..... To be endorsed by: <input checked="" type="checkbox"/> Machinery Working Group.	30/09/2009 12/12/1995 Endorsed on: 08/06/1998	
Question related to: Dir. 2006/42/EC Annex: I	Article: EHSR (1): 1.3.8. 2	EN/prEN: 692:2005+A1:2009 693:2001+A1:2009 Normative clause: 5.3.1 CEN TC concerned: TC 143	Other: Other clause:
Key words: Protection measures, die cushion, blank holder and workpiece ejector control system			
Question: If there are dangerous movements of the die cushions and workpiece ejectors, in which kind/category the safety related parts of the control system shall be designed and constructed? (active actuation)			
Recommended solution: The dangerous/hazardous movements shall be initiated and stopped in an electrical, pneumatic or hydraulic circuit with redundancy (Cat. 3 of EN 954-1) NOTE: If there is the same risk created by the workpiece ejector, blank holder or die cushion as from the tooling then the same protection methods have to be applied (Cat. 4 of EN 954-1). Clear instructions for setting and the safe use of die cushion, blank holder and workpiece ejector have to be given in the instructions handbook.. Adaptation procedure: FORMAL ADAPTATION IN CONFORMITY WITH DIRECTIVE 2006/42/EC			

(1) Essential health and safety requirement

Note: According to point 6.6 of the Guide of the implementation of directives based on the New Approach and the Global Approach, the notified bodies apply as general guidance this recommendation for use.

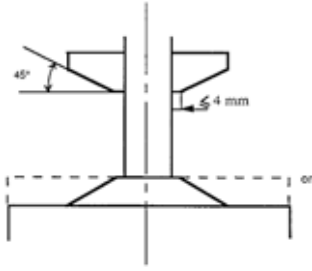
	CO-ORDINATION OF NOTIFIED BODIES MACHINERY DIRECTIVE 2006/42/EC + Amendment RECOMMENDATION FOR USE		CNB/M/03.035 Revision 04 Language: E
Date of first stage: 21/10/1996	To be approved by:		Approved on:
Origin: VG3 Presses for cold working metals	<input checked="" type="checkbox"/> Vertical Group	30/09/2009	
	<input checked="" type="checkbox"/> Horizontal Committee.....	12/12/1995	
	To be endorsed by:		Endorsed on:
	<input checked="" type="checkbox"/> Machinery Working Group.		04/06/1996
Question related to: Dir. 2006/42/EC Annex: I	Article: EHSR (1): 1.3.8	EN/prEN: 693:2001+A1:2009 Normative clause: 5.6 CEN TC concerned: TC 143 WG1	Other: Other clause:
Key words: crushing hazards, ram frame			
Question: Small hydraulic presses often create a crushing hazard between the frame (bottom of the cylinder) and the ram. Which method is appropriate to avoid the hazard?			
Solution: See attached figures 1 to 6 and table 1 of standard EN 349. If the head can be inserted, the distance shall be equal or more than 300 mm. (see CNB/M/03.034/R/E/Rev 03)			
<div style="text-align: center;">  </div> <p style="text-align: center;">Figure 1</p> <p>Adaptation procedure: FORMAL ADAPTATION IN CONFORMITY WITH DIRECTIVE 2006/42/EC</p>			

(1) Essential health and safety requirement

Note: According to point 6.6 of the Guide of the implementation of directives based on the New Approach and the Global Approach, the notified bodies apply as general guidance this recommendation for use.

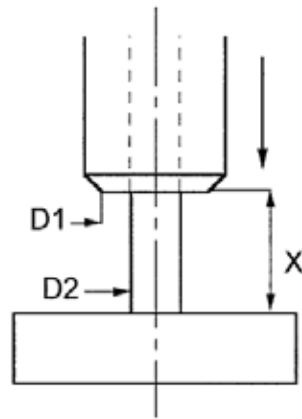

Figure 2

	D1 - D2	• 6 mm	X • 6 mm
6 mm <	D1 - D2	• 25 mm	X • 25 mm
25 mm <	D1 - D2	• 100 mm	X • 100 mm
100 <	D1 - D2		X • 100 mm
mm			

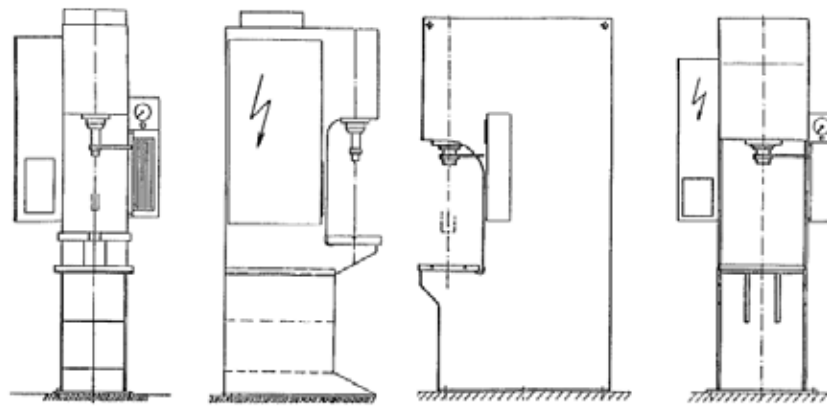

Figure 3

Figure 4

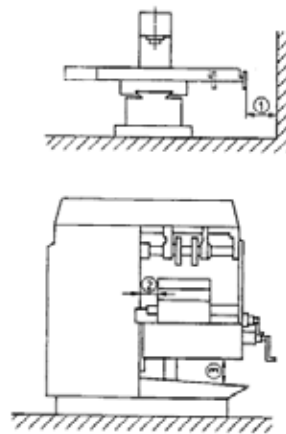



Figure 5



Figure 6 (Fig. A.1 from EN 349)

	CO-ORDINATION OF NOTIFIED BODIES MACHINERY DIRECTIVE 2006/42/EC + Amendment RECOMMENDATION FOR USE	CNB/M/03.068 Revision 07 Language : E								
Date of first stage: 10/06/1996		To be approved by: Approved on:								
Origin: VG3 Presses for cold working metals		<table border="0" style="width: 100%;"> <tr> <td data-bbox="874 436 1225 481"><input checked="" type="checkbox"/> Vertical Group</td> <td data-bbox="1225 436 1514 481" style="text-align: right;">30/09/2009</td> </tr> <tr> <td data-bbox="874 481 1225 526"><input checked="" type="checkbox"/> Horizontal Committee.....</td> <td data-bbox="1225 481 1514 526" style="text-align: right;">09/06/2005</td> </tr> <tr> <td colspan="2" data-bbox="874 548 1514 593" style="text-align: center;">To be endorsed by:</td> </tr> <tr> <td data-bbox="874 593 1225 633"><input checked="" type="checkbox"/> Machinery Working Group.</td> <td data-bbox="1225 593 1514 633" style="text-align: right;">Endorsed on: 29/10/2005</td> </tr> </table>	<input checked="" type="checkbox"/> Vertical Group	30/09/2009	<input checked="" type="checkbox"/> Horizontal Committee.....	09/06/2005	To be endorsed by:		<input checked="" type="checkbox"/> Machinery Working Group.	Endorsed on: 29/10/2005
<input checked="" type="checkbox"/> Vertical Group	30/09/2009									
<input checked="" type="checkbox"/> Horizontal Committee.....	09/06/2005									
To be endorsed by:										
<input checked="" type="checkbox"/> Machinery Working Group.	Endorsed on: 29/10/2005									
Question related to: Dir. 2006/42/EC Annex: I	Article: EHSR (1): 1.2.1	<table border="0" style="width: 100%;"> <tr> <td data-bbox="874 633 1225 678">EN/prEN: prEN 12622:2009</td> <td data-bbox="1225 633 1514 678">Other:</td> </tr> <tr> <td data-bbox="874 678 1225 723">Normative clause: 5.2</td> <td data-bbox="1225 678 1514 723">Other clause:</td> </tr> <tr> <td colspan="2" data-bbox="874 745 1514 790">CEN TC concerned: TC 143 WG1</td> </tr> </table>	EN/prEN: prEN 12622:2009	Other:	Normative clause: 5.2	Other clause:	CEN TC concerned: TC 143 WG1			
EN/prEN: prEN 12622:2009	Other:									
Normative clause: 5.2	Other clause:									
CEN TC concerned: TC 143 WG1										
Key words: Emergency stop										
Question: A press can be operated by a foot pedal. On this foot pedal an emergency stop is present. After using the emergency stop, it can be reset by pushing a button on the side of the pedal. Is this allowed or not?										
Answer: Yes, it is allowed to do so. The shrouding of a foot pedal may carry an emergency stop device (button). This device needs to be manually reset before the next starting signal can be initiated (see EN 60204-1). The foot pedal shall not be disconnectable.										
Adaptation procedure: FORMAL ADAPTATION IN CONFORMITY WITH DIRECTIVE 2006/42/EC										

(1) Essential health and safety requirement

Note: According to point 6.6 of the Guide of the implementation of directives based on the New Approach and the Global Approach, the notified bodies apply as general guidance this recommendation for use.

	CO-ORDINATION OF NOTIFIED BODIES Machinery-Directive 2006/42/EC + Amendment RECOMMENDATION FOR USE		CNB/M/03.073 Revision 05 Language : E
Date of first stage: 13/10/1997	To be approved by:		Approved on:
Origin: VG3 Presses for cold working metals	<input checked="" type="checkbox"/> Vertical Group..... <input checked="" type="checkbox"/> Horizontal Committee		30/09/2009 12/09/1996
	To be endorsed by: <input checked="" type="checkbox"/> Machinery Working Group.		Endorsed on: 08/06/1998
Question related to: Dir. 2006/42/EC	Article: Annex: I EHSR (1): 1.3.2	EN/prEN: 692:2005+A1:2009 Normative clause: 5.2.1.2 f) CEN TC concerned: TC 143	Other: Other clause:
Key words: Testing procedure for brake			
Question: Taking into account that the press has an overrun detection, what is the reason of the clause 5.2.1.2.f)? Note: take into account CNB/M/03.073/P/ERev 01 discussed during VG3 meeting on 04/03/96 and CNB/M/03.028/R/ERev 02.			
Solution: The requirement of the clause 5.2.1.2.f) shall prevent a blockage between the piston and the cylinder (or other linked mechanical parts) operating the brake. A blockage can lead to a continuously running of the press, so that the overrun detection will not stop the closing movement. This test should be carried out with maximum admissible clearance between the discs. (see CNB/M/03.008/R and CNB/M/03.028/R) <p style="text-align: center;">Adaptation procedure: FORMAL ADAPTATION IN CONFORMITY WITH DIRECTIVE 2006/42/EC</p>			

(1) Essential health and safety requirement

Note: According to point 6.6 of the Guide of the implementation of directives based on the New Approach and the Global Approach, the notified bodies apply as general guidance this recommendation for use.

	<p>CO-ORDINATION OF NOTIFIED BODIES MACHINERY DIRECTIVE 2006/42/EC + Amendment RECOMMENDATION FOR USE</p>	<p>CNB/M/03.078 Revision 08 Language: E</p>
<p>Date of first stage: 14/04/1997</p> <p>Origin: VG3 Presses for cold working metals</p>	<p>To be approved by:</p> <p><input checked="" type="checkbox"/> Vertical Group</p> <p><input checked="" type="checkbox"/> Horizontal Committee.....</p> <p>To be endorsed by:</p> <p><input checked="" type="checkbox"/> Machinery Working Group.</p>	<p>Approved on:</p> <p>30/09/2009</p> <p>21/11/2005</p> <p>Endorsed on:</p> <p>20/04/2006</p>
<p>Question related to: Dir. 2006/42/EC Article:</p> <p>Annex: I EHSR (1): 1.3.2, 1.5.13</p>	<p>EN/prEN: EN 692:2005+A1:2009 (1); EN 693:2001+A1:2009 (2) ; prEN 12622:2009 (3)</p> <p>Normative clause: 5.2.5.2 (1); 5.8.3 (2); 5.5.8 (3)</p> <p>CEN TC concerned: TC 143 WG1</p> <p>Other:</p> <p>Other clause:</p>	
<p>Key words: Protection, flexible piping</p>		
<p>Question:</p> <p>In clause 5.2.5.2 of EN 692 and 5.5.8 of prEN 12622 a general requirement is established. In clause 5.8.3 of EN 693 it is mentioned only in relation to the operators working position. How can sufficient protection be achieved around the press and at the top of the press if accessible?</p>		
<p>Solution:</p> <p>Well tried materials have to be selected for high pressure (> 5 MPa) flexible piping / hoses and their connectors at any location of the press where the flexible piping / hoses are not covered by other means. The hose shall have two steel-cord-layers as a minimum. The hose assembly shall be tear-proof (evidence possible by test-reports and by drawings). The ratio of the burst-pressure of the hose to the maximum pressure being possible in the considered circuit must be equal or higher than 3,5. No extraordinary environmental conditions (e.g. mechanical, thermal or chemical) are to be expected, unless the hose assembly is tested for these conditions. Flexible pipes shall be marked with the year of production. Instructions shall be included regarding the period and procedure of their replacement. In front of the normal working position/s flexible piping / hoses have to be installed inside the machine frame or have to be covered by additional means (e.g. by wider tubes) which are linked to fixed parts of the press. This is necessary to avoid whiplash of the pipe and high pressure fluid ejection in case of a rupture. When well tried materials are not selected additional means have to be provided to prevent whiplash by securing the hose to the frame of the press (e.g. chains / wires).</p> <p>Adaptation procedure: FORMAL ADAPTATION IN CONFORMITY WITH DIRECTIVE 2006/42/EC</p>		

(1) Essential health and safety requirement
Note: According to point 6.6 of the Guide of the implementation of directives based on the New Approach and the Global Approach, the notified bodies apply as general guidance this recommendation for use.

	CO-ORDINATION OF NOTIFIED BODIES MACHINERY DIRECTIVE 2006/42/EC + Amendment RECOMMENDATION FOR USE	CNB/M/03.088 Revision 09 Language: E
Date of first stage: 19/01/2001	To be approved by:	Approved on:
Origin: VG3 Presses for cold working metals	<input checked="" type="checkbox"/> Vertical Group <input checked="" type="checkbox"/> Horizontal Committee..... To be endorsed by: <input checked="" type="checkbox"/> Machinery Working Group...	30/09/2009 07/12/2000 Endorsed on: 04/01/2005
Question related to: Dir. 2006/42/EC Article: Annex: I EHSR (1):	EN/prEN: EN 692:2005+A1:2009 (1); EN 693:2001+A1:2009 (2) ; EN 13736:2003+A1:2009 (3) Normative clause: 5.3, 5.3.14 (1); 5.3.16 (2), 5.3.13 (3) CEN TC concerned: TC 143	Other: Other clause:
Key words: C - frame- press, safeguarding at the sides, single cycle		
Question: Using Two Hand Control Devices the sides of a C-frame-press are normally guarded. In which cases are side-guards not necessary?		
Solution: Where side guards are not practicable (e.g.: for ergonomic reasons, the press will be used with a table at the left and/or right side for unready and ready workpieces, the workpiece is larger than the table) they will not be required if the following five conditions are satisfied together: <ol style="list-style-type: none"> 1. The table width is less than 550 mm 2. There is only one THCD , fixed to the frame of the press, allowing the operator to supervise the front and lateral sides of the press 3. The depth of the table is less than 550 mm 4. Access from the rear shall be prevented 5. It has never to be expected that more than one operator is needed to do the work (intended use) 		
Adaptation procedure: FORMAL ADAPTATION IN CONFORMITY WITH DIRECTIVE 2006/42/EC		

(1) Essential health and safety requirement

Note: According to point 6.6 of the Guide of the implementation of directives based on the New Approach and the Global Approach, the notified bodies apply as general guidance this recommendation for use.

	CO-ORDINATION OF NOTIFIED BODIES MACHINERY DIRECTIVE 2006/42/EC + Amendment RECOMMENDATION FOR USE	CNB/M/03.095 Revision 05 Language: E
Date of first stage: 10/06/1996 Origin: VG3 Presses for cold working metals	To be approved by: <input checked="" type="checkbox"/> Vertical Group <input checked="" type="checkbox"/> Horizontal Committee To be endorsed by: <input checked="" type="checkbox"/> Machinery Working Group.	Approved on: 29/09/2009 19/09/1996 Endorsed on: 08/06/1998
Question related to: Dir. 2006/42/EC Article: Annex: I EHSR (1): 1.4	EN/prEN: EN 692:2005+A1:2009 Other: Normative clause: 5.3.15, annex Other clause: B CEN TC concerned: TC 143	
Key words: Guards, safety distance		
Question: Standard EN 999 provides parameters based on values for hand/arm and approach speed to determine minimum safety distances from specific sensing or actuating devices, so it doesn't take in consideration the early opening interlocking guards. On the other hand annex B of EN 692 only indicates that parameter C, in the general formula from EN 999, can be zero but it is not given the value of the parameter K. How to solve the problem of calculation of the safety distances for early opening interlocking guards?		
Solution: To achieve adequate protection, the following general formula may be used : $S = K(T-t') + C$ <p>t' is the necessary time to have the possibility to enter into the danger zone depending upon the design of the guard (the mass, the overlapping of the guard with the table, ...)</p> <p>K = 1,6 m/s.</p> <p>NOTE: C has to be considered if between the closing edges a gap remains</p> <p>Adaptation procedure: FORMAL ADAPTATION IN CONFORMITY WITH DIRECTIVE 2006/42/EC</p>		

(1) Essential health and safety requirement

Note : According to point 6.6 of the Guide of the implementation of directives based on the New Approach and the Global Approach, the notified bodies apply as general guidance this recommendation for use.



CO-ORDINATION OF NOTIFIED BODIES
MACHINERY DIRECTIVE 2006/42/EC + Amendment
RECOMMENDATION FOR USE

CNB/M/03.111
Revision 06
Language: E

Date of first stage: 24/09/2003	To be approved by:	Approved on:
Origin: VG3 Presses for cold working metals	<input checked="" type="checkbox"/> Vertical Group	29/09/2009
	<input checked="" type="checkbox"/> Horizontal Committee	11/12/2003
	To be endorsed by:	Endorsed on:
	<input checked="" type="checkbox"/> Machinery Working Group.	01/07/2004
Question related to: Dir. 2006/42/EC Article:	EN/prEN: EN 692:2005+A1:2009 Other:	
Annex: I EHSR (1): 1.3.8.2, 1.4.1, 1.4.3	EN 693:2001+A1:2009 Other clause:	
	Normative clause:	
	CEN TC concerned: TC 143	

Key words: Stopping time measurement / die cushion / ejector

Question:
Will a stopping time measurement be required for die cushions or ejectors?

Solution:
No, not in general, but the risk assessment shall take into consideration if the measurement is needed or not.
At the present time, the current standards do not require stopping time measurements for die cushions or ejectors.

Adaptation procedure: FORMAL ADAPTATION IN CONFORMITY WITH DIRECTIVE 2006/42/EC

(1) Essential health and safety requirement
Note: According to point 6.6 of the Guide of the implementation of directives based on the New Approach and the Global Approach, the notified bodies apply as general guidance this recommendation for use.

	CO-ORDINATION OF NOTIFIED BODIES Machinery Directive 2006/42/EC + Amendment RECOMMENDATION FOR USE		CNB/M/03.117 Revision 07 Language: E
Date of first stage: 24/09/2003	To be approved by:		Approved on:
Origin: VG3 Presses for the cold working of metals	<input checked="" type="checkbox"/> Vertical Group..... <input checked="" type="checkbox"/> Horizontal Committee To be endorsed by: <input checked="" type="checkbox"/> Machinery Working Group..		29/09/2009 26/11/2009 Endorsed on: 26/05/2010
Question related to: Dir. 2006/42/EC Annex: I	Article: 1.4.2.1 EHSR (1):	EN/prEN: EN 692:2005+A1:2009 Normative clause: 5.3.13 c) CEN TC concerned: TC 143	Other: Other clause:
Key words: AOPD / Additional guards			
Question: Will it be allowed that the additional guards preventing the standing between a light curtain and the danger zone are fastened by standard screws only?			
Recommended solution: No! Additional guards have to be permanently applied, e.g. by welding, one-way screws or by deforming the head of the screw to the press frame or interlocked with the press control system.			

(1) Essential Health and Safety Requirement

Note: According to point 6.6 of the Guide of the implementation of directives based on the New Approach and the Global Approach, the notified bodies apply as general guidance this recommendation for use.

	<p>CO-ORDINATION OF NOTIFIED BODIES MACHINERY DIRECTIVE 2006/42/EC + Amendment</p> <p>RECOMMENDATION FOR USE</p>	<p>CNB/M/03.124 Revision 07 Language: E</p>
Date of first stage: 25/08/1997	To be approved by:	Approved on:
Origin: VG3 Presses for cold working metals	<input checked="" type="checkbox"/> Vertical Group <input checked="" type="checkbox"/> Horizontal Committee.....	29/09/2009 21/11/2005
Question related to: Dir. 2006/42/EC Article: Annex: I EHSR (1): 1.4.1	EN/prEN: EN 12622:2001 Normative clause: 5.3.22 CEN TC concerned: TC 143/WG1	Other: Other clause:
Key words: press-brakes / tandem assembly		
Question: Which requirements have to be achieved in the design if a tandem assembly of press brakes is used singly?		
Solution: When a tandem assembly of two press brakes is used singly, the singly used parts of the assembly have to fulfil the safety requirements which apply to single machines according to EN 12622, especially: a) The two machine control systems have to function separately. b) Between both press brakes, a guard and its position have to be activated (interlocking guard). c) The extension of the guard towards the operator measured from the bending line shall be at least 230 mm in accordance to the requirement for single press brakes as illustrated in the harmonised standard EN 12622, Annex F. d) This operational mode has to be selected e.g. by a separated selector switch or by separated positions of the existing mode selector.		
<p>Adaptation procedure: FORMAL ADAPTATION IN CONFORMITY WITH DIRECTIVE 2006/42/EC</p>		

(1) Essential health and safety requirement

Note: According to point 6.6 of the Guide of the implementation of directives based on the New Approach and the Global Approach, the notified bodies apply as general guidance this recommendation for use.

	CO-ORDINATION OF NOTIFIED BODIES MACHINERY DIRECTIVE 2006/42/EC + Amendment RECOMMENDATION FOR USE		CNB/M/03.128 Revision 08 Language: E
Date of first stage: 28/09/1998	To be approved by: <input checked="" type="checkbox"/> Vertical Group <input checked="" type="checkbox"/> Horizontal Committee..... To be endorsed by: <input checked="" type="checkbox"/> Machinery Working Group		Approved on: 29/09/2009 09/06/2005 Endorsed on: 29/10/2005
Origin: VG3 Presses for cold working metals			
Question related to: Dir. 2006/42/EC	Article:	EN/prEN: EN 693:2001 EN 12622:2001	Other: EN 954-1:1996
Annex: I	EHSR (1): 1.2.1	Normative clause:	Other clause:
Key words: Overlapping, Monitoring Valves		CEN TC concerned: TC 143 WG 1	
Question :			
<ol style="list-style-type: none"> 1.) Which positive overlapping of a (safety related) directional valve can be considered as proper? 2.) Have measures to be taken to test the position monitoring of valves? 3.) Is a binary output of the position monitoring of a proportional valve required or is an analogous output also acceptable? 			
Answer :			
<ol style="list-style-type: none"> 1.) The positive overlapping of a directional valve (e.g. restraint valve) shall ensure that the closing speed cannot exceed 1 mm/s as long as the directional valve is in resting position. The positive overlapping of a proportional valve should be bigger or equal than 0,35 mm. The positive overlapping of other directional valves should be equal or bigger than 0,5 mm. Manufacturing tolerances of the parts of the directional valve have to be taken into account. 2.) Measures to check the position monitoring of valves are not required. (The electronics of a position monitoring must conform to – at least- category B of EN 954-1.) The Change of signal must be monitored. 3.) An analogue output of the position monitoring of a proportional valve is acceptable. (The electronics of the position monitoring of a valve must conform to category B of EN 954-1.) 			
Remark: If the protection for the operator is raised during the closing stroke all safety related valves must be separated from the electrical energy supply by opening contacts (except the gap between the tools does not exceed 6 mm).			
Note: Good experience have been made with a positive overlapping of a proportional valve equal or more than 0,35 mm and of a directional valve equal or more than 0,5 mm			
Adaptation procedure: FORMAL ADAPTATION IN CONFORMITY WITH DIRECTIVE 2006/42/EC			

(1) Essential health and safety requirement

Note: According to point 6.6 of the Guide of the implementation of directives based on the New Approach and the Global Approach, the notified bodies apply as general guidance this recommendation for use.

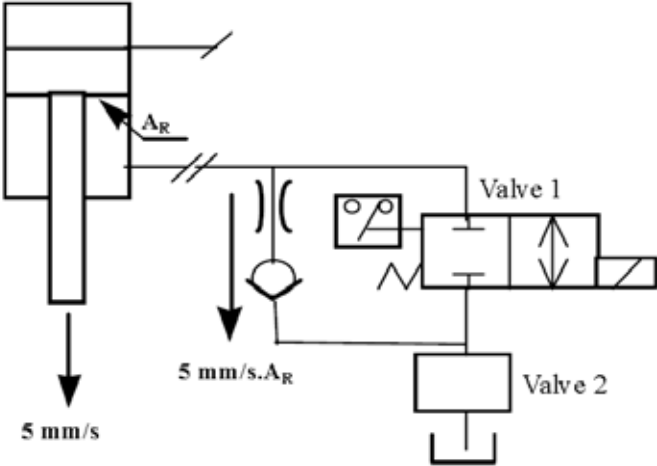
	CO-ORDINATION OF NOTIFIED BODIES MACHINERY DIRECTIVE 2006/42/EC + Amendment RECOMMENDATION FOR USE	CNB/M/03.141 Revision 04 Language: E
Date of first stage: 24/05/2000	To be approved by:	Approved on:
Origin: VG3 Presses for cold working metals	<input checked="" type="checkbox"/> Vertical Group..... <input checked="" type="checkbox"/> Horizontal Committee To be endorsed by: <input checked="" type="checkbox"/> Machinery Working Group.	29/09/2009 02/06/1999 Endorsed on: 03/03/2000
Question related to: Dir. 2006/42/EC Article: Annex: I EHSR (1): 1.2.1	EN/prEN: EN 693:2001+A1:2009 Normative clause: 5.4 CEN TC concerned: TC 143	Other: Other clause:
Key words: Bypassing monitored restraint valves		
Question: Under which conditions bypassing a restraint valve is allowed?		
Solution: 1) The volume flow in the bypass shall be restricted to the value of $5 \text{ mm/s} \times A_R$ (ring area) of the cylinder, e.g. by a bleed (orifice plate) 2) The check valve in the bypass can fail without any detection (see figure) 3) If the second restraint valve fails also, the speed (leakage speed) of the beam/slide/ram shall not increase more than 5 mm/s (check valve failed already without detection) Note: The max. weight of slide/ram/beam with tools has to be taken into consideration		
		
Adaptation procedure: FORMAL ADAPTATION IN CONFORMITY WITH DIRECTIVE 2006/42/EC		

(1) Essential health and safety requirement

Note: According to point 6.6 of the Guide of the implementation of directives based on the New Approach and the Global Approach, the notified bodies apply as general guidance this recommendation for use.

	CO-ORDINATION OF NOTIFIED BODIES Machinery Directive 2006/42/EC + Amendment RECOMMENDATION FOR USE	CNB/M/03.143 Revision 09 Language: E
Date of first stage: 24/05/2000	To be approved by:	Approved on:
Origin: VG3 Presses for cold working metals	<input checked="" type="checkbox"/> Vertical Group	12/10/2010
	<input checked="" type="checkbox"/> Horizontal Committee	14/12/2010
Question related to: Directive 2006/42/EC Article: Annex: I ESR (1): 1.2.1	EN/prEN: EN 692:2005 +A1:2009	Other:
	CEN TC concerned: TC 143	
Key words: Spindle / Screw presses - block / shoe brakes		
Question: Which requirements shall the block / shoe brake of a spindle / screw press meet?		
Solution: 1) The brake shall be released by admission of energy. 2) Multiple brake block / shoe assemblies shall be used. 3) The brake linings should be glued or sintered on to the brake shoe. Mechanical fixing (eg rivets) is not adequate 4) The brake shall function even if 50% of brake blocks / shoes have failed (braking torque > driving torque for starting). 5) The failure of the brake block / shoe assembly shall be detected. Failure of the detecting system must be detected by plausibility check 6) The solidity of the block/shoe brake shall be given proof of the practical testing 7) The break shall be designed in such a way that any moisture, dust or lubricating oil, can't influence the required function. Remark : Not all block/shoe brakes are shown in the enclosed drawings are designed in such a way that the same level of safety as laid down in clause 5.2.1.7 of EN 692: 2009 is achieved		

(1) Essential safety requirement

Note: According to point 6.6 of the Guide of the implementation of directives based on the New Approach and the Global Approach, the notified bodies apply as general guidance this recommendation for use.

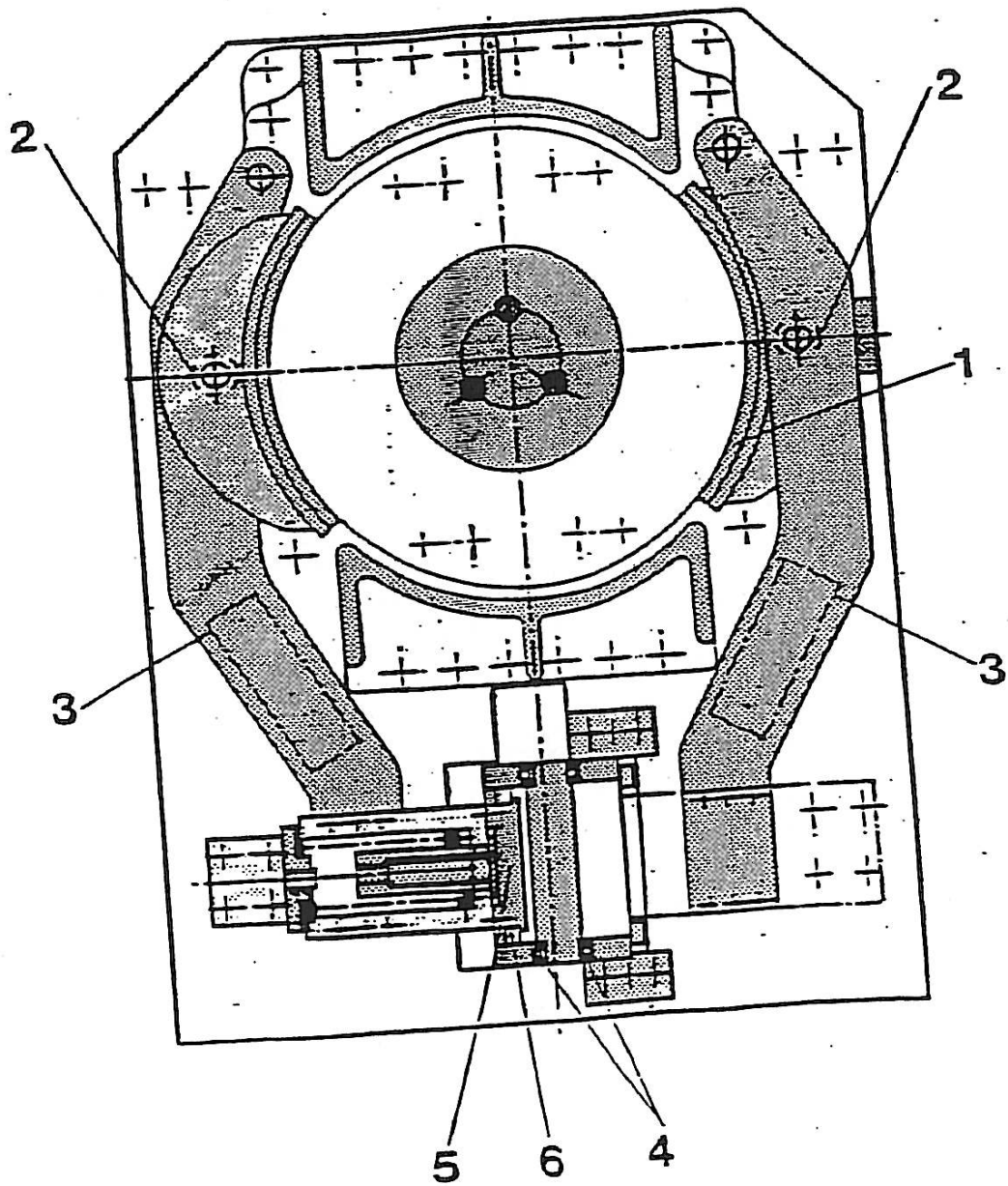

1. Brake lining
2. Brake shoe
3. Brake lever/calliper
4. Sliding gap / wear indication
5. Cylinder piston
6. Cylinder housing

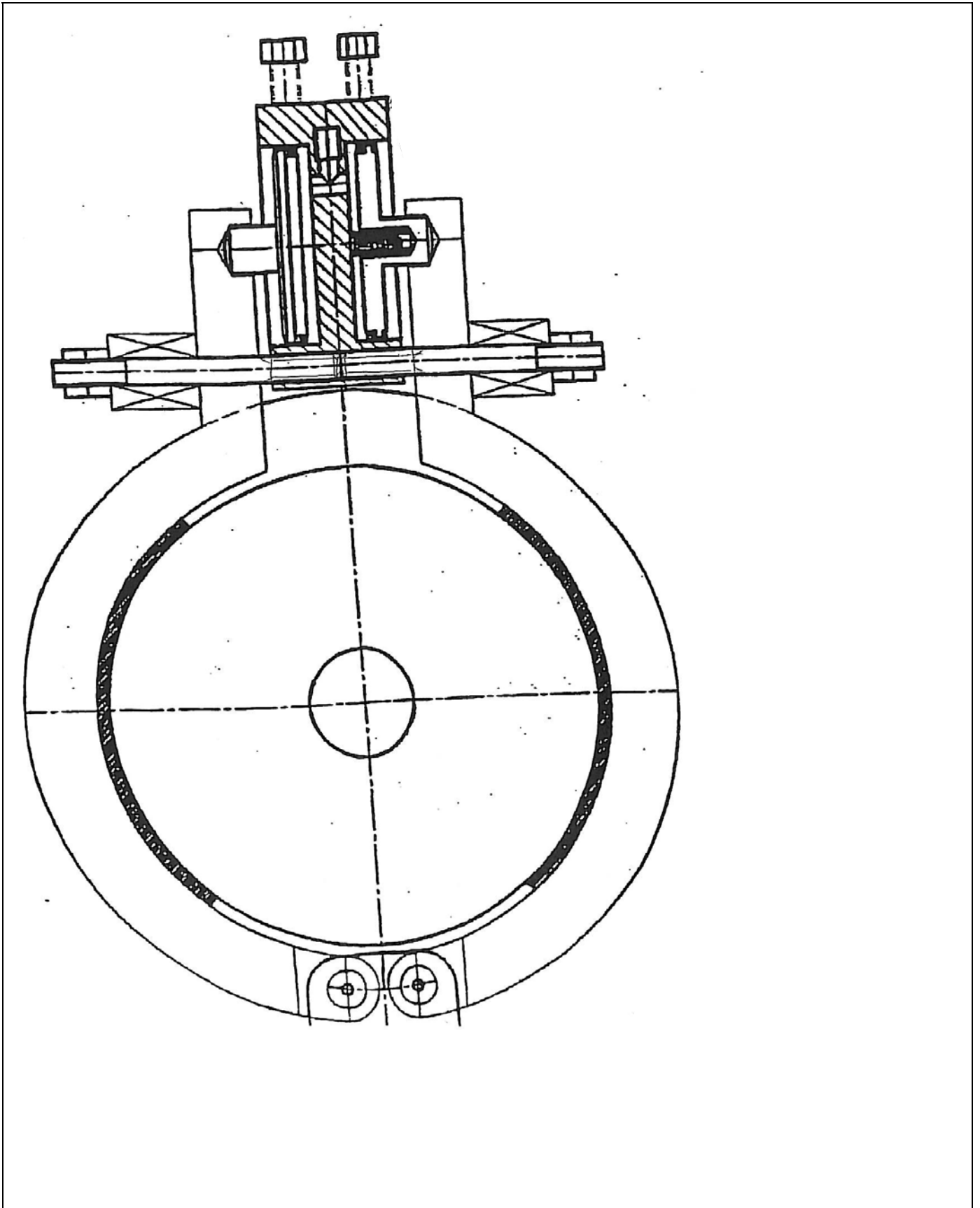

	CO-ORDINATION OF NOTIFIED BODIES Machinery Directive 2006/42/EC + Amendment RECOMMENDATION FOR USE		CNB/M/03.154 Revision 07 Language: E
Date of first stage: 25/03/2002	To be approved by:		Approved on:
Origin: VG3 Presses for cold working metals	<input checked="" type="checkbox"/> Vertical Group	30/09/2009	
	<input checked="" type="checkbox"/> Horizontal Committee.....	24/10/2002	
	To be endorsed by:		Endorsed on:
	<input checked="" type="checkbox"/> Machinery Working Group.		02/03/2004
Question related to: Dir. 2006/42/EC	Article:	EN/prEN: EN 693:2001+A1:2009	Other:
Annex: I	EHSR (1): 1.2.1, 1.6.1, 1.6.4	Normative clause: 5.2.1, 5.2.2	Other clause:
CEN TC concerned: TC 143			
Key words: Hydraulic presses, Mechanical restraint device, Production and Maintenance			
Question: Under which conditions is it possible to use the device shown on page 2 as a mechanical restraint device?			
Solution: The restraint device shown on page 2 cannot be used as mechanical restraint devices in the sense of 5.2.1.1, 1 st indent, because they act by friction alone. It can be used in combination with a hydraulic restraint device in the sense of clause 5.2.1.1, 3 rd indent, if the function of both restraint devices are monitored (see 5.2.1.4) in such a way that if the hydraulic restraint device fails the possibility to introduce pressure in the upper part is always avoided. The restraint device shown on page 2 can be used alone also as a restraint device in the sense of cl. 5.2.2 of EN 693.			
Adaptation procedure: FORMAL ADAPTATION IN CONFORMITY WITH DIRECTIVE 2006/42/EC			

(1) Essential health and safety requirement

Note: According to point 6.6 of the Guide of the implementation of directives based on the New Approach and the Global Approach, the notified bodies apply as general guidance this recommendation for use

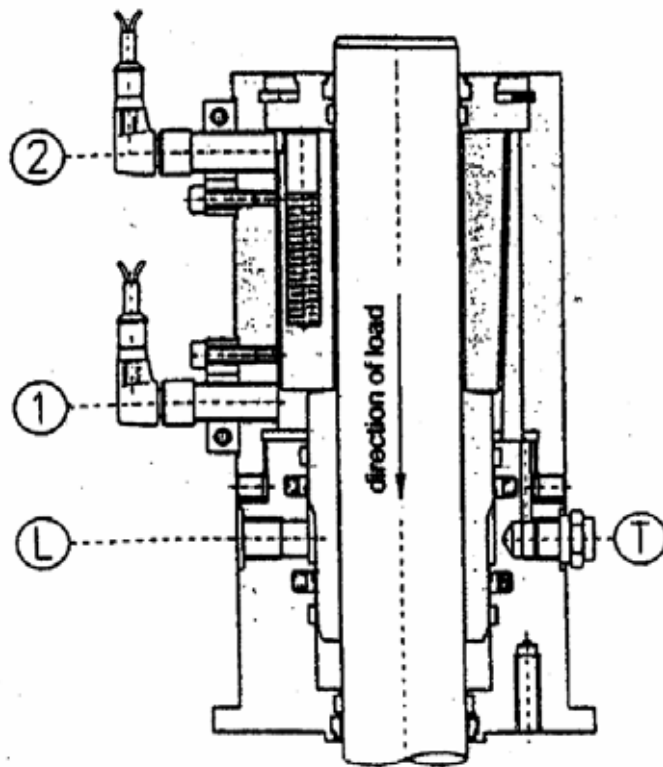



Figure of KR-Type

Legend

- | | | | |
|---------------------|---|---------------------------------------|-------------------|
| Sensors of position | { | 1 | Load secured |
| | | 2 | Clamping released |
| L inlet port | { | to introduce/ evacuate pressure | |
| T outlet port | | with the help of one auxiliary valve. | |

Figure 2

	<p>CO-ORDINATION OF NOTIFIED BODIES</p> <p>Machinery Directive 2006/42/EC + Amendment</p> <p>RECOMMENDATION FOR USE</p>	<p>CNB/M/03.157</p> <p>Revision 05</p> <p>Language: E</p>
Date of first stage: 17/05/2000	To be approved by:	
Origin: VG3 Presses for cold working metals	<input checked="" type="checkbox"/> Vertical Group <input checked="" type="checkbox"/> Horizontal Committee.....	<p>Approved on:</p> <p>29/09/2009</p> <p>09/06/2005</p>
<p>Question related to: Dir. 2006/42/EC Article: 1.5.14</p> <p>Annex: I EHSR (1):</p>		<p>To be endorsed by:</p> <input checked="" type="checkbox"/> Machinery Working Group...
Key words: Press-Brake, Hydraulic Press, Release of trapped persons		<p>EN/prEN: EN 12622:2001 (1) Other: EN 693:2001 +A1:2009</p> <p>Pr EN 12622 :2009 (2) Other clause: 5.3.20</p> <p>Normative clause: 5.3.25 (1) 5.4.6 (2)</p> <p>CEN TC concerned: TC 143 WG 1</p>
<p>Question:</p> <p>Down stroking Press:</p> <p>What means shall be required to release trapped person when:</p> <ol style="list-style-type: none"> 1. an emergency stop is actuated or 2. a foot pedal - used as a hold to run control device - is actuated in the third position? 		
<p>Answer :</p> <p>An opening control device of the beam must remain operative, even if the emergency stop and/or the third position of a foot pedal used as a hold to run control device is still actuated. It shall be immediately operative without the need to reset any part of the control system.</p> <p>The emergency stop and/or the third position of the foot pedal shall not stop the pump!</p> <p>If the press brake includes an opening control device used for normal operations, it must be designed to be used also for this safety function.</p> <p>Adaptation procedure: FORMAL ADAPTATION IN CONFORMITY WITH DIRECTIVE 2006/42/EC</p>		

(1) Essential health and safety requirement

Note: According to point 6.6 of the Guide of the implementation of directives based on the New Approach and the Global Approach, the notified bodies apply as general guidance this recommendation for use.

	CO-ORDINATION OF NOTIFIED BODIES Machinery Directive 2006/42/EC + Amendment RECOMMENDATION FOR USE	CNB/M/03.159 Revision 06 Language: E
Date of first stage: 25/03/2002	To be approved by:	Approved on:
Origin: VG3 Presses for cold working metals	<input checked="" type="checkbox"/> Vertical Group <input checked="" type="checkbox"/> Horizontal Committee.....	29/09/2009 24/10/2002
Question related to: Dir. 2006/42/EC Article: Annex: I EHSR (1): 1.2	EN/prEN: EN 693:2000, EN 12622:2001 Normative clause: CEN TC concerned: TC 143	Other: EN 13846-1:2008, EN 60204-1:2006 Other clause:
Key word: Valve monitoring, PES		
Question: Can, in case of control systems in accordance with category 4 of EN 954-1, a standard PES (EN 954:1996 category B) be used for valve monitoring?		
Solution: Yes, a standard PES (Programmable Electronic System) may be used for valve monitoring (considered as a passive safety function), if the following conditions are fulfilled: Functional requirements: - The automatic monitoring shall at discovered failure prevent a new closing stroke of the press. - The change of the monitoring signal shall be checked automatically during each cycle of the press. Wiring requirements to avoid common mode failures: - Each position switch shall be connected to its own input module or - If a single input module is used the signals of antivalent logic from different position switches shall be inputted as well. Software verification: - Following safety related principles, it is necessary to verify the software and to give instructions on periodic maintenance. Modification protection of software: - The manufacturer shall write a warning in the software close to the part of programme concerning the monitoring that this part must not be deactivated or modified for safety reasons. Other requirements: - The information from the PES used for monitoring the valves shall be periodically (once per cycle) monitored and tested. Protection of programme sequence: - The programme shall be monitored by e.g. an internal watchdog. Note 1: The valve monitoring acts as a passive monitoring device, that is, it does not itself initiate any hazardous movements but permits or disables a hazardous movement of the machine if a fault was detected. Adaptation procedure: FORMAL ADAPTATION IN CONFORMITY WITH DIRECTIVE 2006/42/EC		

(1) Essential health and safety requirement

Note: According to point 6.6 of the Guide of the implementation of directives based on the New Approach and the Global Approach, the (notified bodies apply as general guidance this recommendation for use.

	CO-ORDINATION OF NOTIFIED BODIES MACHINERY DIRECTIVE 98/37/EC AMENDED RECOMMENDATION FOR USE		CNB/M/03.162 Revision 09 Language : E
Date of first stage : 09/10/2001	To be approved by :		Approved on :
Origin : VG3 Presses for the cold working of metals	<input checked="" type="checkbox"/> Vertical Group 20/03/2007 <input checked="" type="checkbox"/> Horizontal Committee		20/03/2007
	To be endorsed by : <input checked="" type="checkbox"/> Working Group 98/37/EC Machinery 21/04/2015		
Question related to : Dir. 98/37/EC Annex :	Article : EHSR (1) : 1.2.5, 1.4.3	prEN : 12622 : 2003 Normative clause : 5.2.5.5.3 CEN TC concerned : TC 143	Other : Other clause :
Key words : AOPD - Press Brakes			
Question : 1. Can an ESPE using AOPD in the form of laser beams for which the protective zone is close to the punch tip, fixed to the beam of a press brake be used as an alternative to the safeguarding measures described in 5.3.2 of EN 12622:2001? 2. What are the minimum requirements?			
Answer : See pages 2 and 3.			

(1) Essential health and safety requirement

Note : According to point 6.6 of the Guide of the implementation of directives based on the New Approach and the Global Approach, the notified bodies apply as general guidance this recommendation for use.

1. Yes, it can, for example, when the positioning of the protective zone is as described below:

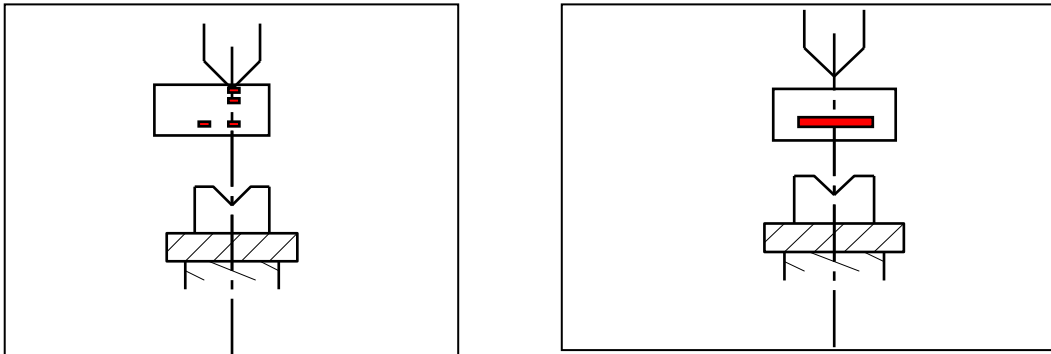

2. The minimum requirements are:
- 2.1 This is a safety component according to Annex IV of the Machinery Directive. It shall conform to type 4 in accordance with 4.2.2.5 of EN 61496-1:1997 (and be designed and constructed according to prEN 61496-2:1997 or equivalent). The intended use specific to press brakes must have been certified by a notified body.
- 2.2 The maximum stopping distance of the press brake shall not exceed the values given by the manufacturer of the protective device.
- 2.2 a It must be monitored at least for each first stroke after the press brake has been switched on. If this distance is exceeded, the press must be automatically stopped. This device must be at least category 3 of EN 954-1:1996 and monitored at least for each first stroke after the press brake has been switched on.
- 2.2 b During the construction of the press brake, the maximum stopping distance of the beam for each model and size of press brake has to be measured separately for each possible operating channel at least 10 times. The highest measured value or the mean plus 3 times the standard deviation shall be taken for the comparison. To measure this stopping distance, the conditions described in Annex A, paragraph A.4 of EN 12622:2001 shall be taken into account.
- 2.3 Access from the sides of the danger zone shall be prevented as described in clause 5.3.22 of EN 12622:2001.
- 2.4 Access from the rear of the danger zone shall be prevented as described in clause 5.3.23 of EN 12622:2001.
- 2.5 It must not be used for cycle initiation.
- 2.6 Muting
It shall be achieved at least as described in clause 5.3.15 of EN 12622:2001.
- 2.7 Blanking (Ref. prEN 12622 / CEN/TC143/WG1 Doc N 581)
For a special mode of operation, e.g. box bending, the following measures shall be taken to blank only the protection zone in front of the bending line with the protective field in the bending plane still active:
- Means of selection shall be provided for this special mode of operation,
 - A suitable indicator, active when the protection zone is blanked, shall be provided,
 - Blanking of this protection zone during the closing stroke is possible if the closing speed is reduced to 10 mm/s or less, in conjunction with a hold-to-run control device,
 - This special mode of operation shall be automatically de-activated
 - at each power on of the machine,
 - after a mode selection change,
 - after a change of program of the numerical control,

- within 8 hours running time,
- Blanking of this protection zone is also possible when the stroke is required in fast speed (more than 10 mm/s), given that the blanking function may be activated before each bending stroke by the control system (e.g. by information coming from the numerical control to determine the sequence of blanked and non blanked strokes). For each of the strokes requiring the blanking, the operator shall have a separate confirming action (e.g. push button or extra depression of foot pedal) before the blanking is permitted.

2.8 Positioning of the beams

- Clear indications must be included in the instruction handbook of the press brake, including the kind of tools which may be used (e.g. shape of the tools).
- Only the height of the beams may be adjusted by the user.

2.9 Additional guards preventing from the risks relating to the moving parts (between the safety device and the fixed parts of the press brake).

Adaptation of such a system must not create new hazards in relation to the fixed mechanical parts of the press brake.

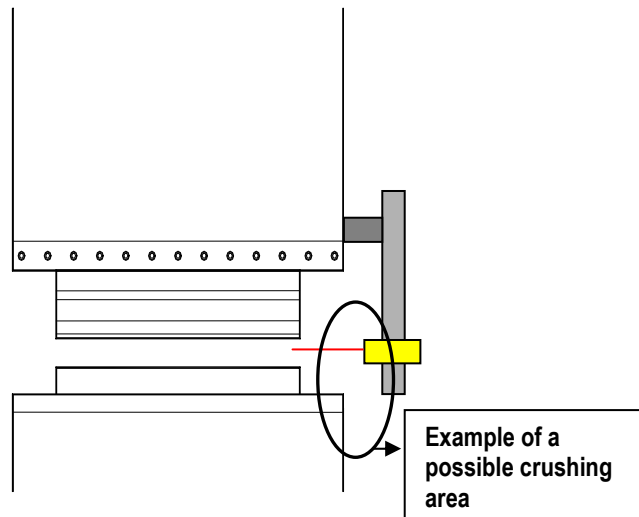

- 2.10 It shall be fixed to the press brake so that the changing of the tools (especially the punch) can be possible without removing the device from the press brake.
- 2.11 Hydraulic and electrical control systems shall be designed as described in clauses 5.2.3, 5.2.4 and 5.4 of EN 12622:2001.

	CO-ORDINATION OF NOTIFIED BODIES Machinery Directive 2006/42/EC + Amendment RECOMMENDATION FOR USE	CNB/M/03.164 Revision 06 Language: E
Date of first stage: 23/09/2002	To be approved by:	Approved on:
Origin: VG3 Presses for cold working metals	<input checked="" type="checkbox"/> Vertical Group <input checked="" type="checkbox"/> Horizontal Committee.....	29/09/2009 16/06/2003
Question related to: Dir. 2006/42/EC Article: Annex: I EHSR (1): 1.2.5	EN/prEN: EN 12622:2001 Normative clause: 5.4.3 CEN TC concerned: TC 143	Other: prEN 12622:2009 Other clause: 5.2.5.11
Key words: Press Brakes - Mode selection		
<p>Question:</p> <p>In some cases, press brakes are arranged and programmed to carry out in one cycle successively several operations on the same product.</p> <p>In such cases, the machine can for example have two control stations, that are activated by the program at the right moment and used by the same operator. Under which conditions can we accept such kind of "mode selection" carried out solely by the (normal) programmable control?</p> <p>A variant of the described situation is e.g. the case where at certain moments a single operator is working with the machine, while at other moments there are two operators. Here also there are technical solutions defining through software the active station(s).</p>		
<p>Solution:</p> <p>A normal programmable system by itself is not able to do the selection of the number of operators. The selection of the numbers of operators shall be necessarily hardwired or monitored by a safety PLC. Two cases could be considered:</p> <p>A) In case of one operator using different work stations: Yes, when an AOPD (in the form of light curtain or multi-beam laser system) is active only during the approach; when it is muted, the press brake shall work with hold-to-run control in conjunction with slow speed. The activation of a work station shall be indicated by visual means (e.g. lamp). This visual signal shall be periodically monitored (e.g. by pressing a push button). In the case of a fault in the control system, it shall not be possible to have several work stations active simultaneously.</p> <p>B) In case of several operators using each a different working station: No, in general it is not permitted to work in this way (see clauses. 5.3.19 and 5.4.3.3 of EN 12622:2001); however, when an AOPD (in the form of light curtain) is active during the whole stroke and without interruption of the detection field, it is permissible to work with only one starting device.</p> <p>Adaptation procedure: FORMAL ADAPTATION IN CONFORMITY WITH DIRECTIVE 2006/42/EC</p>		

(1) Essential health and safety requirement

Note: According to point 6.6 of the Guide of the implementation of directives based on the New Approach and the Global Approach, the notified bodies apply as general guidance this recommendation for use.

	CO-ORDINATION OF NOTIFIED BODIES Machinery Directive 2006/42/EC + Amendment RECOMMENDATION FOR USE		CNB/M/03.165 Revision 05 Language: E
Date of first stage: 23/09/2002	To be approved by:		Approved on:
Origin: VG3 Presses for cold working metals	<input checked="" type="checkbox"/> Vertical Group	29/09/2009	
	<input checked="" type="checkbox"/> Horizontal Committee.....	16/06/2003	
	To be endorsed by:		Endorsed on:
	<input checked="" type="checkbox"/> Machinery Working Group.		17/12/2003
Question related to: Dir. 2006/42/EC	Article:	EN/prEN: prEN 12622:2009	Other:
Annex: I	EHSR (1): 1.3.7, 1.4.3	Normative clause: 5.1.1.4.1 f)	Other clause:
CEN TC concerned: TC 143			
Key words: Press Brakes, Light curtains-Blanking			
<p>Question:</p> <p>On press brakes fitted with light curtains it is often necessary to blank out partial areas (see figure 1) of the protection field only for making invisible the work-piece supports.</p> <p>Is it in this case obligatory to correct the safety distance between the protection field and the danger spot?</p>			
<p>Answer:</p> <p>It is not obligatory to correct the safety distance (see figure 2) when blanking if the following conditions are fulfilled:</p> <ul style="list-style-type: none"> - The resolution of the light curtain at the blanking point shall be ≤ 30 mm; means shall be provided to prevent the user from reprogramming the safety interface; - The resolution in the rest of the area shall be 14 mm; - The safety distance shall be calculated as described in Annex A of EN 12622:2001, using a resolution of 14 mm; - The safety distance shall be ≥ 150 mm; - It shall not be permitted to initiate cycles using the light curtain; - There shall not be more blanking areas than necessary for making invisible the sheet supports; - The manufacturer has to incorporate a warning into the operator's instruction manual to make him aware of the different resolutions in the two areas. <p>NOTE: When changing the height of the die, it is necessary to change the position of the blanking area to establish a clear correlation between the blanking area and the position of the sheet supports.</p> <p>Figures see page 2.</p>			
<p>Adaptation procedure: FORMAL ADAPTATION IN CONFORMITY WITH DIRECTIVE 2006/42/EC</p> <p>(1) Essential health and safety requirement</p> <p>Note: According to point 6.6 of the Guide of the implementation of directives based on the New Approach and the Global Approach, the notified bodies apply as general guidance this recommendation for use.</p>			

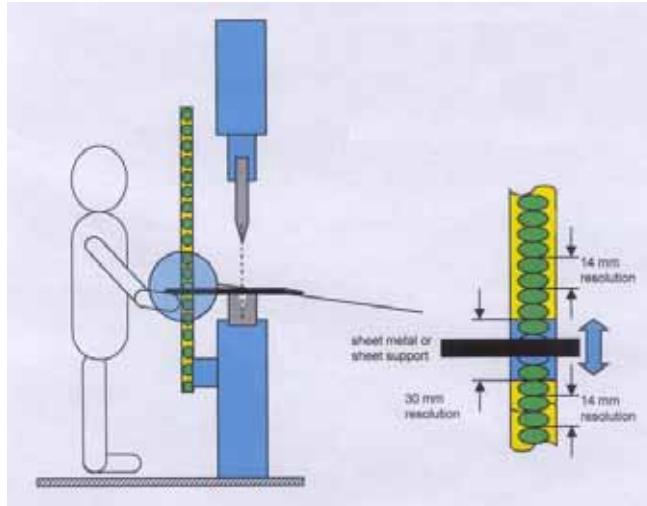

Figure 1

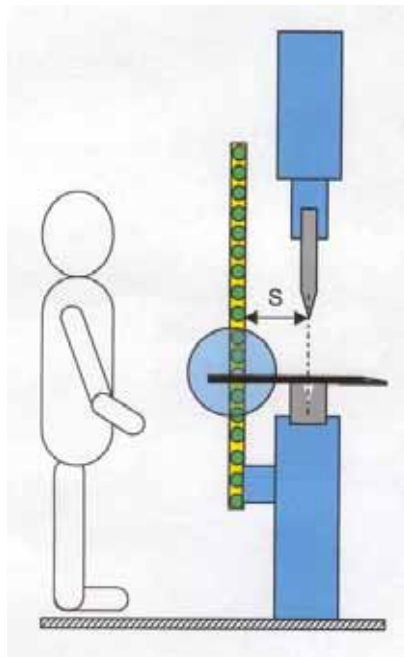



Figure 2

	CO-ORDINATION OF NOTIFIED BODIES Machinery Directive 2006/42/EC + Amendment RECOMMENDATION FOR USE		CNB/M/03.166 Revision 06 Language: E
Date of first stage: 25/03/2003	To be approved by:		Approved on:
Origin: VG3 Presses for cold working metals	<input checked="" type="checkbox"/> Vertical Group	29/09/2009	
	<input checked="" type="checkbox"/> Horizontal Committee.....	16/06/2003	
	To be endorsed by:		Endorsed on:
	<input checked="" type="checkbox"/> Machinery Working Group.		17/12/2003
Question related to: Dir. 2006/42/EC Annex: I	Article: EHSR (1): 1.3.7, 1.4.1, 1.4.3	EN/prEN: prEN 12622:2009 Normative clause: 5.1.1.5 CEN TC concerned: TC 143	Other: Other clause:
Key words: Press Brakes, AOPD			
Question: Can an ESPE using AOPD in the form of a mono-beam or multi-beam laser for which the protection zone is close to the die, fixed to the table of a downstroking press brake, be used as an alternative to the safeguarding measures described in 5.3.2 of EN 12622:2001?			
Solution: No, the laser devices (mono-beam or multi-beam) fixed to prisms in a horizontal position and with a protected zone limited to some millimeters adjacent to the bending plane are considered no longer state of the art as it is difficult to fulfill the essential requirements of the Machinery Directive.			
Adaptation procedure: FORMAL ADAPTATION IN CONFORMITY WITH DIRECTIVE 2006/42/EC			

(1) Essential health and safety requirement

Note: According to point 6.6 of the Guide of the implementation of directives based on the New Approach and the Global Approach, the notified bodies apply as general guidance this recommendation for use.

	CO-ORDINATION OF NOTIFIED BODIES Machinery Directive 2006/42/EC + Amendment RECOMMENDATION FOR USE	CNB/M/03.170 Revision 05 Language: E
Date of first stage: 25/03/2003	To be approved by:	Approved on:
Origin: VG3 Presses for cold working metals	<input checked="" type="checkbox"/> Vertical Group..... <input checked="" type="checkbox"/> Horizontal Committee	29/09/2009 16/06/2003
Question related to: Dir. 2006/42/EC Article: Annex: I EHSR (1): 1.2	EN/prEN: EN 693:2001+A1:2009 Normative clause: CEN TC concerned: TC 143	Other: Other clause:
Key words: Hydraulic Presses with "Low force approach" - Controls		
Question: Are redundant controls and monitoring required for presses with "low force approach" (equal or less than 150 N or 50 N per cm ²) and reduced speed (2 m/min) in conjunction with hold-to-run control?		
Solution: Yes, redundant controls and monitoring are required unless the closing speed does not exceed 10 mm/s in conjunction with hold-to-run control as the only mode of operation. NOTE: If VG 3 receives additional information about a specific solution which gives sufficient guarantee that the low force approach function is not lost easily and about the means to change to full force, this question could be reconsidered.		
Adaptation procedure: FORMAL ADAPTATION IN CONFORMITY WITH DIRECTIVE 2006/42/EC		

(1) Essential health and safety requirement

Note: According to point 6.6 of the Guide of the implementation of directives based on the New Approach and the Global Approach, the notified bodies apply as general guidance this recommendation for use.

	<p>CO-ORDINATION OF NOTIFIED BODIES Machinery Directive 2006/42/EC + Amendment</p> <p>RECOMMENDATION FOR USE</p>	<p>CNB/M/03.172 Revision 04 Language: E</p>
Date of first stage: 25/09/2002	To be approved by:	Approved on:
Origin: VG3 Presses for cold working metals	<input checked="" type="checkbox"/> Vertical Group..... <input checked="" type="checkbox"/> Horizontal Committee	<p>29/09/2009 16/06/2003</p> <p style="text-align: center;">To be endorsed by:</p> <input checked="" type="checkbox"/> Machinery Working Group...
<p>Question related to: Dir. 2006/42/EC Article: Annex: I EHSR (1): 1.2.1</p>	<p>EN/prEN: EN 692:2005+A1:2009 Normative clauses: 5.2.1.3, 5.2.3.11 CEN TC concerned: TC 143</p>	<p>Other: Other clause:</p>
Key words: Safety valve, separated clutch and brake		
<p>Question: In a mechanical press with pneumatic clutch and brake separated, is it necessary to use two separate safety valves, one for the control of the clutch and another for the control of the brake or is it possible to use only one safety valve for the control of both?</p>		
<p>Answer: For a mechanical press: 1. To initiate a stroke, it is necessary first to release the brake and then to control the clutch. 2. To stop a movement, it is necessary to release the clutch and then to control the brake. In order to prevent unintended gravity fall, a short time is required for synchronisation particularly in such cases where two valves are used. This can be achieved either by one or two double-bodied safety valves. The manufacturer of the press shall provide means (e.g. bleeds) to avoid overlapping between clutch and brake and, relating to residual pressure, shall take care of the positioning of the valves. This must be achieved according to the technical documentation of the clutch, the brake and the valves. The technical file must contain a clear description of that means, if necessary, with a calculation.</p> <p>Adaptation procedure: FORMAL ADAPTATION IN CONFORMITY WITH DIRECTIVE 2006/42/EC</p>		

(1) Essential health and safety requirement

Note: According to point 6.6 of the Guide of the implementation of directives based on the New Approach and the Global Approach, the notified bodies apply as general guidance this recommendation for use.

	CO-ORDINATION OF NOTIFIED BODIES Machinery Directive 2006/42/EC + Amendment RECOMMENDATION FOR USE	CNB/M/03.177 Revision 04 Language: E
Date of first stage: 07/06/2004	To be approved by:	Approved on:
Origin: VG3 Presses for cold working metals	<input checked="" type="checkbox"/> Vertical Group <input checked="" type="checkbox"/> Horizontal Committee.....	30/09/2009 09/12/2004 To be endorsed by: <input checked="" type="checkbox"/> Machinery Working Group.
Question related to: Dir. 2006/42/EC Article: Annex: I EHSR (1): 1.2.3	EN/prEN: prEN12622:2003/10 Normative clause: 5.2.5.5.3 n) CEN TC concerned: TC 143	Other: Other clause:
Key words: Hydraulic press brake - AOPD moving with the beam, box bending, mode confirmation		
<p>Question:</p> <p>5.2.5.5.3 Paragraph n) requires that any blanking shall require deliberate confirmation by the operator. Further, when this blanking is activated it shall need automatic deactivation after each cycle before or at next Top Dead Centre.</p> <p>Is it acceptable that this confirmation especially for box bend mode is derived from other means than the operator? Some machines do derive this confirmation from their CNC and therefore the confirmation is once programmed, from then on it is automatically. Is this an acceptable level of safety?</p> <p>Note:</p> <p>The question above is dealing with a programmable box bending sequence (predetermined number of strokes where some of these strokes, at least one, are carried out with a blanked front beam) in contradiction with paragraph e of 5.2.5.5.3 of prEN 12622:2003/10 where box bending mode is defined as a single stroke with blanked front beam.</p>		
<p>Solution:</p> <p>No, this is not acceptable. The new draft standard needs to clarify points e) and n) of clause 5.2.5.5.3. The aim of the requirement is to make the operator aware that the normal level of safety is only partially available.</p> <p>The box bending mode has to be selected by key selector switch or by appropriate positive means. After finishing a box bending sequence the system must return to normal mode of operation automatically. All strokes with blanked front beam at full speed need an additional or separate deliberate command (e.g. reapplication of foot pedal or push one additional button). In other case the beam works in slow speed.</p> <p>Hint:</p> <p>VG3 considers that there is a discrepancy between prEN12622:2003/10 and previous prEN12622:2001/10 (concerning paragraph b of 5.2.5.5.3 and the reference taken from paragraph d and e).</p> <p>Adaptation procedure: FORMAL ADAPTATION IN CONFORMITY WITH DIRECTIVE 2006/42/EC</p>		

(1) Essential health and safety requirement

Note: According to point 6.6 of the Guide of the implementation of directives based on the New Approach and the Global Approach, the notified bodies apply as general guidance this recommendation for use.

	CO-ORDINATION OF NOTIFIED BODIES Machinery Directive 2006/42/EC + Amendment RECOMMENDATION FOR USE	CNB/M/03.179 Revision 04 Language: E
Date of first stage: 08/06/2004	To be approved by:	Approved on:
Origin: VG3 Presses for the cold working of metals	<input checked="" type="checkbox"/> Vertical Group <input checked="" type="checkbox"/> Horizontal Committee	29/09/2009 09/12/2004
	To be endorsed by:	Endorsed on:
	<input checked="" type="checkbox"/> Machinery Working Group....	24/05/2005
Question related to: Directive 2006/42/EC	Article:	EN/prEN: EN 12622:2001
Annex: I	ESR (1): 1.2.5	Other:
		Other clause:
		GEN TC concerned: TC 143
Key words: Press-brakes - Working with one side guard open		
Question:		
Which requirements shall be adopted to work with one or both of the interlocked side guards open?		
Solution:		
Either		
A) a key selector shall be installed that sets the slow closing speed (10 mm/s) and slow speed (2 m/min) of the back gauge over the full stroke or		
B) the opening of one or both side guards shall		
<input checked="" type="checkbox"/> always stop both the closing movement and slow speed movement, and make it necessary to release and reapply the control (foot pedal) to restart the closing movement, and		
<input checked="" type="checkbox"/> automatically set the slow closing speed (10 mm/s) and slow speed (2 m/min) of back gauge over the full stroke.		
The automatic opening of the press when at full speed should only be possible if no hazard is introduced by the opening stroke.		
If a lateral guard is closed during a slow speed closing operation, this movement may only continue at slow speed. To return to a high speed operation after closing the lateral guards, shall only be possible by reactivating the control (foot pedal). (see 5.4.1.1 b) EN 12622:2001)		
Adaptation procedure: FORMAL ADAPTATION IN CONFORMITY WITH DIRECTIVE 2006/42/EC		

(1) Essential safety requirement

Note: According to point 6.6 of the Guide of the implementation of directives based on the New Approach and the Global Approach, the notified bodies apply as general guidance this recommendation for use.

	CO-ORDINATION OF NOTIFIED BODIES Machinery Directive 2006/42/EC + Amendment RECOMMENDATION FOR USE		CNB/M/03.180 Revision 04 Language: E
Date of first stage: 08/06/2004	To be approved by:		Approved on:
Origin: VG3 Presses for cold working metals	<input checked="" type="checkbox"/> Vertical Group..... <input checked="" type="checkbox"/> Horizontal Committee To be endorsed by: <input checked="" type="checkbox"/> Machinery Working Group...		28/09/2009 09/12/2004 Endorsed on: 24/05/2005
Question related to: Dir. 2006/42/EC Annex: I	Article: EHSR (1): 1.3.8	EN/prEN: EN 12622:2001 Normative clause: 5.3.24.1 CEN TC concerned: TC 143	Other: Other clause:
Key words: Press-brakes - Ancillary devices - Powered tools clamping devices			
Question: 1. In some cases press brakes are fitted with pneumatic or hydraulic tools clamping devices. Which requirements shall be adopted to prevent fingers being trapped during the locking movement? 2. What measures have to be taken to ensure a secure and correct locking of the tools?			
Solution: 1. To prevent the fingers being trapped during tool setting the manufacturer of the press-brakes shall give clear instructions in the machines manual about the residual risk concerning clamping devices. 2. It has to be ensured, that a loss of pressure does not lead to an insecure tool. This might be achieved by a system consisting of a mechanical tool retention or security system (both preventing the tool from falling down) together with either a) a mechanical forced clamping (e.g. by spring force) pneumatic or hydraulic energy only being used to de-clamp the tool* or b) a positive clamping by use of pneumatic or hydraulic energy together with a pressure sensing device interlocked with a control system of the press-brakes according to category 2 of EN954-1:1996. * Single faults in clamping device shall not lead to loss of the clamping function.			
Adaptation procedure: FORMAL ADAPTATION IN CONFORMITY WITH DIRECTIVE 2006/42/EC			

(1) Essential health and safety requirement

Note: According to point 6.6 of the Guide of the implementation of directives based on the New Approach and the Global Approach, the notified bodies apply as general guidance this recommendation for use.

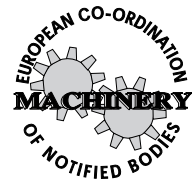
	<p>CO-ORDINATION OF NOTIFIED BODIES Machinery Directive 2006/42/EC + Amendment</p> <p>RECOMMENDATION FOR USE</p>	<p>CNB/M/03.182 Revision 04 Language: E</p>
<p>Date of first stage: 08/06/2004</p>	<p>To be approved by:</p>	<p>Approved on:</p>
<p>Origin: VG3 Presses for cold working metals</p>	<p><input checked="" type="checkbox"/> Vertical Group</p> <p><input checked="" type="checkbox"/> Horizontal Committee.....</p> <p>To be endorsed by:</p> <p><input checked="" type="checkbox"/> Machinery Working Group.</p>	<p>28/09/2009 09/12/2004 Endorsed on: 24/05/2005</p>
<p>Question related to: Dir. 2006/42/EC Article: Annex: I EHSR (1): 1.3.7, 1.3.8</p>	<p>EN/prEN: prEN 12622:2008 Normative clause: 5.1.1.5 n) CEN TC concerned: TC 143</p>	<p>Other: Other clause:</p>
<p>Key words: Press-brakes - ESPE using AOPD in the form of laser beams - Additional crushing hazard</p>		
<p>Question: How is it possible to avoid crushing between the safety device moving with the beam and any other part of the press-brakes?</p>		
<p>Answer: Doing the risk assessment about additional crushing hazards generated with these devices the normal consideration is to trap the hand.</p> <p>The following solutions solely or in combination may be helpful to ensure a sufficient level of safety.</p> <ol style="list-style-type: none"> 1. The AOPD moving with the beam has to be mounted in such a way, that it can be easily deflected by any part of the human body introduced beneath the moving part of the AOPD. 2. The distance between the edge of the safety device and the closest fixed parts of the press shall not be less than 100 mm (hands safety - EN 349:1993 + A1:2008). 3. The use of sensitive edges. <p>Adaptation procedure: FORMAL ADAPTATION IN CONFORMITY WITH DIRECTIVE 2006/42/EC</p>		

(1) Essential health and safety requirement
Note: According to point 6.6 of the Guide of the implementation of directives based on the New Approach and the Global Approach, the notified bodies apply as general guidance this recommendation for use.

	<p style="text-align: center;">CO-ORDINATION OF NOTIFIED BODIES Machinery Directive 2006/42/EC + Amendment</p> <p style="text-align: center;">RECOMMENDATION FOR USE</p>		CNB/M/03.185 Revision 05 Language: E
Date of first stage: 09/06/2004	To be approved by:		Approved on:
Origin: VG3 Presses for cold working metals	<input checked="" type="checkbox"/> Vertical Group <input checked="" type="checkbox"/> Horizontal Committee.....	30/09/2009 09/06/2005	
Question related to: Dir. 2006/42/EC Article: Annex: I EHSR (1): 1.4.2; 1.4.2.2		EN/prEN: EN 693:2001, EN 692:2005+A1:2009 Normative clause: 5.3 CEN TC concerned: TC 143/WG1	Other: Other clause:
Key words: Movable screens			
<p>Question:</p> <p>Q: 1. Which safeguarding is necessary for pneumatically or electrically vertically driven guards on a press when the guard is manoeuvred with ordinary two hand control or when a single hold-to-run pushbutton is used?</p> <p>Q: 2. When is it acceptable to use an impulse button as the control device for movable guard?</p> <p>Q: 3. When must fall arresters (anti-drop safeguards) as described in EN 12604 be used?</p>			
<p>Solution:</p> <p>The manufacturer has to do a risk assessment according to EN 954-1:1996 to define the preferable category for the control system of the movement of the door. During this assessment the manufacturer will have to judge if the kinetic energy of the movement of the guard is big enough to cause serious injury.</p> <p>A:1. When a two hand control or a hold to run pushbutton is used for the guard and the operator has a good view of the area around the door and of the tool area no other safety measures have to be taken. The force (pressure) must be lower than 150 N (50 N/cm²) or additional safeguarding measures have to be implemented in the trapping zone generated by the guards.</p> <p>A: 2. Always if the operator has a good view of the area around the door and of the tool area and it is not possible to enter the danger zone during the closing movement of the guard and if one of the following conditions is fulfilled:</p> <ul style="list-style-type: none"> - the requirements of 5.2.5.2 of EN 953:2009 are fulfilled (e.g. a sensitive edge that reverses the door in case of obstruction is installed) <p>or</p> <ul style="list-style-type: none"> - there is no danger presented by the guard. <p>A: 3. If one single mechanical fault leads to an unintended gravity fall causing a force exceeding 150 N additional safe guarding measures shall be taken into consideration (e.g. fall arresters, double independent drive systems, over dimensioning of critical parts or other solutions as described in EN 12604).</p> <p>Adaptation procedure: FORMAL ADAPTATION IN CONFORMITY WITH DIRECTIVE 2006/42/EC</p>			

(1) Essential health and safety requirement

Note: According to point 6.6 of the Guide of the implementation of directives based on the New Approach and the Global Approach, the notified bodies apply as general guidance this recommendation for use.

	CO-ORDINATION OF NOTIFIED BODIES Machinery Directive 2006/42/EC + Amendment RECOMMENDATION FOR USE		CNB/M/03.186 Revision 06 Language: E
Date of first stage: 09/06/2004	To be approved by:		Approved on:
Origin: VG3 Presses for cold working metals	<input checked="" type="checkbox"/> Vertical Group	28/09/2009	
	<input checked="" type="checkbox"/> Horizontal Committee.....	26/11/2009	
	To be endorsed by:		Endorsed on:
	<input checked="" type="checkbox"/> Machinery Working Group.	26/05/2010	
Question related to: Dir. 2006/42/EC Article: Annex: IV-9 EHSR (1):	EN/prEN: EN692:2005+A1:2009(1), Other: EN 693:2001+A1:2009(2), EN 12622:2001(3), Normative clause: 5.4.4 (1), 5.4.3 Other clause: (2), 5.4.2 (3), CEN TC concerned: TC 143		
Key words: Acceptability of a component, configurable or parameterizable PES			
Question: Should a manufacturer of a press, that relies on the below described PES to manage the safety control functions of the machine have carried out an EC type examination or produce the machine using a full quality assurance system approved by a notified body according to annex X of the Machinery Directive 2006/42/EC or not ?			
Description: According to above mentioned clauses the safety related functions of presses shall not rely solely on a PES. Recently several safety programmable electronic systems (SPES) have appeared on the market referred as configurable safety relay, or parameterizable safety unit, etc. These systems differ from the freely-programmable safety control systems in the following features: The function blocks are already programmed and certified. Programming an application consist of doing the following steps, in a graphical user-interface: a) Choosing the input functions (icon boxes), unfolding input function windows for setting their specific parameters and assigning connection terminals to the input functions b) Doing the same for the output functions c) Calling the linking functions (AND, OR, etc.) and d) Wiring all blocks; The user does not need to develop a complex programme properly, but these systems are also considered to be PES. Some systems are dedicated to an application and the main part of the logic is already programmed, so the manufacturers of the machines only have to properly parameterize (tailor) the system to its own application. Solution: Yes, Manufacturers of annex IV machinery are obligated to follow EC type examination procedure or manufacture using a full quality assurance system as described above as long as these types of safety systems are excluded from above mentioned harmonised standards.			

(1) Essential health and safety requirement

Note: According to point 6.6 of the Guide of the implementation of directives based on the New Approach and the Global Approach, the notified bodies apply as general guidance this recommendation for use.

	CO-ORDINATION OF NOTIFIED BODIES Machinery Directive 2006/42/EC + Amendment RECOMMENDATION FOR USE	CNB/M/03.187 Revision 05 Language: E
Date of first stage: 09/06/2004	To be approved by:	Approved on:
Origin: VG3 Presses for cold working metals	<input checked="" type="checkbox"/> Vertical Group <input checked="" type="checkbox"/> Horizontal Committee..... To be endorsed by: <input checked="" type="checkbox"/> Machinery Working Group.	30/09/2009 09/06/2005 Endorsed on: 29/10/2005
Question related to: Dir. 2006/42/EC Article: Annex: I EHSR (1): 1.2; 1.3.2	EN/prEN: EN 692:2005+A1:2009 Normative clauses: 5.2.6, 5.2.6.4 CEN TC concerned: TC 143	Other: Other clause:
Key words: failure of auxiliary powered functions for setting		
<p>Question:</p> <p>Automatic systems to facilitate the tool setting of presses, such as powered drives for slide and stroke adjustment and for their locking (e.g. clamping devices of the eccentric and the screw) are available on the market. It is intended that they are manually initiated via a deliberate/intended action.</p> <p>EN 692 clause 5.2.6 specifies requirements for interlocks between control circuits of drives and clutches and also to ensure the locking of adjustments during production (5.2.6.4).</p> <p>Therefore:</p> <p>a) Which categories shall control circuits for powered slide adjustment (e.g. control of position of the eccentric and other associated bars) conform to in the case of manual loaded and/or unloaded mechanical presses?</p> <p>b) Which categories shall control circuits for the stroke adjustment (e.g. control of the correct clamping of the screw) conform to</p> <ul style="list-style-type: none"> • in the case of manual loaded and/or unloaded mechanical presses? 		
<p>Answer:</p> <p>Firstly, these functions shall only be available in setting mode:</p> <p>a) The control circuits for locking powered slide adjustment in the correct position for production mode shall at least conform to Category 1. Additionally the position of the clamping devices shall be monitored. This function must be automatically tested at least at each of tool setting.</p> <p>b) The control circuits for locking the powered stroke adjustment in the correct position for production mode shall at least conform to Category 1.</p>		
Adaptation procedure: FORMAL ADAPTATION IN CONFORMITY WITH DIRECTIVE 2006/42/EC		

(1) Essential health and safety requirement

Note: According to point 6.6 of the Guide of the implementation of directives based on the New Approach and the Global Approach, the notified bodies apply as general guidance this recommendation for use.

	CO-ORDINATION OF NOTIFIED BODIES Machinery Directive 2006/42/EC + Amendment RECOMMENDATION FOR USE		CNB/M/03.188 Revision 06 Language: E
Date of first stage: 07/06/2004	To be approved by:		Approved on:
Origin: VG3 Presses for cold working metals	<input checked="" type="checkbox"/> Vertical Group..... <input checked="" type="checkbox"/> Horizontal Committee	28/09/2009 10/08/2008	
Question related to: Dir. 2006/42/EC Article: Annex: I EHSR (1): 1.4.2.2		EN/prEN: EN 692: 2005, EN 693 :2001 Normative clause: CEN TC concerned: TC 143	Other: EN 13736:2003 Other clause:
Key words: Front guard switch			
Question: Is only one non mechanical actuated switching unit consisting of one active and one inactive part (e.g. a magnetic switch) acceptable for interlocking a cyclic front guard of a press?			
Solution : Yes, if: <ul style="list-style-type: none"> - The switching unit and the safety logic fulfil category 4 of EN 954-1 (redundant and monitored) and - A cyclic test (at least once per stroke) is done in any operational mode to verify that the moving part of the switching unit is not attached to the other part permanently. A negative test result shall lead to a prevention of further stroke initiation. The cyclic test can be done e.g. by a standard PLC. <p>If a cyclic test can not be done (e.g. when the press can be operated also in automatic mode) the switching unit shall be mounted so that the actuating part of the unit can not be removed for the purpose of disabling the safety system (see EN 1088:1995/prA1:2005). The parts of the switching unit must then be a “unique” pair.</p> <p>“Unique” means that it is unlikely to find another matching part that can be used to defeat the protective system.</p> <p>Adaptation procedure: FORMAL ADAPTATION IN CONFORMITY WITH DIRECTIVE 2006/42/EC</p>			

(1) Essential health and safety requirement
 Note: According to point 6.6 of the Guide of the implementation of directives based on the New Approach and the Global Approach, the notified bodies apply as general guidance this recommendation for use.

	CO-ORDINATION OF NOTIFIED BODIES Machinery Directive 2006/42/EC + Amendment RECOMMENDATION FOR USE	CNB/M/03.189 Revision 05 Language: E
Date of first stage: 31/08/2005	To be approved by:	
Origin: VG3 Presses for cold working metals	<input checked="" type="checkbox"/> Vertical Group <input checked="" type="checkbox"/> Horizontal Committee	Approved on: 30/09/2009 21/11/2005
		To be endorsed by: <input checked="" type="checkbox"/> Machinery Working Group.
Question related to: Dir. 2006/42/EC	Article:	EN/prEN: EN 1088:1995 +A2:2008
Annex: I	EHSR (1): 1.4.1	Other:
		Normative clause: Other clause:
		CEN TC concerned:
Key words: Defeat of protective measures on presses		
Question: Which methods may be used to prevent unauthorized loosening or tampering of screws/settings when the risk of manipulation is high and the manipulation will not be detected by the control system for: <ul style="list-style-type: none"> • Interlock switches and their keys • Non-mechanical interlock switches (e.g. magnetic, proximity switches) • Press table extensions used to prevent standing behind the light curtain considering that these extensions sometimes are damaged and therefore it must be possible to change/repair them Adjustable hydraulic valves/safety valves		
Solution: Answer : Possible methods are those ones where the destruction of the fastener is necessary for disassembling, e.g.: <ul style="list-style-type: none"> • One way screws • Screws with destroyed head e.g. drilled out or epoxy filled allen/torx/Phillips/pozidrive screw • Spot welded screws • Spot welding on the part itself • Riveting • Sealing with lead or similar methods is only acceptable to prevent from unauthorized manipulation of valves The use of "safety screws" which can be loosened with a special tool without destroying them is not considered to be sufficient for fixing a single interlocking switch. See EN 1088:1995/prA1:2004 (ISO/TC 199 WG 7 N0006) Adaptation procedure: FORMAL ADAPTATION IN CONFORMITY WITH DIRECTIVE 2006/42/EC		

(1) Essential Health and Safety Requirement

Note: According to point 6.6 of the Guide of the implementation of directives based on the New Approach and the Global Approach, the notified bodies apply as general guidance this recommendation for use.

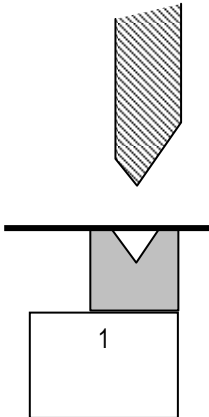
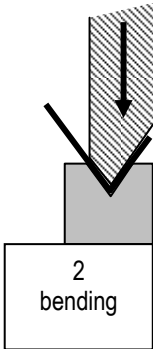
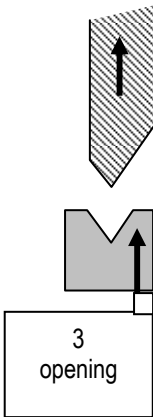
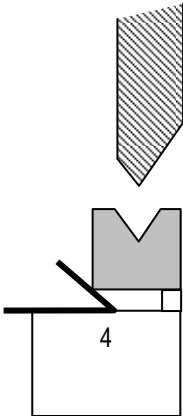
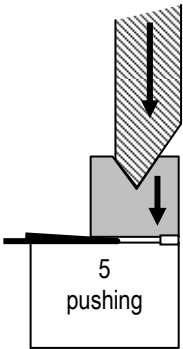
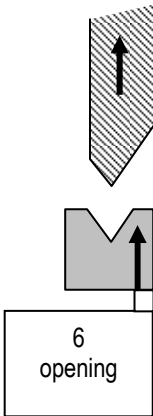
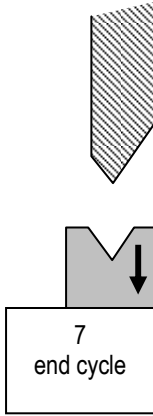
	<p>CO-ORDINATION OF NOTIFIED BODIES Machinery Directive 2006/42/EC + Amendment</p> <p>RECOMMENDATION FOR USE</p>	<p>CNB/M/03.192 Revision 04 Language: EN</p>
<p>Date of first stage: 21/03/2006</p> <p>Origin: VG3 Presses for cold working metals</p>	<p>To be approved by:</p> <p><input checked="" type="checkbox"/> Vertical Group.....</p> <p><input checked="" type="checkbox"/> Horizontal Committee</p> <p>To be endorsed by:</p> <p><input checked="" type="checkbox"/> Machinery Working Group.</p>	<p>Approved on:</p> <p>06/10/2008</p> <p>09/12/2008</p> <p>Endorsed on:</p> <p>18/06/2009</p>
<p>Question related to: Dir. 2006/42/EC Article:</p> <p>Annex: 1 EHSR (1):</p>	<p>EN/prEN: EN 12622:2001</p> <p>Normative clause:</p> <p>CEN TC concerned: TC 143</p>	<p>Other: pr EN 12622:2007</p> <p>Other clause :</p>
<p>Key words: Press brakes – secondary working devices</p>		
<p>Question:</p> <p>Some press bakes are equipped with secondary devices (e.g. bend and push devices) which don't stand in he bending zone but can use the down stroke movement to perform the operation. This equipment is usually pneumatic with at least two single effect cylinders.</p> <p>What should the safety devices of this secondary working part be?</p> <div style="display: flex; flex-wrap: wrap; justify-content: space-around;">        </div>		

Solution:

This type of tool has two danger zones. The first danger zone (a) is between the main tool and secondary tool and the second danger zone (b) is underneath the secondary tool.

- (a) The closing movement of the main tool should be protected with suitable safeguards.
The relationship of the movements between the main and the secondary tool need to be protected to prevent crushing between the main and the secondary tool in normal operation and due to unintended opening of the secondary tool
- (b) If the gap within the secondary tool is less or equal to 6mm the closing movement is not considered to be dangerous.
If the gap within the secondary tool is greater than 6mm a crushing hazard exists therefore the closing movement should be protected with suitable safeguards.

Suitable safeguards to address (a) and (b) above could be:

- Light curtains of type 4 according to EN 61496-1 which stop the closing movement of the beam and any movement of the secondary tool as soon they are interrupted in combination with monitoring and inbuilt redundancy of the drive of the secondary tool (see also EN 13736 pneumatic presses).

or

- A hold-to-run control device in conjunction with a maximum speed of 10mm/s (safe or monitored by a system of cat. 3 acc. to EN 954-1 or PL_D acc. to EN 13849-1) of the secondary tool for the initiation of the closing and opening movement of the secondary tool when used in combination with interlocking which prohibits any upward movement of the secondary tool as long as the main tool is in down stroke mode.

or

- A hold-to-run control device in conjunction with a maximum speed of 10mm/s (safe or monitored by a system of cat. 3 acc. to EN 954-1 or PL_D acc. to EN 13849-1) of the secondary tool for the initiation of the closing movement of the secondary tool when used in combination with
 - synchronisation (of cat. 3 acc. to EN 954-1 or PL_D acc. to EN 13849-1) between the upward movement of the main and the secondary tool in a manner that ensures that the speed of the main tool is always higher than the speed of the secondary tool so that the gap between the tools is always increasing during this movement

or

- a system of category 3 according to EN 954-1 or PL_D according to EN 13849-1 preventing the opening of the secondary tool as long as the beam has not reached a minimum distance from the secondary tool of 100 mm plus the stroke of the secondary tool.

Adaptation procedure: FORMAL ADAPTATION IN CONFORMITY WITH DIRECTIVE 2006/42/EC

(1) Essential health and safety requirement

Note: According to point 6.6 of the Guide of the implementation of directives based on the New Approach and the Global Approach, the notified bodies apply as general guidance this recommendation for use.

	CO-ORDINATION OF NOTIFIED BODIES Machinery Directive 2006/42/EC + Amendment RECOMMENDATION FOR USE	CNB/M/03.194 Revision 05 Language: E
Date of first stage: 03/03/2008	To be approved by:	Approved on:
Origin: VG3 Presses for cold working of metals	<input checked="" type="checkbox"/> Vertical Group	03/03/2009
	<input checked="" type="checkbox"/> Horizontal Committee	10/06/2009
Question related to: Directive 2006/42/EC Article: Annex: I ESR (1): 1.2.6	EN/prEN: EN 692:2005, EN 693:2001, EN 12622:2001	Other:
	Clause:	Other clause:
	CEN TC concerned:	
Key words: Servo press (Power Presses & Press Brakes), brake		
Question: What kind of brake system could be used on a mechanical press without a clutch, driven by a servo-drive system?		
Solution: If the servo controller provides a safe torque off function (STO) according to ISO 13849-1:2006 category 4 PL e, a stop category 1 acc. to EN 60204-1:2007 and a stopping performance monitoring according to ISO 13849-1:2006 PL d the following solutions may be acceptable: External mechanical brakes shall be used. They shall be mechanically and positively linked to the ram. If no mechanical and positive link is realised equivalent measures shall be taken. Circuits driving the brake systems shall be designed and monitored according to the needs of the safety control system. a) If the stopping time is relevant (depending on the safeguarding system e.g. non physical barrier) fail safe brake systems (e.g. a single brake as specified in EN 692 or equivalent) shall be used and a test of the brake performance has to be done to show the sufficient friction of the brake. If this test is done in a stand still position, it must be shown that also the stopping time under worst case conditions will be guaranteed. The interpretation of the test result must be done by the safety control system. The test has to be done at each power on, at each change of operational mode and at least after one hour of operation in single stroke mode or after eight hours of operation in automatic mode. The relevant sections of Annex B.4 of EN 692:2005 shall be taken into consideration for the design and testing of the brake. b) If the stopping time is not relevant a spring operated park brake system alone may be enough. In any case the stand still of the ram shall be monitored. The braking torque of external mechanical brakes preventing descent of the load (normally the ram) shall be reasonably overdimensioned (recommended value 1,25) with respect to the total mass of the ram including fitted tooling. Note: STO is defined in IEC 61800-5-2:2007		

(1) Essential safety requirement

Note: According to point 6.6 of the Guide of the implementation of directives based on the New Approach and the Global Approach, the notified bodies apply as general guidance this recommendation for use.

	<p>CO-ORDINATION OF NOTIFIED BODIES Machinery Directive 2006/42/EC + Amendment</p> <p>RECOMMENDATION FOR USE</p>	<p>CNB/M/03.196 Revision 04 Language: E</p>
<p>Date of first stage: 07/10/2008</p>	<p>To be approved by:</p>	<p>Approved on:</p>
<p>Origin: VG3 Presses for the cold working of metals</p>	<p><input checked="" type="checkbox"/> Vertical Group..... <input checked="" type="checkbox"/> Horizontal Committee</p> <p>To be endorsed by :</p> <p><input checked="" type="checkbox"/> Machinery Working Group</p>	<p>07/10/2008 09/12/2008</p> <p>Endorsed on : 18/06/2009</p>
<p>Question related to: Dir. 2006/42/EC Article: Annex: 1 EHSR (1):</p>	<p>EN/prEN: Normative clause: CEN TC concerned: TC 143</p>	<p>Other: Other clause :</p>
<p>Key words: Servo presses, protective measures</p>		
<p>Question: What kind of protective measures are acceptable for servo presses?</p>		
<p>Solution: It is recognised that servo-presses have similar features to both mechanical and hydraulic presses. Therefore the protective measures as described in EN 692, EN 693 or EN 12622 are found acceptable on servo presses. The level of safety shall not be lower than the one in the indicated standards.</p> <p>Adaptation procedure: FORMAL ADAPTATION IN CONFORMITY WITH DIRECTIVE 2006/42/EC</p>		

(1) Essential health and safety requirement
Note: According to point 6.6 of the Guide of the implementation of directives based on the New Approach and the Global Approach, the notified bodies apply as general guidance this recommendation for use.

	CO-ORDINATION OF NOTIFIED BODIES Machinery Directive 2006/42/EC + Amendment RECOMMENDATION FOR USE		CNB/M/03.200 Revision 05 Language: E
Date of first stage: 25/09/2008	To be approved by:		Approved on:
Origin: VG3 Presses for the cold working of metals	<input checked="" type="checkbox"/> Vertical Group <input checked="" type="checkbox"/> Horizontal Committee		03/03/2009 10/06/2009
	To be endorsed by: <input checked="" type="checkbox"/> Machinery Working Group....		Endorsed on: 25/12/2009
Question related to: Directive 2006/42/EC Article: Annex: I ESR (1): 1.2.4	EN/prEN: EN 692:2005, EN 693:2001, EN 12622:2001 Clause: CEN TC concerned:		Other: Other clause:
Key words: Servo-presses (Power Presses & Press Brakes), Stopping performance monitoring			
Question: Stopping performance monitoring on servo - presses Which solution is acceptable?			
Solution: Where the response time (stopping performance) of a servo-press is safety-relevant, the response time has to be determined taking into account all errors concerning safety. If it is not possible for the press's safety control system to detect certain faults at least at the following check, the (additional) occurrence of further faults must be assumed. The effect of any assumable fault on the response time of the stopping function has to be taken into account for the calculation of the safety distance.			

(1) Essential safety requirement

Note: According to point 6.6 of the Guide of the implementation of directives based on the New Approach and the Global Approach, the notified bodies apply as general guidance this recommendation for use.

 <p>EUROPEAN CO-ORDINATION MACHINERY OF NOTIFIED BODIES</p>	<p>CO-ORDINATION OF NOTIFIED BODIES Machinery Directive 2006/42/EC + Amendment</p> <p>RECOMMENDATION FOR USE</p>	<p>CNB/M/03.201 Revision 05</p> <p>Language: E</p>
Date of first stage: 25/09/2008	To be approved by:	
Origin: VG3 Presses for the cold working of metals	<input checked="" type="checkbox"/> Vertical Group <input checked="" type="checkbox"/> Horizontal Committee	Approved on: 04/03/2009 10/06/2009
		To be endorsed by: <input checked="" type="checkbox"/> Machinery Working Group....
Question related to: Directive 2006/42/EC Article: Annex: I ESR (1): 1.2.1, 1.2.3	EN/prEN: EN 692:2005, EN 693:2001, EN 12622:2001 Clause: CEN TC concerned:	Other: Other clause:
Key words: Servo-presses (Power Presses & Press Brakes), STO, prevention of unintended start		
Question: Which category / performance level is necessary for the safe torque off (STO) function of each drive of a press slide driven by more than one servo drive?		
Solution: The current power press standards as well as the press brake standard require category 4 of EN 954-1:1996 for the overall stopping performance of the slide. This general requirement is also valid for servo presses. With respect to the new standard EN ISO 13849-1:2008 the corresponding requirement is PL e and category 4. Where the unexpected start of one of the drives cannot lead to significant slide movement (e.g. not more than 6 mm) because the slide is blocked due to the mechanical construction of the press the category and performance level of the STO of each drive may be of the next lower level compared to the level required for a press with a single servo drive as long as the performance level stays equal to or above d.		

(1) Essential safety requirement

Note: According to point 6.6 of the Guide of the implementation of directives based on the New Approach and the Global Approach, the notified bodies apply as general guidance this recommendation for use.

	<p>CO-ORDINATION OF NOTIFIED BODIES</p> <p>Machinery Directive 2006/42/EC + Amendment</p> <p>RECOMMENDATION FOR USE</p>	<p>CNB/M/03.202 Revision 04</p> <p>Language: E</p>
Date of first stage: 03/03/2009	To be approved by:	Approved on:
Origin: VG3 Presses for the cold working of metals	<input checked="" type="checkbox"/> Vertical Group	03/03/2009
	<input checked="" type="checkbox"/> Horizontal Committee	10/06/2009
Question related to: Directive 2006/42/EC Annex: I Article: ESR (1): 1.3.7	To be endorsed by:	Endorsed on:
	<input checked="" type="checkbox"/> Machinery Working Group....	25/12/2009
	EN/prEN: EN 12622:2009 Clause: 5.3.21 CEN TC concerned: TC 143	Other: Other clause:
Key words: Press brakes – back gauge movement initiation		
<p>Question:</p> <p>Which alternative protective measures besides those described in clause 5.3.21 of EN 12622:2009 are acceptable to protect operators against hazardous movements of back gauges?</p>		
<p>Solution:</p> <p>It is also acceptable to protect the operator against the hazards arising from the movement of automatically operated back gauges by light curtains (e.g. the light curtain which also protects against access to the press from the front).</p> <p>If none of the features “movement initiation by the operator” or “demarcation of a zone with reduced speed / limited force” or “protection by light curtain” is active for protection against movement of the back gauges, no movement of the back gauges shall be possible.</p>		

(1) Essential safety requirement

Note: According to point 6.6 of the Guide of the implementation of directives based on the New Approach and the Global Approach, the notified bodies apply as general guidance this recommendation for use.

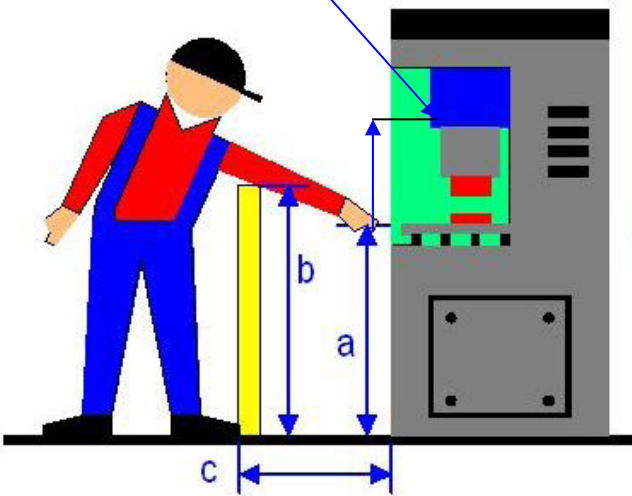
	CO-ORDINATION OF NOTIFIED BODIES Machinery Directive 2006/42/EC + Amendment RECOMMENDATION FOR USE	CNB/M/03.204 Revision 03 Language: E
Date of first stage: 28/09/2011	To be approved by:	Approved on:
Origin: VG3 Presses for cold working metals	<input checked="" type="checkbox"/> Vertical Group <input checked="" type="checkbox"/> Horizontal Committee To be endorsed by: <input checked="" type="checkbox"/> Machinery Working Group....	28/09/2011 11/12/2012 Endorsed on: 04/06/2013
Question related to: Directive 2006/42/EC Article: Annex: ESR (1): 1.4.2., 1.4.3.	EN/prEN: EN 692 :2005+A1:2009, EN 693 :2001+A2:2011 Clause: 5.3.2 CEN TC concerned: TC 143 and ISO TC 39/SC 10	Other: EN ISO 13857:2008, 13855:2010 Other clause:
Key words: Presses – Safety distances		
<p>Question:</p> <p>Where a movable or a fixed guard is used to prevent the access to the tools area of presses the Table 1 or 2 of EN ISO 13857:2008 standard shall be checked to verify that it is impossible reaching over the protective structure. In the same way if a light curtain is installed the EN ISO 13855:2010 table 1 shall be verified.</p> <p>To do this it is necessary to fix the height of the hazard zone that is the closing area between the fixed half tool and the movable half tool.</p> <p>How it is possible to identify this hazard zone when the height of the two separate mould halves is unknown?</p>		
<p>Solution:</p> <p>In principle it is impossible to define a minimum or a maximum height of the tools.</p> <p>The dimension of the hazard zone is basically defined by value "a" as determined during the examination considering any possible situation from the maximum opening of the ram to the height of the table.</p> <p>"c" and "b" must be determined according to EN ISO 13857 and EN ISO 13855 considering:</p> <ul style="list-style-type: none"> - the stopping time and - either the maximum size of the table/ram or the maximum size of the tool whichever is larger. <p>Maximum ram opening position</p>  <p>"a", "b" and "c" are those defined in the corresponding standard (EN ISO 13857 or EN ISO 13855) depending of the safety device</p>		

(1) Essential safety requirement

Note: According to point 6.6 of the Guide of the implementation of directives based on the New Approach and the Global Approach, the notified bodies apply as general guidance this recommendation for use.

	CO-ORDINATION OF NOTIFIED BODIES Machinery Directive 2006/42/EC + Amendment RECOMMENDATION FOR USE	CNB/M/03.206 Revision 03 Language: E
Date of first stage: 27/09/2012	To be approved by:	Approved on:
Origin: VG3 Presses for cold working metals	<input checked="" type="checkbox"/> Vertical Group	27/09/2012
	<input checked="" type="checkbox"/> Horizontal Committee	11/12/2012
Question related to: Directive 2006/42/EC Article: Annex: I ESR (1): 1.4.3.	To be endorsed by:	Endorsed on:
	<input checked="" type="checkbox"/> Machinery Working Group....	04/06/2013
	EN/prEN: EN 692 :2005+A1:2009 Clause: 5.3.2. CEN TC concerned: TC 143	Other: EN 693: 2001+A2:2011 Other clause:5.3.16
Key words: Presses – Two hand control device (THCD)		
Question: Can the THCD be used as the solely protection device for a press at the operator side?		
Solution: According to EN 692:2005+A1:2009 clause 5.3.2. the manufacturer shall select the safeguard method which reduces the risks as far as possible, considering the significant hazards and the method of protection. The operator(s) must have the possibility to overview all the dangerous area at any time (considering the presence of tools and material). It is recommended that if the horizontal access is more than 650 mm [ref EN 693:2001+A2:2011 clause 5.3.16] other safeguarding devices than THCD according to the risk assessment for the particular press should be provided to protect a third person.		

(1) Essential safety requirement

Note: According to point 6.6 of the Guide of the implementation of directives based on the New Approach and the Global Approach, the notified bodies apply as general guidance this recommendation for use.

	<p>CO-ORDINATION OF NOTIFIED BODIES Machinery Directive 2006/42/EC + Amendment</p> <p>RECOMMENDATION FOR USE</p>		<p>CNB/M/03.207 Revision 03 Language: E</p>					
<p>Date of first stage: 27/09/2012</p> <p>Origin: VG3 Presses for cold working metals</p>	<p>To be approved by:</p> <p><input checked="" type="checkbox"/> Vertical Group</p> <p><input checked="" type="checkbox"/> Horizontal Committee</p> <p>To be endorsed by:</p> <p><input checked="" type="checkbox"/> Machinery Working Group....</p>	<p>Approved on:</p> <p>27/09/2012 11/12/2012</p> <p>Endorsed on:</p> <p>04/06/2013</p>						
<p>Question related to: Directive 2006/42/EC Article:</p> <p>Annex: I ESR (1): 1.3.7.</p>	<table border="0" style="width: 100%;"> <tr> <td>EN/prEN: EN 12622: 2009</td> <td>Other: EN 13849-1:2008</td> </tr> <tr> <td>Clause: 5.2.5.6.</td> <td>Other clause:</td> </tr> <tr> <td colspan="2">CEN TC concerned: TC 143</td> </tr> </table>		EN/prEN: EN 12622: 2009	Other: EN 13849-1:2008	Clause: 5.2.5.6.	Other clause:	CEN TC concerned: TC 143	
EN/prEN: EN 12622: 2009	Other: EN 13849-1:2008							
Clause: 5.2.5.6.	Other clause:							
CEN TC concerned: TC 143								
<p>Key words: Press-brakes – Powered work-piece supports</p>								
<p>Question:</p> <p>EN 12622: 2009 clause 5.2.5.6 c) requires that the unexpected start-up for powered work-piece supports shall be prevented when a hold-to-run control is used.</p> <p>How can be implemented in the control circuit?</p>								
<p>Solution:</p> <p>The control circuit of the hold-to-run control shall conform at least PLr=b EN 13849-1:2008.</p> <p>Explanation: according to EN 13849-1:2008:</p> <ul style="list-style-type: none"> S=1 due to reversible injury, F=2 due to permanent work place, P=1 due to sufficient space around and below the work-piece support. 								

(1) Essential safety requirement
 Note: According to point 6.6 of the Guide of the implementation of directives based on the New Approach and the Global Approach, the notified bodies apply as general guidance this recommendation for use.

	CO-ORDINATION OF NOTIFIED BODIES Machinery Directive 2006/42/EC + Amendment		CNB/M/03.210 Revision 04
Date of first stage: 25/09/2014	To be approved by:		Approved on:
Origin: N.B. 0404	<input checked="" type="checkbox"/> Vertical Group <input checked="" type="checkbox"/> Horizontal Committee To be endorsed by: <input checked="" type="checkbox"/> Machinery Working Group....		24/09/2015 02/12/2015 23/09/2016
Question related to: Directive 2006/42/EC Annex: I	Article: ESR (1): 1.3.2	EN/prEN: EN 692:2005+A1:2009 Clause: 5.2.1.4 CEN TC concerned:	Other: EN Other clause: 5.4.1.1
Key words: servo press / press brake – belt connection between motor and screw			
Question: How can the level of safety be kept on a servo press / press brake if the mechanical brake is placed on the servo motor shaft instead of the lead screw which is connected to the motor with a tooth belt			
Solution: See also CNB/M/03.194rev5 Two belts are needed, both monitored PL"d" (EN ISO 13849-1:2008) for breakage. One belt alone must be able to stop the ram (i.e. be able to transmit the nominal braking force) At least 8 consecutive teeth of each belt must be engaged in the pulley. Mechanical parts of shaft, pulleys, screws and their form fit connections shall be dimensioned according to well proven concepts. NOTE: for technical reasons a fault exclusion can be made for the loss of more than 4 teeth in consecutive raw The annual inspection of the machine would show any premature wear; annual inspection shall be stated in the user manual			

(1) Essential safety requirement

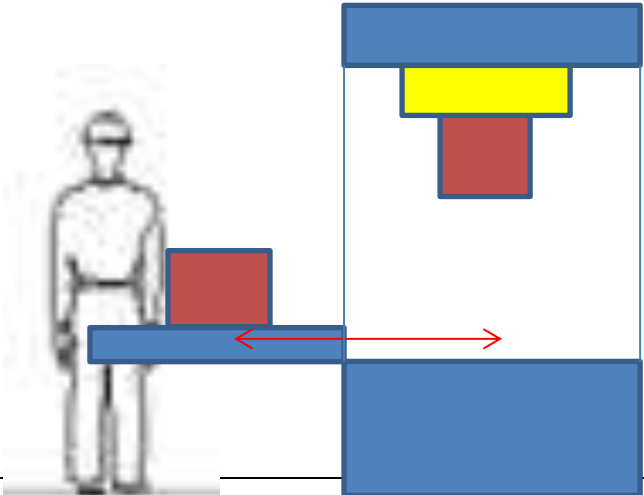
	CO-ORDINATION OF NOTIFIED BODIES Machinery Directive 2006/42/EC + Amendment		CNB/M/03.211 Revision 02
Date of first stage: 25/09/2014	To be approved by:	Approved on:	
Origin: N.B. 0026	<input checked="" type="checkbox"/> Vertical Group	26/09/2014	
	<input checked="" type="checkbox"/> Horizontal Committee	24/06/2015	
	To be endorsed by: <input checked="" type="checkbox"/> Machinery Working Group...	23/09/2016	
Question related to: Directive 2006/42/EC Annex: IV	Article: ESR (1):	EN/prEN: Clause: CEN TC concerned:	Other: Other clause:
Key words: presses – Manual loading/unloading work pieces in presses			
<p>Question:</p> <p>The work piece is manually placed on the lower die, which has been slid outside of the danger zone. When the work cycle starts the lower die first slides inside the danger zone and when in position the upper die moves downwards</p> <p>Are these machines included in annex IV?</p> 			
<p>Solution:</p> <p>NO: if the slide is an integrated auxiliary device of the press (the operator can only place the work piece outside the danger zone)</p> <p>YES: if the cycle gives the operator the possibility to place the work piece between the dies (e.g. two steps cycle)</p> <p>See also CNB/M/03.002 rev 15</p>			

(1) Essential safety requirement

F.1 Principle of interlocking corresponding to type III, using electromechanical components

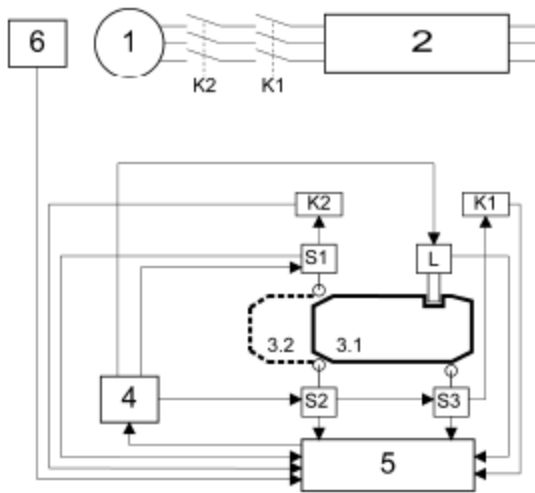

	CO-ORDINATION OF NOTIFIED BODIES Machinery Directive 2006/42/EC + Amendment RECOMMENDATION FOR USE	CNB/M/04.004 Revision 04 Language: E
Date of first stage: 25/07/1997	To be approved by:	Approved on:
Origin: VG4 Injection or compression moulding machine	<input checked="" type="checkbox"/> Vertical Group <input checked="" type="checkbox"/> Horizontal Committee..... To be endorsed by: <input checked="" type="checkbox"/> Working Group Machinery ...	25/08/2009 11/03/1997 Endorsed on: 08/06/1998
Question related to: Directive 2006/42/EC Annex: I ESR (1): 1.1.2.e	EN/prEN: Clause: CEN TC concerned:	Other:
Key words: Moulding machine. Essential equipments and accessories		
Question: How is it to be verified that the essential and special equipment and accessories necessary for the adjustment, servicing, and utilisation of moulding machines have been foreseen and can be used without risk?		
<p>Solution:</p> <p>The essential and special equipment and accessories to be supplied with moulding machines, so that they can be adjusted, serviced and used without risk are the tools, measuring instruments or equipments, adaptaters or accessories not currently found on the market and which are necessary, whether or not, to allow the user to carry out operations in conformity with the instructions contained in the handbook such as :</p> <ul style="list-style-type: none"> - a special spanner for no standardised nuts, - a specially designed tool allowing intervention on a component inaccessible by means of an everyday tool, - control instruments. <p>The verification consists of :</p> <ul style="list-style-type: none"> - ensuring that the instruction handbook gives a list of special equipment and accessories as well as pertinent instructions for their use, - ensuring, by evaluations or tests, that their use does not present a risk. <p>Adaptation procedure: FORMAL ADAPTATION IN CONFORMITY WITH DIRECTIVE 2006/42/EC</p>		



(1) Essential safety requirement

Note: According to point 6.6 of the Guide of the implementation of directives based on the New Approach and the Global Approach, the notified bodies apply as general guidance this recommendation for use.

	CO-ORDINATION OF NOTIFIED BODIES Machinery Directive 2006/42/EC + Amendment RECOMMENDATION FOR USE		CNB/M/04.005 Revision: 04 Language: E
Date of first stage: 25/07/1997	To be approved by:	Approved on:	
Origin: VG4 Injection or compression moulding machine	<input checked="" type="checkbox"/> Vertical Group <input checked="" type="checkbox"/> Horizontal Committee.....	25/08/2009 11/03/1997	
	To be endorsed by: <input checked="" type="checkbox"/> Machinery Working Group.....	Endorsed on: 08/06/1998	
Question related to: Directive 2006/42/EC Annex: I ESR (1): 1.1.3	EN/prEN: Other: Clause: CEN TC concerned:		
Key words: Moulding machines. Materials used during the construction of these machines			
Question: What is the nature and what are the limitations of the technical investigations to be carried out to ensure that an injection or compression moulding machine for plastics or rubber conforms to the essential requirements laid down in § 1.1.3. Annex I?			
<p>Solution: In general, the materials used during the construction of these machines do not present any intrinsic risk.</p> <p>Several types of fluids can be used :</p> <ul style="list-style-type: none"> - oil for the hydraulic circuit, - warming liquid, - cooling fluids, gas (nitrogen, etc.) <p>The inherent characteristics and hazards of these fluids must be indicated in the instruction handbook forwarded to the user.</p> <p>The machine manufacturer does not know the manufactured products in advance. In consequence, the requirement relative to these products cannot be verified during the EC type examination of injection or compression moulding machines for plastics and rubbers.</p> <p>However, the notified body must ensure the manufacturer point out in the instructions that potential risks resulting from use of some substances or mixtures exist.</p> <p>Adaptation procedure: FORMAL ADAPTATION IN CONFORMITY WITH DIRECTIVE 2006/42/EC</p>			

(1) Essential safety requirement

Note: According to point 6.6 of the Guide of the implementation of directives based on the New Approach and the Global Approach, the notified bodies apply as general guidance this recommendation for use.

	CO-ORDINATION OF NOTIFIED BODIES MACHINERY DIRECTIVE 2006/42/EC + Amendment RECOMMENDATION FOR USE		CNB/M/04.009 Revision: 08 Language: E
Date of first stage: 21/03/1997	To be approved by:		Approved on:
Origin : VG4 Injection or compression moulding machine	<input checked="" type="checkbox"/> Vertical Group <input checked="" type="checkbox"/> Horizontal Committee		25/08/2009 10/04/2007
	To be endorsed by:		Endorsed on:
	<input checked="" type="checkbox"/> Machinery Working Group.....		14/09/2007
Question related to: Dir. 2006/42/EC	Article:	EN/prEN: 289: 2004, EN 201: 1997	Other:
Annex: I	EHSR (1): 1.2.5	Normative clause: general	Other clause:
Key words : Moulding machinery / Automatic loading and unloading			
Question : What are the conditions under which loading and unloading of an injection or compression moulding machine can be considered as manual?			
Answer : Loading and unloading refers to the feed and/or removal of parts to/from the mould only. Loading and unloading is considered as automatic, if: <ul style="list-style-type: none">  The machine is designed to operate only with robot/manipulator equipment and no semi-automatic mode is possible; Or: <ul style="list-style-type: none">  The loading and unloading devices prevent the need to put the hands in the mould area Generally, this provision is implemented by clamping devices of the mould lower parts on a turn or shuttle table Loading and unloading of the parts take place outside the mould are (see figs. 2 and 3 in EN 201:1997). Access to the mould area must be prevented because of the distance or because of the provisions of guards (fixed or mobile). In all other cases, loading and unloading shall be considered as manual.			
Adaptation procedure: FORMAL ADAPTATION IN CONFORMITY WITH DIRECTIVE 2006/42/EC			

(1) Essential health and safety requirement

Note: According to point 6.6 of the Guide of the implementation of directives based on the New Approach and the Global Approach, the notified bodies apply as general guidance this recommendation for use.

Definitions for possible modes of operation (EUROMAP)::

(1) **Manual**

Where a machine is manually operated the functions of the machine are controlled via a hold-to-run control and are frequently possible only with reduced speeds/forces. Manual operation is used e.g. for setting; a production of parts is technically and economically not possible/sensible.

(2) **Semiautomatic**

Semiautomatic operation is a type of operation where one cycle is completed automatically after a start signal, then the machine stops, the next cycle can only take place if a further start signal has been given. Semiautomatic operation is used mainly if manual loading/unloading of the mould(s) is required.

(3) **Fully automatic**

Fully automatic operation is an operation where one cycle automatically follows the other; no intervention of the operator is necessary.

	CO-ORDINATION OF NOTIFIED BODIES Machinery Directive 2006/42/EC + Amendment RECOMMENDATION FOR USE	CNB/M/04.011 Revision: 04 Language: E
Date of first stage: 31/10/1997 Origin: VG4 Injection or compression moulding machine	To be approved by: <input checked="" type="checkbox"/> Vertical Group <input checked="" type="checkbox"/> Horizontal Committee..... To be endorsed by: <input checked="" type="checkbox"/> Machinery Working Group...	Approved on: 25/08/2009 18/09/1997 Endorsed on: 08/06/1998
Question related to: Directive 2006/42/EC Annex: I ESR (1): 1.3.8.2	EN/prEN: Other: Clause: CEN TC concerned:	
Key words: Moulding machinery / injection for plastics / light curtains /movable guards / mould protection		
Question: Which are the conditions for using light curtains instead of movable guards for the protection of the mould area of an injection moulding machine for plastics?		
Solution: For all machines, except machines with horizontal injection in line to the user, light curtains shall be : <ul style="list-style-type: none"> - covered by a certificate acceptable to the notified body and be of type IV in accordance with pr EN 61496-1:1997, - interlocked via hardware by two separate circuits on the directional control valve and the closing safety valve, the safe position of both valves is monitored at each cycle (the monitoring may be carried out by the programmable controller), - the safety distance given by the light curtain has to be taken into consideration (care must be taken also to other danger-zones than the tool-area, if they should be protected by the light curtain, e.g. a turn-table), - It must be impossible to step between light curtain and tool-area with the full body, - the gap between the upper and lower tool shall be covered in such a way that not hot material can injure the user (e.g. metal shield). - the dimensions of the machine should not exceed the following : <ol style="list-style-type: none"> a) horizontal machines: according EN 201 p.5.2.1.1.4, b) vertical machines: max. Stroke: 600 mm, max. Table: 1000 x 1000 mm (if both dim. are exceeding). <p>For larger machines additional safeguarding systems and risk analysis should be applied.</p> <p>Adaptation procedure: FORMAL ADAPTATION IN CONFORMITY WITH DIRECTIVE 2006/42/EC</p>		

(1) Essential safety requirement
 Note: According to point 6.6 of the Guide of the implementation of directives based on the New Approach and the Global Approach, the notified bodies apply as general guidance this recommendation for use.

	CO-ORDINATION OF NOTIFIED BODIES Machinery Directive 2006/42//EC + Amendment RECOMMENDATION FOR USE	CNB/M/04.013 Revision: 05 Language: E
Date of first stage: 02/12/1999	To be approved by:	Approved on:
Origin: VG4 Injection or compression moulding machine	<input checked="" type="checkbox"/> Vertical Group <input checked="" type="checkbox"/> Horizontal Committee..... To be endorsed by: <input checked="" type="checkbox"/> Machinery Working Group.....	25/08/2009 02/12/1999 Endorsed on: 09/04/2001
Question related to: Directive 2006/42/EC Annex: I ESR (1): clause 1.4.2.2	EN/prEN: EN 201: 1997 Clause: [(pr)EN] : 5.3.2, 5.4.3 CE TC concerned :	Other:
Key words: Injection moulding machine with fence; mechanical latch		
Question: A machine being larger than the dimensions given in pt. 5.3.2 of EN 201 is obliged to have a mechanical latch for the movable guard. If this machine is equipped with a fence and the rear movable guard is removed to give access for the robot, must the door in the fence carry this latch?		
Solution: No, because: - The door in the fence carries all safety-switches being necessary for the type III according to EN 201. - The closing of this door cannot lead to an unintended start of the machine, because of the installed acknowledgement system according to annex C of EN 201. This acknowledgement system should be realised as follow : a) All conditions of annex C fulfilled: A single acknowledgement system with push-button b) Not all conditions for annex C fulfilled (e.g. not a clear view of the danger area); A single acknowledgement system with key-switch or a double acknowledgement system with push-button inside the danger area. Adaptation procedure: FORMAL ADAPTATION IN CONFORMITY WITH DIRECTIVE 2006/42/EC		

(1) Essential safety requirement

Note: According to point 6.6 of the Guide of the implementation of directives based on the New Approach and the Global Approach, the notified bodies apply as general guidance this recommendation for use.

	CO-ORDINATION OF NOTIFIED BODIES Machinery-Directive2006/42/EC + Amendment RECOMMENDATION FOR USE	CNB/M/04.017 Revision 05 Language: E
Date of first stage: 02/12/1999	To be approved by:	Approved on:
Origin: VG4 Injection or compression moulding machine	<input checked="" type="checkbox"/> Vertical Group <input checked="" type="checkbox"/> Horizontal Committee..... To be endorsed by: <input checked="" type="checkbox"/> Machinery Working Group...	25/08/2009 02/12/1999 Endorsed on: 09/04/2001
Question related to: Directive 2006/42/EC Annex: I ESR (1): 1.2.2/1.3.8	EN/prEN: EN 201: 1997 Other: Clause: [(pr)EN] 5.3.1 CEN TC concerned:	
Key words : Stepping behind the rear guard of the mould area, Horizontal injection moulding machine		
<p>Question:</p> <p>Due to the provision of tubes and hoses, the area lying between the rear guard and the mould can often be entered even if there are no footboards. Usually, the clear width exceeds 150 mm. Which measures can prevent persons from stepping behind the rear guard of the mould area?</p>		
<p>Solution:</p> <p>The following measures can prevent persons from stepping behind the rear guard of the mould area:</p> <p>a) the leading edge of the movable guard (or the movable platen) shall be provided with a vertical bow that cannot be passed through by persons or</p> <p>b) a mechanical latch shall be provided which falls into a blocking position when the guard is opened so that the guard cannot be closed from the inside an unlatching is possible only from the outside.</p> <p>For small machines (distance between the bars < 1200 mm), no additional measures are necessary if the operator has a good view to those danger areas where persons can step in from that position where the machine can be started.</p> <p>The manufacturer shall give an information in his operation manual that the area behind the rear guard is not a designated working place. Otherwise, the requirements of EN 201, clause 5.3.1, have to be fulfilled.</p> <p>Adaptation procedure: FORMAL ADAPTATION IN CONFORMITY WITH DIRECTIVE 2006/42/EC</p>		

(1) Essential safety requirement

Note: According to point 6.6 of the Guide of the implementation of directives based on the New Approach and the Global Approach, the notified bodies apply as general guidance this recommendation for use.

	<p align="center">CO-ORDINATION OF NOTIFIED BODIES Machinery Directive 2006/42/EC + Amendments</p> <p align="center">RECOMMENDATION FOR USE</p>		CNB/M/04.029 Revision: 04 Language: E
Date: 24/05/2000	To be approved by:		Approved on:
Origin: VG4 Injection or compression moulding machine	<input checked="" type="checkbox"/> Vertical Group <input checked="" type="checkbox"/> Horizontal Committee.....		25/08/2009 02/06/1999
Question related to: Directive 2006/42/EC Annex: I ESR (1): 1.3.7		To be endorsed by: <input checked="" type="checkbox"/> Standing Committee..... EN 289 :1994, EN 201: 1997 Other: Clause: [(pr)EN] 6.2 / 6.3 / none CEN TC concerned :	
Key words: Vertical Injection or Compression Moulding Machine Response-time of the hydraulic system			
Question: Is a manufacturer of a injection or compression moulding machine equipped with a light curtain or a two-hand control obliged to install an automatically working response-time-measurement system?			
Solution: - No, In the C-standards EN 289 and EN 201 is no indication to do so. The manufacturer has to give information on the values of the response time and the corresponding distances in the user's manual. In addition, the manufacturer shall give the following information in the user's manual : - maximum closing speed, - maximum dimension of the mould, - information about the necessity of nw evaluation of safety distances and response time after repair or adjustment.			
Adaptation procedure: FORMAL ADAPTATION IN CONFORMITY WITH DIRECTIVE 2006/42/EC			

(1) Essential safety requirement

Note: According to point 6.6 of the Guide of the implementation of directives based on the New Approach and the Global Approach, the notified bodies apply as general guidance this recommendation for use.

	CO-ORDINATION OF NOTIFIED BODIES Machinery Directive 2006/42/CE + Amendment RECOMMENDATION FOR USE		CNB/M/04.034 Revision: 05 Language: E
Date of first stage: 02/12/1999	To be approved by:		Approved on:
Origin: VG4 Injection or compression moulding machine	<input checked="" type="checkbox"/> Vertical Group <input checked="" type="checkbox"/> Horizontal Committee	25/08/2009 02/12/1999	
		To be endorsed by:	Endorsed on:
		<input checked="" type="checkbox"/> Machinery Working Group.....	09/04/2001
Question related to: Directive 2006/42/EC Annex: I ESR (1): 1.4.2.2	EN/prEN: EN 201:1997 Clause: [(pr)EN]: 5.2.2 CEN TC concerned :	Other:	
Key words: Rubber and Plastics injection moulding machine; interlocking of movable guards providing access to the closing mechanism area			
<p>Question:</p> <p>What are the possible solutions for electrical interlock of movable guards of the closing mechanism other than the standard EN 201 requires?</p> <p>Solution:</p> <p>a) 1 limit switch operated by a roller level (pos. 1) and 1 tongue switch with separate actuator (pos.2). Pos. 1 is actuated when the guard gate is closed; in pos. 2, the actuator is inserted into the switch when the guard gate is closed. Pos. 2 shall be provided with a coded actuator or a time monitoring shall be provided in such a way that the cycle is interrupted when the actuation is not simultaneous.</p> <p>b) 2 coded togue switches with separate actuators; when the guard gate is closed, both actuators are inserted into the switch.</p> <p>c) If none coded switches are used time monitoring shall be provided in such a way that the cycle is interrupted when the actuation is not simultaneous. The two switches shall be positioned in such a way, that they can not be actuated simultaneously by one person.</p> <p>Adaptation procedure: FORMAL ADAPTATION IN CONFORMITY WITH DIRECTIVE 2006/42/EC</p>			

(1) Essential safety requirement

Note: According to point 6.6 of the Guide of the implementation of directives based on the New Approach and the Global Approach, the notified bodies apply as general guidance this recommendation for use.

	CO-ORDINATION OF NOTIFIED BODIES Machinery Directive 2006/42/CE + Amendment RECOMMENDATION FOR USE	CNB/M/04.038 Revision: 05 Language: E
Date of first stage: 19/01/2001 Origin: VG4 Injection or compression moulding machine	To be approved by: <input checked="" type="checkbox"/> Vertical Group <input checked="" type="checkbox"/> Horizontal Committee..... To be endorsed by: <input checked="" type="checkbox"/> Working Group Machinery	Approved on: 26/08/2009 07/12/2000 Endorsed on: 04/01/2005
Question related to : Directive 2006/42/EC Annex: I ESR (1): 1.3.8.2.	EN/prEN: EN 201:1997 Clause: [(pr)EN] none CEN TC concerned :	Other :
Key words: Injection moulding machines for rubber; laser scanners		
Question: In which conditions can the mould area of an injection moulding machine for rubber be protected by laser scanners?		
Solution: <ul style="list-style-type: none"> • At this moment, it is impossible to protect the mould area by using only one laser scanner because this component only fulfills the requirements of the category 3 of EN 954-1:1996. • For specific applications (particular process) 2 laser scanners could be used on the side of the machine from which the start cycle command may be given. All of the following requirements shall be met: <ul style="list-style-type: none"> ⇒ The laser scanners are category 3 according to EN 954-1:1996. ⇒ The distances given by EN 999:1998 are met. ⇒ The laser scanners are arranged in such a way that the beams are parallel at different levels (one beam lower than 400 mm and second beam not higher than 900 mm). ⇒ Information coming from each laser scanner is monitored in such a way that a fault occurring on one of the systems prevents starting a new cycle after interruption. ⇒ See also sheet CNB/M/04.011/R/E/Rev.03 for switch off conditions. In addition to that, information shall be given in the instruction manual. <ul style="list-style-type: none"> • Instruction relating to the marking of the protected area, • Instruction relating to the testing procedure for the protective devices, • Instruction relating to the programming of the protected area. <p>Adaptation procedure: FORMAL ADAPTATION IN CONFORMITY WITH DIRECTIVE 2006/42/EC</p>		

(1) Essential safety requirement

Note: According to point 6.6 of the Guide of the implementation of directives based on the New Approach and the Global Approach, the notified bodies apply as general guidance this recommendation for use.

	CO-ORDINATION OF NOTIFIED BODIES Machinery Directive 2006/42/CE + Amendment RECOMMENDATION FOR USE		CNB/M/04.039 Revision: 05 Language : E
Date of first stage:19/01/2001		To be approved by :	Approved on :
Origin : VG4 Injection or compression moulding machine		<input checked="" type="checkbox"/> Vertical Group <input checked="" type="checkbox"/> Horizontal Committee..... To be endorsed by: <input checked="" type="checkbox"/> Machinery Working Group	26/08/2009 07/12/2000 Endorsed on : 04/01/2005
Question related to: Directive 2006/42/EC Annex: I ESR (1): 1.3.7		EN/prEN: EN 201 : 1997 Clause: [(pr)EN] 5.3.1, 5.3.2 CEN TC concerned:	Other:
Key words: Rubber and Plastics injection moulding machines / Accessible mould area / Pressure-sensitive platforms in the mould area			
Question: Under which requirements sensitive platforms may replace the pressure sensitive mats or floors specified in clauses 5.3.1 and 5.3.2 of EN 201:1997?			
Solution: Yes, under the following conditions: The limit switches shall act by hardware acc. to EN 201:1997, cl. 5.3.2 and 5.3.1. Where the limit switch signals act on relays , these relays shall be redundant and monitored. Testing and monitoring of each individual limit switch is not required. The limit switches shall have positive opening operation and shall be positively and directly actuated by the platform. Testing: After each machine start-up (main switch on), the testing shall be effected in such a way after the mould area guard has been opened for the first time that a new cycle can be initiated only after the correct working of the platform switches have been tested e.g. by stepping upon the platform or actuating a limit switch. The instruction for use shall contain a requirement that the machine user shall check the correct output signal of the platform at defined places (at least once a month). Adaptation procedure: FORMAL ADAPTATION IN CONFORMITY WITH DIRECTIVE 2006/42/EC			

(1) Essential safety requirement

Note: According to point 6.6 of the Guide of the implementation of directives based on the New Approach and the Global Approach, the notified bodies apply as general guidance this recommendation for use.

	CO-ORDINATION OF NOTIFIED BODIES Machinery Directive 2006/42/CE + Amendment RECOMMENDATION FOR USE	CNB/M/04.040 Revision: 05 Language: E
Date of first stage: 02/12/1999	To be approved by :	Approved on:
Origin: VG4 Injection or compression moulding machine	<input checked="" type="checkbox"/> Vertical Group <input checked="" type="checkbox"/> Horizontal Committee..... To be endorsed by: <input checked="" type="checkbox"/> Machinery Working Group	26/08/2009 02/12/1999 Endorsed on: 09/04/2001
Question related to: Directive 2006/42/EC Annex: I ESR (1): 1.4.2.2	EN/prEN: EN 201:1997 Clause: [(pr)EN] 5.3.2 CE TC concerned:	Other:
Key words: Injection moulding machines; automatic sequence control, guard closing; latch retracting, mould closing. Machines tie bar distance > 1200 mm		
Question: Which sequence regarding guard closing - retracting the latch - mould closing shall be provided (sequence, kind of actuating device) for machines having a tie bar distance exceeding 1200 mm?		
Solution: Principally, EN 201:1997 provides the following sequence: 1. separate retracting of the latch, i.e. actuation of a control device 2. guard closing by actuating a further control device here: hold-to-run control device 3. After closing of a guard a further, third control device shall be actuated for closing the mould, as otherwise this would be a gate start in acc. With clause 5.2.1.1.4. The notified bodies are of the opinion that it is not necessary to push 3 different command devices in sequence. As an alternative, the sequence can be organised as follows: 1.1 A hold-to-run control device ensures latch retraction and guard closing. As soon as the guard is closed, a further control device shall be actuated that initiates the mould closing. <u>or</u> 1.2 The actuation of the control device ensures latch retraction. Within 3 seconds after release of this control device a further control device shall be actuated for guard closing (hold-to-run). If this command device is released and actuated again after the door is closed, the closing of the mould shall be initiated. The command device has to be monitored at each cycle of the movable guard. Adaptation procedure: FORMAL ADAPTATION IN CONFORMITY WITH DIRECTIVE 2006/42/EC		

(1) Essential safety requirement

Note: According to point 6.6 of the Guide of the implementation of directives based on the New Approach and the Global Approach, the notified bodies apply as general guidance this recommendation for use.

	CO-ORDINATION OF NOTIFIED BODIES MACHINERY DIRECTIVE 2006/42/EC + Amendment RECOMMENDATION FOR USE	CNB/M/04.041 Revision: 08 Language: E
Date of first stage: 19/03/2001 Origin: VG4 Injection or compression moulding machine	To be approved by: <input checked="" type="checkbox"/> Vertical Group <input type="checkbox"/> Horizontal Committee..... To be endorsed by: <input checked="" type="checkbox"/> Machinery Working Group...	Approved on: 26/08/2009 Endorsed on: 07/11/2006
Question related to: Dir. 2006/42/EC Article: Annex: I EHSR (1): 1.4.2.2	EN/prEN: EN 201:1997 Normative clause: 5, 6.1 CEN TC concerned: TC 145 WG1	Other: EN 289:2004 Other clause: Annex B
Key words: Injection and compression moulding machines for rubber and plastics-proximity switches for safeguarding		
Question: 1. Is it possible to replace the 2 mechanical switches according to type II by one proximity switch? 2. What are the consequences for type III?		
Answer: 1. Yes, under the following conditions: <ul style="list-style-type: none"> - The proximity switch and its corresponding control unit are conform to category 3 (EN 954-1:1996), tested and certified by a recognized third party - The matching part of the proximity switch shall be individually coded - The matching part of the switch is fixed on the movable guard in a way that it cannot be defeated in an easy way (this part should be riveted, covered or fixed one-way-screws etc.) - The two position switches (see fig. 7 of EN 201:1997, type II) which act on the main shut off device of the power circuit may be replaced by a single proximity switch. 2. The same solution as defined above could also be applied in the type III interlocking system for those 2 switches that act on the main shut off device. Adaptation procedure: FORMAL ADAPTATION IN CONFORMITY WITH DIRECTIVE 2006/42/EC		

(1) Essential health and safety requirement

Note: According to point 6.6 of the Guide of the implementation of directives based on the New Approach and the Global Approach, the notified bodies apply as general guidance this recommendation for use.

	<p>CO-ORDINATION OF NOTIFIED BODIES Machinery Directive 2006/42/CE + Amendment</p> <p>RECOMMENDATION FOR USE</p>	<p>CNB/M/04.043 Revision: 04 Language: E</p>
<p>Date of first stage: 19/01/2001</p> <p>Origin: VG4 Injection or compression moulding machine</p>	<p>To be approved by:</p> <p><input checked="" type="checkbox"/> Vertical Group</p> <p><input checked="" type="checkbox"/> Horizontal Committee.....</p> <p>To be endorsed by:</p> <p><input checked="" type="checkbox"/> Machinery Working Group ...</p>	<p>Approved on:</p> <p>26/08/2009</p> <p>07/12/2000</p> <p>Endorsed on :</p> <p>04/01/2005</p>
<p>Question related to: Directive 2006/42/EC</p> <p>Annex: I ESR (1): 1.3.7, 1.4.1</p>	<p>EN/prEN: EN 201:1997</p> <p>Clause: [(pr)EN] 5.2.1.1.1</p> <p>CEN TC concerned :</p>	<p>Other: CNB/M/04.026</p>
<p>Key words: Horizontal moulding machines / Safety distances / Shape of the guard</p>		
<p>Question:</p> <p>How to take into account the shape of the guard when applying EN 294:1992 / table 1 (specification of CNB/M/04.026)</p>		
<p>Solution:</p> <p>See page 2</p>		
<p>Adaptation procedure: FORMAL ADAPTATION IN CONFORMITY WITH DIRECTIVE 2006/42/EC.</p>		

(1) Essential safety requirement
 Note: According to point 6.6 of the Guide of the implementation of directives based on the New Approach and the Global Approach, the notified bodies apply as general guidance this recommendation for use.

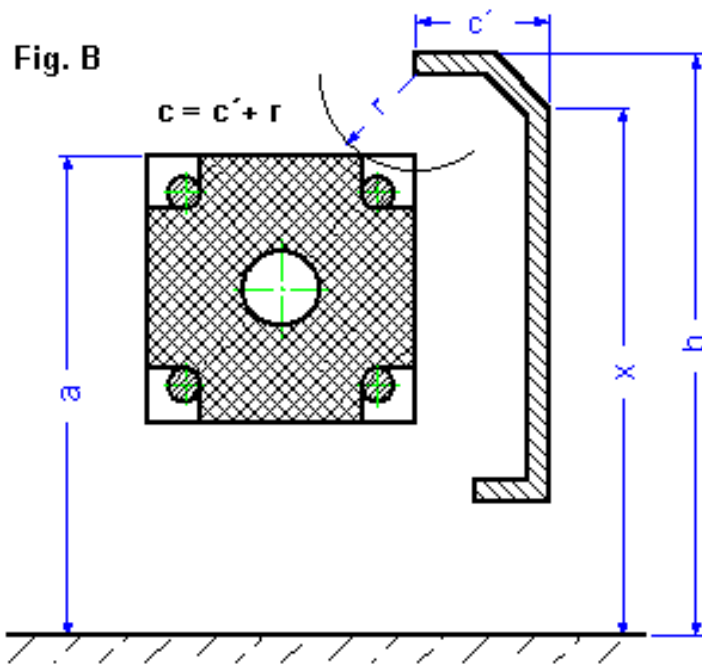
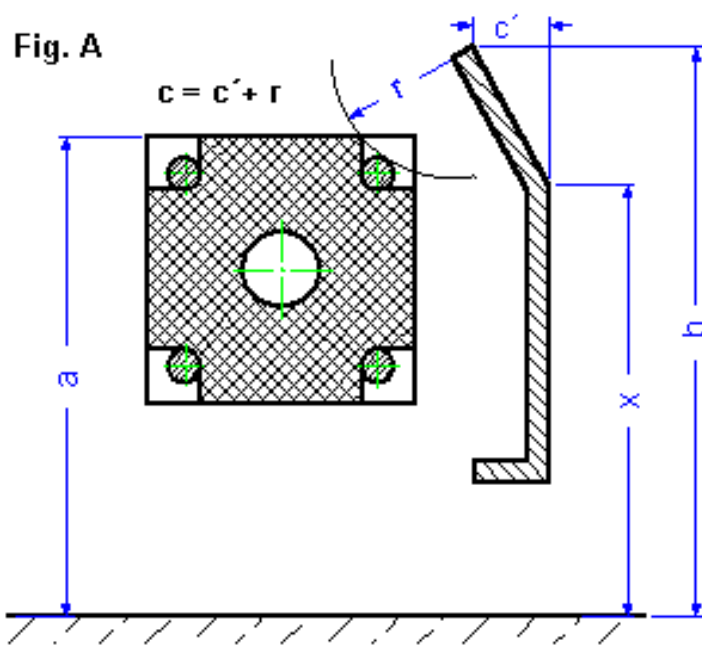

Additional condition for both figures: $x \geq 1600$ mm

	<p>CO-ORDINATION OF NOTIFIED BODIES Machinery Directive 2006/42/CE + Amendment</p> <p>RECOMMENDATION FOR USE</p>		<p>CNB/M/04.044 Revision: 04 Language: E</p>
Date of first stage: 19/01/2001	To be approved by:		Approved on:
Origin: VG4 Injection or compression moulding machine	<input checked="" type="checkbox"/> Vertical Group <input checked="" type="checkbox"/> Horizontal Committee.....		<p>26/08/2009 07/12/2000</p>
<p>Question related to: Directive 2006/42/EC</p> <p>Annex: V 3 a) ESR (1):</p>	<p>EN/prEN: EN 201:1997</p> <p>Clause: [(pr)EN] 7.1</p> <p>CEN TC concerned:</p>		Other:
Key words: Rubber and Plastics injection moulding machines / Risk analysis in the technical file			
<p>Question:</p> <p>Does the machine manufacturer have to incorporate a detailed risk analysis for all risks occurring at the injection moulding machine into the technical file?</p>			
<p>Solution:</p> <p>No, the machine manufacturer shall incorporate an information into the technical file, saying that design and construction of the injection moulding machine fulfil the risks and measures listed in the harmonized standards EN 201/EN 289.</p> <p>Only for those machines or parts of the machine where harmonized standards (EN 201:1997)) do not describe risks and measures (e.g. additional fitting of handling devices, use of special protective devices, etc.), the additional risks shall be listed and the measures taken to eliminate these risks shall be described.</p> <p>Adaptation procedure: FORMAL ADAPTATION IN CONFORMITY WITH DIRECTIVE 2006/42/EC</p>			

(1) Essential safety requirement

Note: According to point 6.6 of the Guide of the implementation of directives based on the New Approach and the Global Approach, the notified bodies apply as general guidance this recommendation for use.

	CO-ORDINATION OF NOTIFIED BODIES Machinery Directive 2006/42/CE + Amendment RECOMMENDATION FOR USE	CNB/M/04.051 Revision: 04 Language: E
Date of first stage: 19/01/2001	To be approved by:	Approved on:
Origin: VG4 Injection or compression moulding machine	<input checked="" type="checkbox"/> Vertical Group	26/08/2009
	<input checked="" type="checkbox"/> Horizontal Committee.....	07/12/2000
	To be endorsed by:	Endorsed on :
	<input checked="" type="checkbox"/> Machinery Working Group...	04/01/2005
Question related to: Directive 2006/42/EC Annex: I ESR (1): 1.2.1	EN/prEN: EN 201:1997 Clause: [(pr)EN] Annex A CEN TC concerned:	Other:
Key words: Rubber and Plastics injection moulding machines / Monitoring by a programmable controller		
Question : What has the notified body to check when the monitoring of the safety functions is effected by a programmable controller?		
Solution : In addition to the requirements detailed in annex A of EN 201:1997, the notified body has to check: <ul style="list-style-type: none">- how the specific part of the software is organized- how the application software integrates the specific part- how the manufacturer can ensure that the specific part of the software is complete (by using a checksum for example)- how the manufacturer has ensured that the user is not able to change the safety-related parts of the software		
Adaptation procedure: FORMAL ADAPTATION IN CONFORMITY WITH DIRECTIVE 2006/42/EC		

(1) Essential safety requirement

Note: According to point 6.6 of the Guide of the implementation of directives based on the New Approach and the Global Approach, the notified bodies apply as general guidance this recommendation for use.

	<p>CO-ORDINATION OF NOTIFIED BODIES Machinery Directive 2006/42/CE + Amendment</p> <p>RECOMMENDATION FOR USE</p>	<p>CNB/M/04.052 Revision: 04 Language: E</p>
<p>Date of first stage: 19/01/2001</p> <hr/> <p>Origin : VG4 Injection or compression moulding machine</p>	<p style="text-align: center;">To be approved by:</p> <p><input checked="" type="checkbox"/> Vertical Group</p> <p><input checked="" type="checkbox"/> Horizontal Committee</p> <p style="text-align: center;">To be endorsed by:</p> <p><input checked="" type="checkbox"/> Machinery Working Group.....</p>	<p style="text-align: center;">Approved on:</p> <p style="text-align: right;">26/08/2009 07/12/2000</p> <p style="text-align: center;">Endorsed on:</p> <p style="text-align: right;">04/01/2005</p>
<p>Question related to: Directive 2006/42/EC</p> <p>Annex: I ESR (1): 1.4.2.2</p>	<p>EN/prEN: EN 201:1997 Other:</p> <p>Clause: [(pr)EN] 5</p> <p>CEN TC concerned:</p>	
<p>Key words: Rubber and Plastics injection moulding machines / Interlocking of movable guards that give access to the mould area</p>		
<p>Question:</p> <p>Is it possible to use key switches to interlock guards that give access to the mould area?</p> <p>NOTE: A key switch has a separate actuator.</p>		
<p>Solution:</p> <p>Yes, if all the following requirements are met:</p> <ul style="list-style-type: none"> - one key switch can only replace one limit switch - when the guard is closed, all the keys are inserted into the corresponding switch - keys are fixed on the movable guard in a way that they cannot be removed in an easy way (fixing by rivets, one way screws for example) - at least one of the switches should be positioned in such a way that it is impossible to insert the key when the guard is open - a time monitoring is provided in such a way that it is impossible to start the cycle if the actuation of the switches is not simultaneous (about 0,5 s) <p style="text-align: center;">Adaptation procedure: FORMAL ADAPTATION IN CONFORMITY WITH DIRECTIVE 2006/42/EC</p>		

(1) Essential safety requirement

Note: According to point 6.6 of the Guide of the implementation of directives based on the New Approach and the Global Approach, the notified bodies apply as general guidance this recommendation for use.

	CO-ORDINATION OF NOTIFIED BODIES Machinery Directive 2006/42/CE + Amendment RECOMMENDATION FOR USE	CNB/M/04.053 Revision: 04 Language: E
Date of first stage: 20/03/2001	To be approved by:	Approved on:
Origin: VG4 Injection or compression moulding machine	<input checked="" type="checkbox"/> Vertical Group <input checked="" type="checkbox"/> Horizontal Committee..... To be endorsed by: <input checked="" type="checkbox"/> Machinery Working Group	26/08/2009 19/06/2001 Endorsed on : 04/01/2005
Question related to: Directive 2006/42/EC Annex: I ESR (1):	EN/prEN: EN 201:1997 Clause: general CEN TC concerned:	Other:
Key words: 24 VDC hydraulic valves, protective bonding circuit connection on the voltage supply plug of a 24 VDC solenoid valve		
Question: Is it necessary to have a separate grounding wire to each 24 VDC solenoid valve?		
Solution: It is not necessary to have a separate grounding wire to each solenoid valve if the following conditions are fulfilled : <ul style="list-style-type: none"> - coils are supplied by separate winding transformer or equivalent - the coil of solenoid is coated in an insulating material - one side of the secondary output is connected to earth - the connector is made of plastic - an interconnection has to be done between the frame and the block supporting the valves either by wiring or by fixing the valves on the frame Adaptation procedure: FORMAL ADAPTATION IN CONFORMITY WITH DIRECTIVE 2006/42/EC		

(1) Essential safety requirement
 Note: According to point 6.6 of the Guide of the implementation of directives based on the New Approach and the Global Approach, the notified bodies apply as general guidance this recommendation for use.

	CO-ORDINATION OF NOTIFIED BODIES MACHINERY DIRECTIVE 2006/42/EC + Amendment RECOMMENDATION FOR USE	CNB/M/04.064 Revision: 05 Language: E
Date of first stage: 16/12/2003 Origin : VG4 Injection or compression moulding machine	To be approved by: <input checked="" type="checkbox"/> Vertical Group <input checked="" type="checkbox"/> Horizontal Committee..... To be endorsed by : <input checked="" type="checkbox"/> Machinery Working Group	Approved on: 26/08/2009 09/12/2004 Endorsed on : 24/05/2005
Question related to: Dir. 2006/42/EC Article: Annex: I EHSR (1): 1.2.4.3	EN/prEN : EN 201:1997 Normative clause: 5, 5.2.5.3 CEN TC concerned: TC 145	Other : EN 418:1992, EN 60204-1:1997 Other clause: Annex D
Key words: Injection moulding machine for plastics – Emergency stop, heating elements		
Question: Shall the emergency stop disconnect the energy supply to the heating elements?		
Answer: No, because the disconnection of energy supply to the heating elements will not immediately reduce the temperature risk. In addition, the drop of temperature could create new risks during a restart due to partly frozen material. The next heating up of the cold material could create the risk of ejection. A warning in the instruction manual shall advise the operator about the function of the emergency stop. Especially, it shall be mentioned that in case of emergency stop the heating is not switched off. Adaptation procedure: FORMAL ADAPTATION IN CONFORMITY WITH DIRECTIVE 2006/42/EC		

(1) Essential health and safety requirement

Note: According to point 6.6 of the Guide of the implementation of directives based on the New Approach and the Global Approach, the notified bodies apply as general guidance this recommendation for use.

	CO-ORDINATION OF NOTIFIED BODIES MACHINERY DIRECTIVE 2006/42/EC + Amendment RECOMMENDATION FOR USE		CNB/M/04.069 Revision: 06 Language: E
Date of first stage: 16/09/2005 Origin: VG4 Injection or compression moulding machine	To be approved by: <input checked="" type="checkbox"/> Vertical Group <input checked="" type="checkbox"/> Horizontal Committee..... To be endorsed by: <input checked="" type="checkbox"/> Machinery Working Group..	Approved on: 26/08/2009 10/06/2008 Endorsed on: 08/01/2009	
Question related to : Dir. 2006/42/EC Article : Annex: I EHSR (1): 1.4.2.2	EN/prEN : EN 201: 1997 Other: EN 954-1:1996 Normative clause: 5 Other clause : CEN TC concerned: TC 145		
Key words: Injection moulding machines – Protection device type III			
Question: Is it possible to replace the 3 switches and the corresponding machine control circuit of an injection moulding machine as defined for type III by a system using a proximity switch and its relevant control unit independently of the power source (hydraulic or electrical drive) of the injection moulding machine ?			
Answer : Yes, under the following conditions: <ul style="list-style-type: none"> ✚ The proximity switch and its control unit fulfil the requirements of EN 954-1:1996, category 4, and EN 60947-5-3:1999 + A1:2005, PDF-M, tested and certified by a recognized third party (PDF_M stands for Proximity Device with defined behaviour under Fault conditions with self-Monitoring, this ensures that a single fault does not lead to a loss of the safety function and that the fault is detected). ✚ The proximity switch is connected to its control unit according to the requirements of the manufacturer of the switch and its control unit for this category ✚ The counterpart and the proximity switch shall be individually coded. If the counterpart is changed to a similar one, the control system of the machine shall prevent any further movement. The counterpart shall be fastened to the guard door by particular non-detachable fastening elements the design of which shall conform to EN 1088:1995/ A1:2007/clause 5.7.3 If one of these requirements is not fulfilled, a cyclic monitoring at least once during each cycle of the machine for manual operated guards or at each cycle of the guard for a power operated guard is done in any operational mode to verify that the moving part of the switching unit is not attached to the other part permanently. A negative test result shall lead to a prevention of further stroke initiation. The cyclic test can be done e.g. by a standard PLC. ✚ The two shut-off devices are driven by two separate channels of the control unit of the proximity switch. Monitoring of the two shut-off devices shall be achieved by the control unit of the proximity switch or by the control system of the machine. <p>NOTE: Individually coded means that it is unlikely to find another matching part that can be used to defeat the protective system. Individually coded does not require a unique pair combination of switch and counterpart.</p> <h2>Adaptation procedure: FORMAL ADAPTATION IN CONFORMITY WITH DIRECTIVE 2006/42/EC</h2>			

(1) Essential health and safety requirement

Note: According to point 6.6 of the Guide of the implementation of directives based on the New Approach and the Global Approach, the notified bodies apply as general guidance this recommendation for use.

	CO-ORDINATION OF NOTIFIED BODIES Machinery Directive 2006/42/EC + Amendment RECOMMENDATION FOR USE		CNB/M/04.073 Revision 05 Language: E
Date of first stage: 20/06//2007 Origin: VG4 Injection or compression moulding machine	To be approved by: <input checked="" type="checkbox"/> Vertical Group..... <input checked="" type="checkbox"/> Horizontal Committee..... To be endorsed by: <input checked="" type="checkbox"/> Machinery Working Group.....	Approved on: 26/08/2009 10/06/2008 Endorsed on: 08/01/2009	
Question related to : Dir. 2006/42/EC Article: Annex: I EHSR (1): 1.2.1, 1.2.6	EN/prEN: EN 289: 2004 Normative clause: 5.2.1 CEN TC concerned: TC145 WG1	Other: Other clause:	
Key words: Plastics and rubber machines – compression moulding machines – mechanical restraint device			
Question: For compression moulding machines with two hydraulic restraint valves, clause 5.4.1.1.3 requires an additional mechanical restraint device which shall block the upper platen in its maximum upper position automatically. How is the maximum upper position defined?			
Recommended solution: The maximum upper position is the maximum physically reachable position During normal production the platen relies on a redundant and monitored hydraulic system. For operations like e.g. maintenance of setting it is necessary to block the press by the mechanical restraint device. This is to be done with the platen resting in the max. upper position and the mechanical restraint device being activated automatically in this position. NOTE: In order to release the mechanical restraint device, a small amount of further upper movement will be necessary.			
Adaptation procedure: FORMAL ADAPTATION IN CONFORMITY WITH DIRECTIVE 2006/42/EC			

(1) Essential health and safety requirement
 Note: According to point 6.6 of the Guide of the implementation of directives based on the New Approach and the Global Approach, the notified bodies apply as general guidance this recommendation for use.

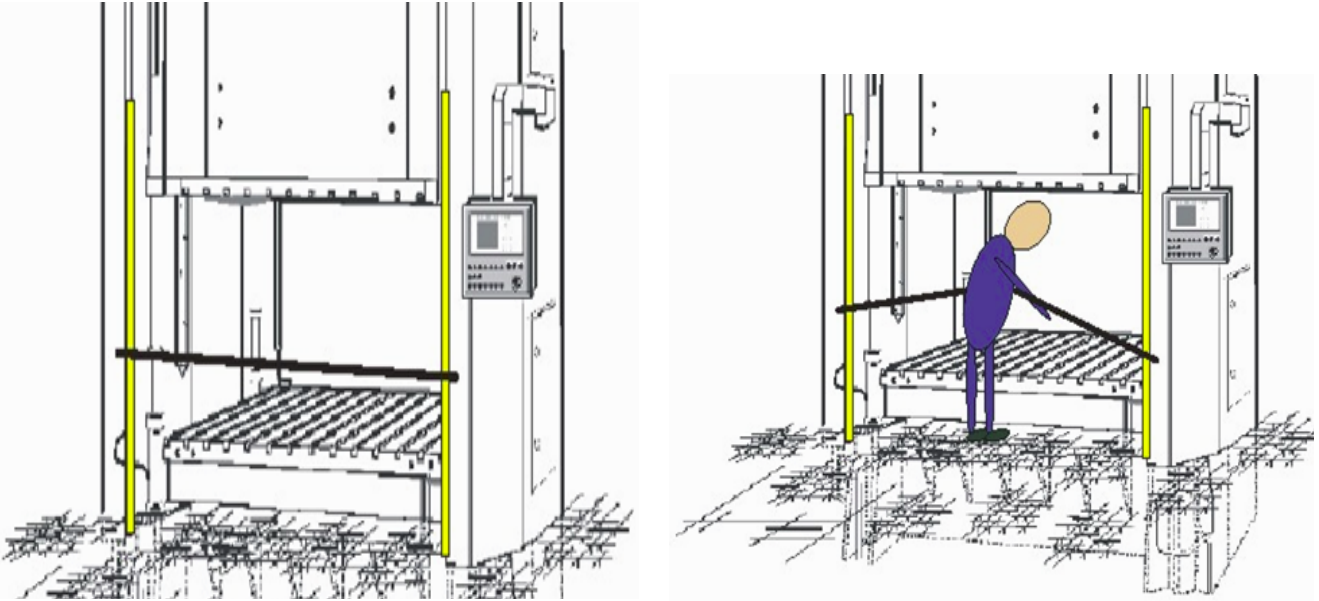
	<p>CO-ORDINATION OF NOTIFIED BODIES Machinery Directive 2006/42/EC + Amendment</p> <p>RECOMMENDATION FOR USE</p>	<p>CNB/M/04.075 Revision 04 Language: E</p>
<p>Date of first stage: 11/12/2006</p> <p>Origin: VG4 Injection or compression moulding machine</p>	<p>To be approved by:</p> <p><input checked="" type="checkbox"/> Vertical Group.....</p> <p><input checked="" type="checkbox"/> Horizontal Committee.....</p> <p>To be endorsed by:</p> <p><input checked="" type="checkbox"/> Machinery Working Group.....</p>	<p>Approved on:</p> <p>26/08/2009 10/06/2008</p> <p>Endorsed on:</p> <p>08/01/2009</p>
<p>Question related to : Dir. 2006/42/EC Article:</p> <p>Annex: I EHSR (1): 1.4.3</p>	<p>EN/prEN: EN 289: 2004</p> <p>Normative clause: 5.5.2.3 & 5.2.3</p> <p>CEN TC concerned: TC 145 WG 2</p>	<p>Other:</p> <p>Other clause:</p>
<p>Key words: Plastics and rubber machines – compression moulding machines – detection of persons standing behind a light curtain within the tool area</p>		
<p>Question:</p> <p>For a press which is safeguarded by a light curtain with a lower platen in a height less than 750 mm above the operator's level clause 5.5.2.3 of EN 289 requires means to detect persons staying within the tools area.</p> <p>Is a solution acceptable, which detects a person entering the dangerous zone e.g. by means of a tape which is stretched towards the dangerous area when this area is entered?</p> <p>Note: When entering the dangerous zone the person will stretch the tape. Stretching of the tape or loss of the tape will be detected by the control system according to the requirements of category 2 of EN 954-1.</p>		
<p>Recommended solution:</p> <p>No, a solution to detect the presence of a person within the dangerous area (e.g. as shown in the figures below) only detects, that the dangerous area is entered as long as the tape is stretched. If a user bypasses the tape and enters the dangerous zone his presence in the dangerous area will not be detected.</p> <p>Because of this device being easily bypassed it is not acceptable as an additional protective device as required in 5.5.2.3.</p>		
		
<p>Adaptation procedure: FORMAL ADAPTATION IN CONFORMITY WITH DIRECTIVE 2006/42/EC</p>		

(1) Essential health and safety requirement

Note: According to point 6.6 of the Guide of the implementation of directives based on the New Approach and the Global Approach, the notified bodies apply as general guidance this recommendation for use.

	CO-ORDINATION OF NOTIFIED BODIES Machinery Directive 2006/42/EC + Amendment RECOMMENDATION FOR USE		CNB/M/04.076 Revision 03 Language: E
Date of first stage: 13/11/2008	To be approved by:		Approved on:
Origin: VG4 Injection or compression moulding machine	<input checked="" type="checkbox"/> Vertical Group..... <input checked="" type="checkbox"/> Horizontal Committee.....		26/08/2009 09/12/2008
	To be endorsed by:		Endorsed on:
	<input checked="" type="checkbox"/> Machinery Working Group.....		18/06/2009
Question related to : Dir. 2006/42/EC	Article:	EN/prEN: EN 201 :1997	Other: prEN 201:2008
Annex: I	EHSR (1): 1.2.7	Normative clause: 5.2.1	Other clause: 5.2.1 Annex C
CEN TC concerned: TC 145			
Key words: Plastics and rubber hydraulic IMM – horizontal mould closing movement – motor control unit			
Question:			
The pump of the hydraulic circuit is driven by an electrical motor and its control unit (frequency converter or contactor).			
Is it possible to use as second shut-off device, defined in EN 201 type III, a motor control unit, a frequency converter or a contactor that switches-off the pump drive (the main power source for the horizontal closing movement of the platen) instead of a valve?			
Recommended solution:			
Yes, provided that:			
<ul style="list-style-type: none"> • The opening of the guard shall activate the Safe Torque Off function (see definition in EN 61800-5-2:2007) of the motor control unit or switch-off the contactor. 			
<ul style="list-style-type: none"> • The motor control unit Safe Torque Off function shall comply with the requirements of PL c, category 2 or 3 of EN ISO 13849-1:2006, and shall be tested by an independent laboratory complying with EN ISO/IEC 17025. 			
<ul style="list-style-type: none"> • The contactor shall be directly connected to the motor and with linked or mirror control contacts. 			
<ul style="list-style-type: none"> • The change of the signal of the switch-off coming from the motor control unit or the contactor shall be automatically monitored at least once during each cycle of the movable guard. 			
<ul style="list-style-type: none"> • Commencement of any further cycle after closing of the movable guard shall be possible only if no faults have been detected. 			
<ul style="list-style-type: none"> • The fault of the main shut-off device shall not create a dangerous run-down. 			
<ul style="list-style-type: none"> • The only power source for the closing movement of the movable platen shall be the pump; no accumulators shall be installed on this line. 			
Adaptation procedure: FORMAL ADAPTATION IN CONFORMITY WITH DIRECTIVE 2006/42/EC			

(1) Essential health and safety requirement

Note: According to point 6.6 of the Guide of the implementation of directives based on the New Approach and the Global Approach, the notified bodies apply as general guidance this recommendation for use.

	CO-ORDINATION OF NOTIFIED BODIES Machinery Directive 2006/42/EC + Amendment RECOMMENDATION FOR USE		CNB/M/04.077 Revision 03 Language: E
Date of first stage: 13/11/2008	To be approved by:		Approved on:
Origin: VG4 Injection or compression moulding machine	<input checked="" type="checkbox"/> Vertical Group..... <input checked="" type="checkbox"/> Horizontal Committee.....		26/08/2009 09/12/2008
		To be endorsed by:	Endorsed on:
		<input checked="" type="checkbox"/> Machinery Working Group....	18/06/2009
Question related to: Dir. 2006/42/EC	Article:	EN/prEN: EN 201: 1997	Other: prEN 201: 2008
Annex: I	EHSR (1): 1.2.7	Normative clause: 5.2.1	Other clause: 5.2.1
Key words: Plastics and rubber horizontal IMM – two platens machine – high pressure mould closing movement			
Question: On two platens hydraulic horizontal IMMs it is possible to have a low pressure circuit for the high speed approach of the moulds and a circuit for the slow speed, high pressure closing movement. Is it acceptable to adopt an EN 201 type II protection in order to prevent the high pressure closing movement of the mould when a movable guard of the mould area is open?			
Recommended solution: One possible solution is the following: <ul style="list-style-type: none"> • The control circuit of the machine shall detect and record automatically the mould height. • The high pressure mould closing movement of the movable platen shall be permitted only when the mould is nearly closed. • The maximum high pressure closing stroke of the movable platen shall be less than or equal to 6 mm. If this value is exceeded the closing movement shall be interrupted and a new mould height setting is necessary in order to allow a new high pressure closing movement. NOTE Additionally in case of a failure of the system a production cycle cannot be executed.			
Adaptation procedure: FORMAL ADAPTATION IN CONFORMITY WITH DIRECTIVE 2006/42/EC			

(1) Essential health and safety requirement

Note: According to point 6.6 of the Guide of the implementation of directives based on the New Approach and the Global Approach, the notified bodies apply as general guidance this recommendation for use.

	CO-ORDINATION OF NOTIFIED BODIES Machinery Directive 2006/42/EC + Amendment RECOMMENDATION FOR USE		CNB/M/04.078 Revision 03 Language: EN
Date of first stage: 14/11/2008	To be approved by:	Approved on:	
Origin: VG4 Injection or compression moulding machine	<input checked="" type="checkbox"/> Vertical Group.....	26/08/2009	
	<input checked="" type="checkbox"/> Horizontal Committee.....	09/12/2008	
	To be endorsed by:	Endorsed on:	
	<input checked="" type="checkbox"/> Machinery Working Group....	18/06/2009	
Question related to : Dir. 2006/42/EC Article:	EN/prEN : EN 201: 1997	Other:	
Annex: I EHSR (1): 1.5.5	Normative clause: 5.2.5.2	Other clause:	
	CEN TC concerned: 145		
Key words: Plastic and rubber IMM - plasticizing unit – measurement of the temperature on the surface of the cover of the plasticizing unit			
Question:			
Is it allowed to neglect the influence of ambient temperature and humidity when measuring the temperature on the surface of the cover of the plasticizing unit?			
Recommended solution:			
Yes because in the EN ISO 13732-1:2006 there are no requirements that these influences have to be considered.			
<h3>Adaptation procedure: FORMAL ADAPTATION IN CONFORMITY WITH DIRECTIVE 2006/42/EC</h3>			

(1) Essential health and safety requirement
 Note: According to point 6.6 of the Guide of the implementation of directives based on the New Approach and the Global Approach, the notified bodies apply as general guidance this recommendation for use.

	CO-ORDINATION OF NOTIFIED BODIES Machinery Directive 2006/42/EC + Amendment RECOMMENDATION FOR USE	CNB/M/04.083 Revision 04 Language: E
Date of first stage: 28/07/2011	To be approved by:	
Origin: VG4 Injection or compression moulding machine	<input checked="" type="checkbox"/> Vertical Group <input checked="" type="checkbox"/> Horizontal Committee	Approved on: 13/09/2011 13/12/2011
		To be endorsed by: <input checked="" type="checkbox"/> Machinery Working Group....
Question related to: Directive 2006/42/EC	Article:	EN/prEN: EN 201: 2009
Annex: I	ESR (1): 1.5.14	Other: Other clause: 5.10.4
		Clause: 5.2.7, 5.2.8 CEN TC concerned: TC 145 WG1
Key words: injection machines with tie bar distances >1200 mm; person standing behind the mould at the rear side of the machine or entering the mould area from the operator's side		
<p>Question:</p> <p>A machine manufacturer constructs, or retrofits, an injection moulding machine having a tie bar distance $H > 1200\text{mm}$ with a robot on the machine's rear side. In compliance with the standard's specifications, the machine is equipped with an additional safeguarding system in the mould area (e.g. mats). Due to the large dimensions of the enclosed area or the tools installed on site, a person entering the fenced area of the robot from the operator's side or being in the area between the mould and the mobile guard might not be sufficiently visible from the operator's side.</p> <p>What are the measures the machine manufacturer or retrofitter has to take if a situation as the one described above is possible on a machine with $H > 1200\text{mm}$?</p> <p>Background:</p> <p>This matter was raised by a machine manufacturer as manufacturers often have to issue the final conformity assessment after having retrofitted a machine at the customer's plant.</p> <p>There is already a data sheet existing which deals with this subject: CNB/M/04.014; however, this data sheet refers exclusively to machines with $H < 1200\text{mm}$. Thus, this sheet fails to apply to a dimension of $H > 1200\text{mm}$</p> <p>Note: EN ISO 10218-2 (current state is ISO/FDIS 10218-2:2010(E)) describes principals of safety requirement of industrial robot systems and their integration in industrial lines with machines and robot-cells. For alternatives for the safeguarding of the described situation this standard might be considered (e.g.: chapter 5.6.3.4: describes measures for manual reset, start/restart and unexpected start-up).</p> <p>Solution: (see page 2)</p>		

(1) Essential safety requirement

Note: According to point 6.6 of the Guide of the implementation of directives based on the New Approach and the Global Approach, the notified bodies apply as general guidance this recommendation for use.

Solution:

1. A person entering the enclosed area of the robot from the operator's side of the injection moulding machine (IMM) needs to pass an ESPE (mono-beam or multi-beam). Following actuation of this ESPE, an acknowledgment action is necessary at this place before it is possible to start the next machine cycle on the operator's side. An additional pressure-sensitive mat shall be provided on the place where the operator might stay behind the mould between the mould and the rear guard of the machine; this mat shall ensure that although the ESPE has not yet been interrupted the person is detected, and thus prevent initiation of the next machine cycle.

or

2. A double acknowledgment system as described in EN 201, Annex J.2 with the first push located at a position from which a good view of the area hidden by the mould and / or the area of the handling device is possible.

The acknowledgment procedure has to be required automatically by the control system of the machine every time the safety device in the mould area has been actuated. For that reason, this solution could only be used for machines that usually work in fully automatic mode.

	CO-ORDINATION OF NOTIFIED BODIES Machinery Directive 2006/42/EC + Amendment		CNB/M/04.086 Rev 04 Language: E
Date of first stage: 04/09/2014	To be approved by:		Approved on:
Origin: VG 4 Rubber and plastics moulding machines	<input checked="" type="checkbox"/> Vertical Group <input checked="" type="checkbox"/> Horizontal Committee To be endorsed by: <input checked="" type="checkbox"/> Machinery Working Group....		19/05/2015 24/06/2015 Endorsed on: 23/09/2016
Question related to: Directive 2006/42/EC Annex: I	Article: ESR (1): 1.2.1	EN: 201:2009 Clause: 5.1.2.3 CEN TC concerned: TC 145 / WG 1 and TC 270 / WG1	Other: Other clause:
Key words: Electrical axis; Guard locking; detection of standstill			
Question: For machine with electrical axis, guard locking can be necessary. Clause 5.1.2.3 specifies that the detection of standstill shall be safe against single fault. <ol style="list-style-type: none"> 1. What is the standstill detection circuit? 2. How can a “permanent automatic monitoring of the change of position of the platen by means of a motor encoder” be safe against single fault? 			

Solution:

Principal remark: the term “safe against single fault” in the sense of EN201:2009; clause 5.1.2.3 describes a dual channel system but does not specify or require a quality of this system.

1. The standstill detection circuit, is the circuit that detects the axis at the rest and gives the signal for the unlocking of the guard. In the example below the standstill detection circuit is composed by: items n.6, n.5, n.4 and signals transmission components.

F.1 Principle of interlocking corresponding to type III, using electromechanical components

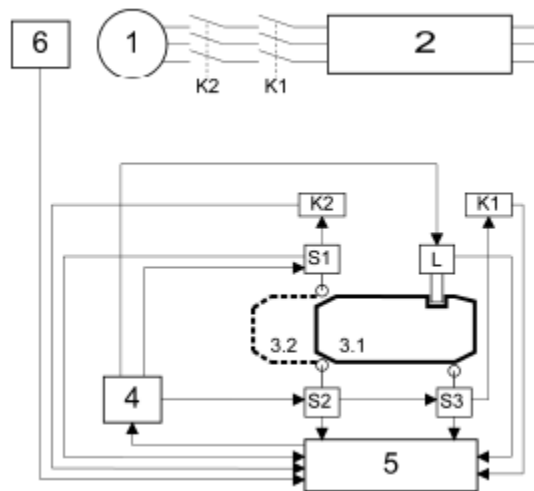

2. Safe against single fault means, that if the fault of the detection control circuit can unlock the guard when the axis is still moving, the locking device shall be monitored and a stop signal shall be immediately generated for the electrical axes every time the locking device is unlocked.

(1) Essential safety requirement

Note: According to point 6.6 of the Guide of the implementation of directives based on the New Approach and the Global Approach, the notified bodies apply as general guidance this recommendation for use.

	CO-ORDINATION OF NOTIFIED BODIES Machinery-Directive 2006/42/EC + Amendment RECOMMENDATION FOR USE		CNB/M/05.002 Revision 05 Language: E
Date of first stage: 19/01/2001	To be approved by :		Approved on :
Origin: VG5 Machines for underground work	<input checked="" type="checkbox"/> Vertical Group <input checked="" type="checkbox"/> Horizontal Committee.....		03/11/2009 07/12/2000
		To be endorsed by:	Endorsed on :
		<input checked="" type="checkbox"/> Machinery Working Group....	04/01/2005
Question related to: Directive 2006/42/EC Annex: I	Article: ESR (1): 1.5.13	EN/prEN: EN 1889-2:2003 Clause: 5.6.3 CEN TC concerned:	Other: Other clause:
Key words: internal combustion engine, emission of dust, gas, exhaust, methane in intake air			
Question:			
What details shall a manufacturer give about the hazardous substances that are contained in the exhaust fume of a diesel engine for use in underground working including mines susceptible to firedamp?			
Solution:			
It is well known, that methane in the intake air negatively influences the emission values of diesel engines. Therefore the manufacturer shall arrange additional tests, in which concentrations of methane of 0,5, 1 and 1,5 Vol. % (see also 5.6.3 EN 1889-2:2003) in the intake air are adjusted. Apart from that CNB/M/05.001/R/E including the whole volume of testing applies.			
Adaptation procedure: FORMAL ADAPTATION IN CONFORMITY WITH DIRECTIVE 2006/42/EC			

(1) Essential safety requirement

Note: According to point 6.6 of the Guide of the implementation of directives based on the New Approach and the Global Approach, the notified bodies apply as general guidance this recommendation for use.

	CO-ORDINATION OF NOTIFIED BODIES Machinery-Directive 2006/42/EC + Amendment RECOMMENDATION FOR USE	CNB/M/05.007 Revision 04 Language: E
Date of first stage: 19/01/2001	To be approved by:	Approved on:
Origin: VG5 Machines for underground work	<input checked="" type="checkbox"/> Vertical Group	03/11/2009
	<input checked="" type="checkbox"/> Horizontal Committee.....	07/12/2000
	To be endorsed by:	Endorsed on :
	<input checked="" type="checkbox"/> Machinery Working Group....	04/01/2005
Question related to: Directive 2006/42/EC Article: Annex: I	EN/prEN: EN 1679-1:1998 Clause: 6.19 CEN TC concerned:	Other: Other clause:
Key words: internal combustion engine, emission of dust, gas, exhaust, limits		
Question: Are the limits for emission of toxic substances in the exhaust gas of internal combustion engines given in clause 6.19 of EN 1679-1 : 1998 acceptable?		
Solution: EN 1679-1:1998 is not sufficient for motors for underground mining, because the limits given there for emission of hazardous substances in the exhaust gas are considered for environmental protection and not suitable for protection of human health. It makes no sense that motors with engine power < 37 kW have to keep no limits. In each case it is necessary to determine the real loads of the hazardous substances e.g. according to CNB/M/05.001 and CNB/M/05.002 so that the user is able to realise that the engine can be used in underground with appropriate ventilation rate.		
Adaptation procedure: FORMAL ADAPTATION IN CONFORMITY WITH DIRECTIVE 2006/42/EC		

(1) Essential safety requirement

Note: According to point 6.6 of the Guide of the implementation of directives based on the New Approach and the Global Approach, the notified bodies apply as general guidance this recommendation for use.

	CO-ORDINATION OF NOTIFIED BODIES Machinery-Directive 2006/42/EC + Amendment RECOMMENDATION FOR USE	CNB/M/05.202 Revision 02 Language : E
Date of first stage: 30/05/1995	To be approved by :	Approved on :
Origin: VG5 Machines for underground work	<input checked="" type="checkbox"/> Vertical Group <input checked="" type="checkbox"/> Horizontal Committee.....	03/11/2009 13/12/1995
	To be endorsed by:	Endorsed on :
	<input checked="" type="checkbox"/> Machinery Working Group....	04/06/1996
Question related to: Directive 2006/42/EC	Article:	EN/prEN:
Annex:	ESR (1):	Other:
	Clause:	Other clause:
	CEN TC concerned:	
Key words: Hydraulic powered roof support, components with safety function, safety components		
Question:		
Which are the components with safety function/safety components for hydraulic powered roof support?		
Solution:		
safety components - examples		
support units: canopy, gob shield, base etc.		
hydraulic rams: rams, adjusting cylinders, canopy cylinders		
hydraulic control devices: check valves, pressure limitation valves (yield valves), control valves for setting props, retracting, alignment, advancing		
electro hydraulic control devices: discrete control devices, emergency off devices, sensors which initiate movements, master control devices, software		
Adaptation procedure: FORMAL ADAPTATION IN CONFORMITY WITH DIRECTIVE 2006/42/EC		

(1) Essential safety requirement

Note: According to point 6.6 of the Guide of the implementation of directives based on the New Approach and the Global Approach, the notified bodies apply as general guidance this recommendation for use.

	CO-ORDINATION OF NOTIFIED BODIES Machinery-Directive 2006/42/EC + Amendment RECOMMENDATION FOR USE	CNB/M/05.208 Revision 03 Language: E	
Date of first stage: 23/06/1997	To be approved by :	Approved on :	
Origin: VG5 Machines for underground work	<input checked="" type="checkbox"/> Vertical Group <input checked="" type="checkbox"/> Horizontal Committee..... To be endorsed by: <input checked="" type="checkbox"/> Machinery Working Group....	03/11/2009 12/12/1995 Endorsed on : 04/06/1996	
Question related to: Directive 2006/42/EC	Article:	EN/prEN:	Other:
Annex:	ESR (1):	Clause:	Other clause:
Key words: Hydraulic powered roof support, placing on the market, putting into service Question: What are the most common manufacturing, modification and repair combinations by which new/modified or used hydraulic powered roof supports are placed on the market ? Solution: Placing on the market, putting into service of hydraulic powered roof supports: Cases a) new hydraulic powered roof support one manufacturer b) new hydraulic powered roof support several manufacturers c) used hydraulic powered roof support original manufacturer modifies type d) used hydraulic powered roof support non-original manufacturer modifies type e) unchanged type of hydraulic powered roof support authorized before 01-01-95 is placed on the market anew. Adaptation procedure: FORMAL ADAPTATION IN CONFORMITY WITH DIRECTIVE 2006/42/EC			

(1) Essential safety requirement

Note: According to point 6.6 of the Guide of the implementation of directives based on the New Approach and the Global Approach, the notified bodies apply as general guidance this recommendation for use.

	CO-ORDINATION OF NOTIFIED BODIES Machinery-Directive 2006/42/EC + Amendment RECOMMENDATION FOR USE	CNB/M/05.220 Revision 05 Language: E
Date of first stage: 19/01/2001	To be approved by:	Approved on:
Origin: VG5 Machines for underground work	<input checked="" type="checkbox"/> Vertical Group <input checked="" type="checkbox"/> Horizontal Committee..... To be endorsed by: <input checked="" type="checkbox"/> Machinery Working Group....	03/11/2009 07/12/2000 Endorsed on : 04/01/2005
Question related to: Directive 2006/42/EC Article: Annexes: IV, 12.2, IX ESR (1):	EN/prEN: Clause: CEN TC concerned:	Other: Other clause:
Key words: Hydraulic powered roof support, support unit, technical file, EC-type examination		
Question: What is a representative model for the EC-type examination procedure of different types of hydraulic powered roof support machinery?		
Solution: 1) New hydraulic powered roof support as a whole or parts of it have to comply in any case with all applicable requirements of the directive before being placed on the market (e.g. EC-type examination if harmonised standards are not used). 2) In the case of replacement of components with safety function of hydraulic powered roof supports like legs, hydraulic control system or structural steel elements, which do not change the function, the person who replaces the components of the machine shall ensure the compatibility of these components. The replaced component shall be type tested and a certificate shall be issued by a notified body. A new EC-type examination certificate for the entire machine is not necessary. 3) In the case of replacement of components which change the function of the machine (e.g. changing of the media bearing force, automation of motions, change of dimensions) a new EC-type examination certificate is required. The tests required shall be specified in each case. Generally the tests cover the components themselves, the respective interfaces and the changes of function caused thereby. 4) New hydraulic powered roof support machines require EC-type examination certificates before they may be placed on the market regardless of whether identical machines placed on the market before January 1, 1995 had been homologated by a national authority. Existing test reports shall be recognised. The extend of additional tests and the documentation required shall be specified in each case. 5) The application for an EC-type examination shall include the following documentation: - for support units according to recommendation for use CNB/M/05.204/R/E, rev. 02, 19.11.1996 - for hydraulic control systems and valves according to recommendation for use CNB/M/05.205/R/E, rev. 02, 19.11.96 - for electro hydraulic control systems and components according to recommendation for use CNB/M/05.206/R/E, rev 02, 19.11.1996 - for legs and rams within the flow of the media bearing force according to recommendation for use CNB/M/05.207, rev. 02, 19.11.1996 Adaptation procedure: FORMAL ADAPTATION IN CONFORMITY WITH DIRECTIVE 2006/42/EC		

(1) Essential safety requirement

Note: According to point 6.6 of the Guide of the implementation of directives based on the New Approach and the Global Approach, the notified bodies apply as general guidance this recommendation for use.

	<p>CO-ORDINATION OF NOTIFIED BODIES Machinery-Directive 2006/42/EC + Amendment</p> <p>RECOMMENDATION FOR USE</p>		<p>CNB/M/05.601 Revision 05 Language: E</p>
<p>Date of first stage: 19/01/2001</p>	<p>To be approved by:</p>		<p>Approved on:</p>
<p>Origin: VG5 Machines for underground work</p>	<p><input checked="" type="checkbox"/> Vertical Group</p> <p><input checked="" type="checkbox"/> Horizontal Committee.....</p> <p style="text-align: center;">To be endorsed by:</p> <p><input checked="" type="checkbox"/> Machinery Working Group....</p>		<p>03/11/2009 07/12/2000</p> <p style="text-align: center;">Endorsed on :</p> <p>04/01/2005</p>
<p>Question related to: Directive 2006/42/EC Annexes: IV, 12.1</p>	<p>Article: ESR (1):</p>	<p>EN/prEN: EN 1889-2:2003/A1:2009 Clause: CEN TC concerned:</p>	<p>Other: Other clause:</p>
<p>Key words : locomotive, EC-type examination, running test</p>			
<p>Question :</p> <p>In EN 1889-2:2003/A1:2009, running tests for locomotives have been provided. However there is no suitable test course available on the surface. How, when and where can these tests be realized?</p>			
<p>Solution :</p> <ol style="list-style-type: none"> 1. In the type test, the notified body shall check, if the locomotive fulfils the requirements for safe running in principle. In particular the notified body shall prove the adaptability of the running gear/bogie including the brake system relating to the relevant demands in underground working. 2. As far as running tests can not be realized on the surface completely, the missing tests have to be carried out at the beginning of putting the locomotive in operation underground. All these relevant checks, the duty for careful realization of these checks and their documentation have to be specified in the operators manual. The notified body has to be involved with, at least he must get the required documentation for proving. <p>Adaptation procedure: FORMAL ADAPTATION IN CONFORMITY WITH DIRECTIVE 2006/42/EC</p>			

(1) Essential safety requirement

Note: According to point 6.6 of the Guide of the implementation of directives based on the New Approach and the Global Approach, the notified bodies apply as general guidance this recommendation for use.

	<p align="center">CO-ORDINATION OF NOTIFIED BODIES Machinery-Directive 2006/42/EC + Amendment</p> <p align="center">RECOMMENDATION FOR USE</p>		<p>CNB/M/05.604 Revision 05 Language: E</p>
Date of first stage: 19/01/2001	To be approved by:		Approved on:
Origin: VG5 Machines for underground work	<input checked="checked" type="checkbox"/> Vertical Group		03/11/2009
	<input checked="checked" type="checkbox"/> Horizontal Committee.....		07/12/2000
	To be endorsed by:		Endorsed on :
	<input checked="checked" type="checkbox"/> Machinery Working Group....		04/01/2005
Question related to: Directive 2006/42/EC Annex: IV 12.1	Article: ESR (1):	EN/prEN: Clause: CEN TC concerned:	Other: Other clause:
Key words: locomotive, definition			
<p>Question: What is a locomotive for underground working?</p>			
<p>Solution: A locomotive is a self-powered uncaptivated vehicle running on a track of one or two rails underground in mines or other underground workings, designed for hauling or transporting persons, materials or mineral. Usually the rails are situated above or under the vehicle.</p> <p align="center">Adaptation procedure: FORMAL ADAPTATION IN CONFORMITY WITH DIRECTIVE 2006/42/EC</p>			

(1) Essential safety requirement

Note: According to point 6.6 of the Guide of the implementation of directives based on the New Approach and the Global Approach, the notified bodies apply as general guidance this recommendation for use.

	CO-ORDINATION OF NOTIFIED BODIES Machinery Directive 2006/42/EC + Amendment RECOMMENDATION FOR USE	CNB/M/06.005 Revision 05 Language: E
Date of first stage:	To be approved by:	Approved on:
Origin: VG6 Refuse collection vehicles	<input checked="" type="checkbox"/> Vertical Group <input checked="" type="checkbox"/> Horizontal Committee To be endorsed by: <input checked="" type="checkbox"/> Machinery Working Group....	15/04/2010 11/03/1997 Endorsed on: 08/06/1998
Question related to: Directive 2006/42/EC Article: Annex: I ESR (1): 1.3.1 and 1.3.2	EN/prEN: EN 1501-1:1998 + A2:2009 Clause: 6.11 CEN TC concerned: TC 183	Other: Other clause:
Key words: Refuse collection vehicle (RCV) - calculations		
Question: Which calculation shall be required from the manufacturer for an EC-type examination and which safety factors should be considered?		
Solution: The participants unanimously agreed on requiring following calculation from the manufacturer: <u>Stress calculation:</u> a) hinges, locks and cylinders at the tailgate b) safety props for the opened tailgate c) safety props for suspending the vehicle at rear, if fitted, including relevant parts e.g. hinges d) fitting points and lifting arms of the lifting device, if required by the testing engineer. <u>Stability calculation:</u> The stability calculation shall be done according to 6.11 of EN1501-1:2009 The safety factor shall be 1,25. Adaptation procedure: FORMAL ADAPTATION IN CONFORMITY WITH DIRECTIVE 2006/42/EC		

(1) Essential safety requirement

Note: According to point 6.6 of the Guide of the implementation of directives based on the New Approach and the Global Approach, the notified bodies apply as general guidance this recommendation for use.

	<p align="center">CO-ORDINATION OF NOTIFIED BODIES Machinery Directive 2006/42/EC + Amendment</p> <p align="center">RECOMMENDATION FOR USE</p>		<p>CNB/M/06.012 Revision 06</p> <p>Language: E</p>
	<p>Date of first stage: 25/07/1997</p>	<p>To be approved by:</p> <p><input checked="" type="checkbox"/> Vertical Group</p> <p><input checked="" type="checkbox"/> Horizontal Committee</p>	<p>Approved on:</p> <p>15/04/2010</p> <p>10/06/2008</p>
<p>Origin: VG6 Refuse collection vehicles</p>	<p>To be endorsed by:</p> <p><input checked="" type="checkbox"/> Machinery Working Group....</p>	<p>Endorsed on:</p> <p>08/01/2009</p>	
<p>Question related to: Directive 2006/42/EC Article:</p> <p>Annex: I ESR (1): 1.2.5</p>	<p>EN/prEN: EN 1501-1:1998 + A2:2009</p> <p>Clause: 6.3.12 and 6.3.13</p> <p>CEN TC concerned: TC 183</p>	<p>Other:</p> <p>Other clause:</p>	
<p>Key words: Refuse collection vehicle (RCV)-automatic lifting device-operation mode</p>			
<p>Question:</p> <p>Is it allowed to repeat the discharging movement of a waste container by pushing the button for manually controlled lifting, before the entire automatic emptying cycle has been finished?</p> <p>For explanation: If waste doesn't slide out of the waste container, the discharging can be supported by shaking the waste container in its tilted position.</p>			
<p>Solution:</p> <p>No, the requirements for changing over the operation mode are given in EN 1501-1:1998 + A2:2009 and pr EN 1501-1:2009 clauses 6.3.12, 6.3.13 and 6.3.14.</p> <p>Manually initiated shaking of the waste container in the fully tilted position is to be deemed as an interruption of the automatic cycle.</p> <p>Continuing the automatic cycle requires a deliberate action of the operative.</p>			
<p>Adaptation procedure: FORMAL ADAPTATION IN CONFORMITY WITH DIRECTIVE 2006/42/EC</p>			

(1) Essential safety requirement

Note: According to point 6.6 of the Guide of the implementation of directives based on the New Approach and the Global Approach, the notified bodies apply as general guidance this recommendation for use.

	<p>CO-ORDINATION OF NOTIFIED BODIES Machinery Directive 2006/42/EC + Amendment</p> <p>RECOMMENDATION FOR USE</p>	<p>CNB/M/06.016 Revision 05</p> <p>Language: E</p>
<p>Date of first stage: 25/07/1997</p> <p>Origin: VG6 Refuse collection vehicles</p>	<p>To be approved by:</p> <p><input checked="" type="checkbox"/> Vertical Group</p> <p><input checked="" type="checkbox"/> Horizontal Committee</p> <p>To be endorsed by:</p> <p><input checked="" type="checkbox"/> Machinery Working Group....</p>	<p>Approved on:</p> <p>15/04/2010</p> <p>11/03/1997</p> <p>Endorsed on:</p> <p>08/06/1998</p>
<p>Question related to: Directive 2006/42/EC Article:</p> <p>Annex: I ESR (1): 1.6.3 and 3.5.1</p>	<p>EN/prEN: EN 1501-1:1998 + A2:2009</p> <p>Clause: 6.7.5</p> <p>CEN TC concerned: TC 183</p>	<p>Other: EN 60204-1:2006 + A1: 2009</p> <p>Other clause:</p>
<p>Key words: Refuse collection vehicle (RCV) - energy separation main switch</p>		
<p>Question:</p> <p>What are the conditions for the statutory objective as defined in EHSR 1.6.3 (Isolation of energy sources) to be considered as having been fulfilled?</p>		
<p>Solution:</p> <p>Due to EN 1501-1:1998 + A2:2009 clause 6.7.5 a separate main switch for the body work conform to EN 60204-1:2006 + A1:2009 shall be fitted. Additionally the hydraulic pump shall be switched ineffective either by switching off (e.g. electromagnetic clutch) or electro-hydraulic by passing. The main switch for the body work must be lockable in the off-position.</p> <p>Note: For the colour of the main switch, see 5.3.3 of EN 60204-1:2006+A1:2009.</p> <p>Adaptation procedure: FORMAL ADAPTATION IN CONFORMITY WITH DIRECTIVE 2006/42/EC</p>		

(1) Essential safety requirement

Note: According to point 6.6 of the Guide of the implementation of directives based on the New Approach and the Global Approach, the notified bodies apply as general guidance this recommendation for use.

	<p align="center">CO-ORDINATION OF NOTIFIED BODIES Machinery Directive 2006/42/EC + Amendment</p> <p align="center">RECOMMENDATION FOR USE</p>		<p>CNB/M/06.023 Revision 08</p> <p>Language: E</p>
Date of first stage: 25/07/1997	To be approved by:		Approved on:
Origin: VG6 Refuse collection vehicles	<input checked="" type="checkbox"/> Vertical Group <input checked="" type="checkbox"/> Horizontal Committee	15/04/2015 24/06/2015	
Question related to: Directive 2006/42/EC Article: Annex: I ESR (1): 1.5.3 and 1.5.5	EN 1501-1:2011 Clause: 5.3.2 CEN TC concerned: TC 183	Other: Other clause:	
Key words: Refuse collection vehicle (RCV) - Hose burst protection valves			
<p>Question: What kind of hose burst protection valves can be approved regarding the writing in EN 1501-1: 2011 Are simple lock valves (spring loaded) acceptable? Or is a more sophisticated lowering device required?</p>			
<p>Solution: To prevent raised tailgates from falling caused by hose bursts, any type of safety valve (e.g. like flow sensitive check valves) fulfilling the test requirements is acceptable, if they are fitted directly to the lifting rams of tailgates. The valves are to be thoroughly tested during the EC type examination, ensuring that in the event of a hose burst on one side only, both valves have to operate in sufficient time to minimise any distortion on the tailgate hinges. It is strongly recommended that manufacturers conduct the same tests on each RCV produced.</p> <p>Adaptation procedure: FORMAL ADAPTATION IN CONFORMITY WITH DIRECTIVE 2006/42/EC</p>			

	CO-ORDINATION OF NOTIFIED BODIES Machinery Directive 2006/42/EC + Amendment RECOMMENDATION FOR USE	CNB/M/06.025 Revision 03 Language: E
Date of first stage: 22/04/1997	To be approved by:	
Origin: VG6 Refuse collection vehicles	<input checked="" type="checkbox"/> Vertical Group <input checked="" type="checkbox"/> Horizontal Committee	Approved on: 15/04/2010 10/06/2008
To be endorsed by:		
<input checked="" type="checkbox"/> Machinery Working Group....		
Question related to: Directive 2006/42/EC Article:	EN/prEN: EN 1501-1:1998 + A2:2009	Other: EN 60204-1:2006 + A1:2009; pr EN 1501-1:2009
Annex: I	ESR (1): 1.5.1	Other clause:
Clauses: 2 and 6.8.1.1		
CEN TC concerned:		
Key words: Refuse collection vehicle (RCV) - electrical equipment		
Question:		
What kind of electrical tests shall be required?		
Solution:		
The isolation resistance test and the functional test shall be carried out in any case according to EN 60204-1:2006 + A1:2009. Measuring of residual voltage after switching off operation depends on the residual risks.		

Adaptation procedure: FORMAL ADAPTATION IN CONFORMITY WITH DIRECTIVE 2006/42/EC

(1) Essential safety requirement

Note: According to point 6.6 of the Guide of the implementation of directives based on the New Approach and the Global Approach, the notified bodies apply as general guidance this recommendation for use.

	<p style="text-align: center;">CO-ORDINATION OF NOTIFIED BODIES Machinery Directive 2006/42/EC + Amendment</p> <p style="text-align: center;">RECOMMENDATION FOR USE</p>	<p>CNB/M/06.027 Revision 07</p> <p>Language: E</p>
<p>Date of first stage: 29/09/1998</p>	<p style="text-align: center;">To be approved by:</p> <p><input checked="" type="checkbox"/> Vertical Group</p> <p><input checked="" type="checkbox"/> Horizontal Committee</p> <p style="text-align: center;">To be endorsed by:</p> <p><input checked="" type="checkbox"/> Machinery Working Group....</p>	<p style="text-align: center;">Approved on:</p> <p style="text-align: right;">15/04/2010</p> <p style="text-align: right;">15/06/2010</p> <p style="text-align: center;">Endorsed on:</p> <p style="text-align: right;">30/12/2010</p>
<p>Origin: VG6 Refuse collection vehicles</p>		<p>Question related to: Directive 2006/42/EC Article:</p> <p>Annex: I ESR (1): 1.3.1 and 1.3.2</p>
<p>Key words: Refuse collection vehicle (RCV) - fixing points of the bodywork on the chassis</p>		
<p>Question:</p> <p>A) Is a strength calculation required for the fixing points of the bodywork on the chassis from the bodywork manufacturer?</p> <p>B) Is a stress calculation required for the fitting elements of the bodywork on the chassis (e.g. screws, bolts) from the bodywork manufacturer?</p>		
<p>Solution:</p> <p>A) No, the bodywork manufacturer shall state in the assembling manual or the user's manual:</p> <ul style="list-style-type: none"> - the dead weight of the bodywork, - the expected total weight (mass) of the bodywork; - the maximum permitted acceleration/ deceleration of the RCV (normally calculated by $8m/sec^2$) <p>That information, the assembler shall consider following the conditions for assembling given by the chassis manufacturer.</p> <p>B) Yes, stress calculation shall be part of the technical construction file of the bodywork manufacturer. The bodywork manufacturer has to define the fitting elements, which the assembler has to respect in conjunction with the chassis manufacturer requirements.</p>		

(1) Essential safety requirement

Note: According to point 6.6 of the Guide of the implementation of directives based on the New Approach and the Global Approach, the notified bodies apply as general guidance this recommendation for use.

 <p>EUROPEAN CO-ORDINATION OF NOTIFIED BODIES MACHINERY</p>	<p>CO-ORDINATION OF NOTIFIED BODIES Machinery Directive 2006/42/EC + Amendment</p> <p>RECOMMENDATION FOR USE</p>	<p>CNB/M/06.029 Revision 04</p> <p>Language: E</p>
<p>Date of first stage: 05/02/1999</p>	<p>To be approved by:</p>	
<p>Origin: VG6 Refuse collection vehicles</p>	<p><input checked="" type="checkbox"/> Vertical Group</p> <p><input checked="" type="checkbox"/> Horizontal Committee</p>	<p>Approved on:</p> <p>15/04/2010 09/12/1998</p>
<p>Question related to: Directive 2006/42/EC Article:</p> <p>Annex: I ESR (1): 1.4 and 3.2.3</p>	<p>EN/prEN: EN 1501-1:1998 + A2:2009</p> <p>Clause: 6.6.4.3</p> <p>CEN TC concerned: TC 183</p>	<p>Other: pr EN 1501-1:2009</p> <p>Other clause:</p>
<p>Key words: Refuse collection vehicle (RCV) - footboards</p>		
<p>Question:</p> <p>Is a monitoring device according to EN 1501-1:1998 + A2:2009 clause 6.6.4.3 when fitted, defined as a protection device in the sense of Machinery Directive Annex I, clause 1.4.1, which requires that easy by-passing of the footboard control (standing on a structure part of the body or the lifting device with at least one foot) by the operator shall be prevented?</p>		
<p>Solution:</p> <p>It is comparable with a protection device, because the footboard monitoring system is integrated into the control system of the RCV and it contains safety functions.</p> <p>The system itself cannot prevent intentional misuse, e.g. by-passing by travelling on the lifting device or on other structural components.</p> <p>The use of the monitoring device together with labelling and camera system shall be accepted.</p> <p>Adaptation procedure: FORMAL ADAPTATION IN CONFORMITY WITH DIRECTIVE 2006/42/EC</p>		

(1) Essential safety requirement
 Note: According to point 6.6 of the Guide of the implementation of directives based on the New Approach and the Global Approach, the notified bodies apply as general guidance this recommendation for use.

	CO-ORDINATION OF NOTIFIED BODIES Machinery Directive 2006/42/EC + Amendment RECOMMENDATION FOR USE	CNB/M/06.034 Revision 10 Language: E
Date of first stage: 23/11/2001	To be approved by:	
Origin: VG6 Refuse collection vehicles	<input checked="" type="checkbox"/> Vertical Group <input checked="" type="checkbox"/> Horizontal Committee.....	Approved on: 15/04/2015 24/06/2015
To be endorsed by:		
<input type="checkbox"/> Machinery Working Group....		
Question related to: Directive 2006/42/EC Article: Annex: I ESR (1): 3.2.3		EN/prEN: EN 1501-1: 2011 Other: Clause: 5.10. Other clause: CEN TC concerned: TC 183
Key words: Refuse collection vehicle (RCV) - rear footboard		
<p>Question:</p> <p>What are the minimum criteria of a RCV's rear footboard and its monitoring device of forward speed limitation and reverse prevention to be accepted carrying out a type examination on the RCV?</p>		
<p>Solution:</p> <p>Particularly following requirements shall be fulfilled to accept rear footboards at a RCV performing an EC-type examination certificate:</p> <p>1. Footboard and handles:</p> <p>The mechanical design of the footboard and the handles compulsory provided shall comply with EN 1501-1: 2011, clause 5.10.3.1 and 5.10.3.2 and Fig. B.4.1 and B.4.2. There shall no shear trap be created between lifting device and footboard. For safety distances see EN 349. In the reach of the footboard there shall be no other facility to ride on except on the lifting device itself which can not be avoided. The footboard folded down, its carrying structure and weight indication device when fitted shall withstand a vertical static test load of 250 kg located in the centre of the footboard. After the test there shall be no permanent deflection or crack.</p> <p>2. Monitoring device:</p> <p>2.1 Detecting device</p> <p>The detection of a person riding on the footboard is possible by:</p> <p>2.1.1 Position indication:</p> <p>In case of position monitoring restrictions shall be effective when the footboard is folded down of more than 10° from the totally folded up position. If there is a capability to stand on the footboard or its carrying structure when folded up, a vertical force of more than 400 N at any point of the footboard or its carrying structure shall fold totally down the footboard automatically. This requirement does not occur, when in the totally folded up position of the footboard its outer edge is more than 800 mm above the ground and any other surface of its carrying structure has an angle of more than 45° to the horizontal. The dimensions are measured when the RCV standing on an even horizontal ground is empty.</p> <p>Adaptation procedure: FORMAL ADAPTATION IN CONFORMITY WITH DIRECTIVE 2006/42/EC</p>		

(1) Essential safety requirement

Note: According to point 6.6 of the Guide of the implementation of directives based on the New Approach and the Global Approach, the notified bodies apply as general guidance this recommendation for use.

The footboard shall be secure against unintended folding down which can cause an unintended braking down. When folding is powered the powering force shall be limited to 75 N measured at any point where a person can stand on. The folding speed measured at the rear of the footboard shall not exceed 0,6 m/sec. Thus to avoid injuries to the operative's leg when getting off the footboard and the relevant control is activated. The operation control shall be of hold-to-run-type and shall be located at the rear wall of the tailgate and in the cab.

2.1.2 weight indication:

In case of weight indication the restrictions shall be effective when a vertical force of at least 300 N acts onto the footboard totally folded down or its carrying structure in a minimum distance away from the pivoting hinge as a foot can stand on. Riding on the moveable footboard carrying structure when the footboard is folded down as well as on the fix carrying structure in any case shall be prevented by design. Easy bypassing the weight indication by supporting the footboard by means of a rope, chain, etc. or blocking it in a position not folded out totally shall be prevented by the design. The weight indication will only be accepted when the capability of easy bypassing, e. g. as mentioned above is permanently prevented.

The weight detection shall be effective at any temperature the RCV is designed for as stated in the "information for use" (operator's manual) with no drift of the forces. The period of necessary readjustment shall be stated in the "information for use" (operator's manual) and should not be less than the normal inspection period given in the user's manual.

Further more there shall no facility in easy reach of the footboard where on the operative can support himself to reduce his weight force acting on the footboard.

2.1.3 space indication

In case of space indication the operative shall be detected at any position on the footboard or its carrying structure independent from his cloth's colour and performance. Nothing else than a person positioned on the footboard shall be detected particularly other traffic participants (vehicles or pedestrians) or the road itself, when the footboard is folded down.

The space indication shall be effective at any temperature the RCV is designed for as stated in the "information for use" (operator's manual) with no drift of the detected area and no reduce of the detecting sensitivity.

2.1.4 Braking requirements for systems as described under 2.1.1 to 2.1.3:

Jumping onto the footboard during reversing up to 6 km/h shall stop the RCV within the distance between the rear edge of the footboard and the rear point of the rear wheel (see figure below).

At higher speeds the braking shall also be activated and the stopping distance may become longer but as short as possible.

This shall be measured on a dry horizontal even ground.

2.2 Restrictions

When one or both footboards are detected as occupied following restrictions shall apply:

- speed limitation on forward motion of the RCV up to 30 km/h, tested by means of the chassis own tachograph.
- prevention of reverse of the RCV in any case (see RFU 06.031).
- prevention of operating the lifting device when provided. This does not apply when the risk of unintentionally being crushed or sheared is prevented by a sufficient safeguard.
- prevention of operating the compaction mechanism in the automatic mode on an open system according to EN 1501-1.
- after use of the footboard automatic restart of bodywork or chassis functions shall be prevented.

(See also EN 1501-1)

2.3 Monitoring control:

2.3.1 Examining that part of the monitoring control which is origin part of the chassis is not task of the notified body performing an EC-type-examination. It shall only be tested according to its function.

2.3.2 The entire control including the detectors shall be designed not to be rendered ineffectively or to set out of operation by simple tools according to EN 1088. Particularly cutting a wire, disconnecting a plug connection out of a screwed box, removal of a detector, shadow respective making blind a sensor for space indication, and a failure of one component of the footboard monitoring control shall lead to the restrictions be effective (One failure safe). This shall be in accordance with the category 3 of the standard EN ISO 13849-1:2008.

To avoid manipulation, the check of the footboard control shall be made after each engine stop, at least before the compaction mechanism or /and the lifting device can be started. This check may not be the precondition for the chassis to drive faster than 30 km/h.

2.3.3 Environmental influences e.g. spot lights, part of trees approach of other vehicles, shall not lead to the restrictions be effective.

2.3.4 Cables and wires out of boxes shall withstand the environmental influences and shall be protected against mechanical damages. Components located on the outer surface of the RCV shall comply with IP 65 according to EN 60529+A1:2002.

2.3.5 To enable reverse in case of the monitoring system is destroyed e.g. by a traffic accident a push button shall be provided in the cab which bypasses the reverse restriction and prevents the operation of the bodywork including lifting device. Resetting shall only be possible by a key which shall not be identically with the ignition key or the cab door key. The push button shall be sealed. The "information for Use"

(operator's manual) shall state that the key shall be separated from the RCV. Resetting the push button it shall take at least 5 minutes before the RCV is ready for use again.

2.4 Communications

The working area needed to be observed including the footboards. Therefore the Closed Circuit Television System (CCTV) mentioned in 5.12.1. of EN 1501-1 shall not be capable of switching off during work and transport at any time when the ignition key is switched on.

2.5 Warning

To avoid traffic accidents by the slow going vehicle the flashing beacon according to 7.1.2.2 of prEN 1501-1: 2011 shall be engaged automatically when the footboards are occupied or the bodywork is switched on.

(National traffic rules shall be considered)

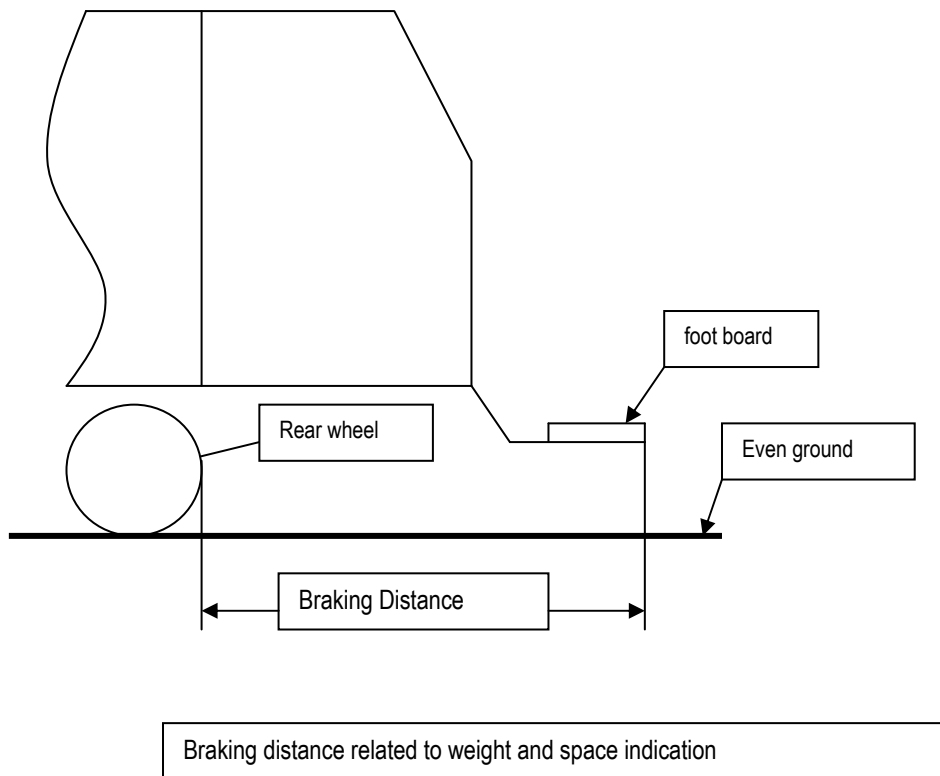

	<p>CO-ORDINATION OF NOTIFIED BODIES Machinery Directive 2006/42/EC + Amendment</p> <p>RECOMMENDATION FOR USE</p>	<p>CNB/M/06.035 Revision 05</p> <p>Language: E</p>
<p>Date of first stage: 23/11/2001</p> <p>Origin: VG6 Refuse collection vehicles</p>	<p>To be approved by:</p> <p><input checked="" type="checkbox"/> Vertical Group</p> <p><input checked="" type="checkbox"/> Horizontal Committee</p> <p>To be endorsed by:</p> <p><input checked="" type="checkbox"/> Machinery Working Group....</p>	<p>Approved on:</p> <p>16/04/2010</p> <p>04/12/2001</p> <p>Endorsed on:</p> <p>04/01/2005</p>
<p>Question related to: Directive 2006/42/EC Article:</p> <p>Annex: I ESR (1): 4.2.2</p>	<p>EN/prEN: EN 1501-1:1998 + A2:2009</p> <p>Clause:</p> <p>CEN TC concerned: TC 183</p>	<p>Other:</p> <p>Other clause:</p>
<p>Key words: Refuse collection vehicle (RCV) - lifting device</p>		
<p>Question:</p> <p>How overloading of a lifting device shall be avoided?</p>		
<p>Solution:</p> <p>Because lifting devices are designed for emptying waste containers of different sizes within the same type which have an identical picking up system any lifting device shall be marked or labelled with the max. permissible lifting mass in kg taking into account the biggest waste container to be emptied according to the relevant standard e.g. EN 840. The mark/label shall be located in the clear view of the pressure relief valve adjusted for prevention of lifting loads in excess of the permissible lifting mass shall be provided. This also occurs for each part of a split lifting device.</p> <p><u>Caution:</u> An overload protection of the waste container as standardised by the lifting device is not practical!</p> <p><u>Attention:</u> For labelling/markings see also CNB/M/06.038.</p> <p>Adaptation procedure: FORMAL ADAPTATION IN CONFORMITY WITH DIRECTIVE 2006/42/EC</p>		

(1) Essential safety requirement

Note: According to point 6.6 of the Guide of the implementation of directives based on the New Approach and the Global Approach, the notified bodies apply as general guidance this recommendation for use.

	<p>CO-ORDINATION OF NOTIFIED BODIES Machinery Directive 2006/42/EC + Amendment</p> <p>RECOMMENDATION FOR USE</p>	<p>CNB/M/06.036 Revision 07</p> <p>Language: E</p>
<p>Date of first stage: 22/11/2001</p>	<p>To be approved by:</p>	
<p>Origin: VG6 Refuse collection vehicles</p>	<p><input checked="" type="checkbox"/> Vertical Group</p> <p><input checked="" type="checkbox"/> Horizontal Committee</p> <p>To be endorsed by:</p> <p><input checked="" type="checkbox"/> Machinery Working Group....</p>	<p>Approved on:</p> <p>24/04/2013 26/06/2013</p> <p>Endorsed on:</p> <p>22/11/2013</p>
<p>Question related to: Directive 2006/42/EC Article:</p> <p>Annex: I ESR (1): 1.2.2</p>	<p>EN/prEN: EN 1501-5:2011 Other:</p> <p>Clause: 5.1.1.2 Other clause:</p> <p>CEN TC concerned: TC 183</p>	
<p>Key words: Refuse collection vehicle (RCV) - remote control in the cab</p>		
<p>Question:</p> <p>Is a remote control for the lifting device in the cab acceptable?</p>		
<p>Solution:</p> <p>No, a remote control for operating the complete lifting cycle from the cab is not acceptable because there is no clear view of the lifting device in the cab. Even when a CCTV is provided at the rear persons particularly children approaching the lifting device in motion cannot be identified clearly and early enough.</p> <p>To avoid collisions between the road and the lifting device when lowered during transport only one exception of lifting operations from the cab is acceptable under following conditions:</p> <ul style="list-style-type: none"> - max. lifting height of 400 mm from the lowest possible position of the waste container carriage - any crushing and shearing risk is prevented - safe limitation of the lifting height - lowering from the cab is prevented - automatic lifting to a maximum height of 400 mm may be acceptable only after the RCV has started rolling. 		

(1) Essential safety requirement

Note: According to point 6.6 of the Guide of the implementation of directives based on the New Approach and the Global Approach, the notified bodies apply as general guidance this recommendation for use.

	CO-ORDINATION OF NOTIFIED BODIES Machinery Directive 2006/42/EC + Amendment RECOMMENDATION FOR USE		CNB/M/06.039 Revision 03 Language: E
Date of first stage: 23/11/2001	To be approved by:		Approved on:
Origin: VG6 Refuse collection vehicles	<input checked="" type="checkbox"/> Vertical Group <input checked="" type="checkbox"/> Horizontal Committee		16/04/2010 24/10/2002
	To be endorsed by:		Endorsed on:
Question related to: Directive 2006/42/EC Article: Annex: I ESR (1): 1.4.3	EN/prEN: EN 1501-1:1998 + A2:2009 Clause: 6.1.2.3 CEN TC concerned: TC 183	Other: EN 954-1:1996, EN 999:2008, EN 61496-1:2009; Other clause:	
Key words: Refuse collection vehicle (RCV) - rave rail / open operation system			
Question: Is a continuous operating compaction mechanism in an open operation modus according to EN 1501-1:1998 + A2:2009, clause 6.1.2.3 acceptable when the aperture to the hopper is safeguarded by an electro sensitive protective device?			
Solution: Yes, under following conditions: <ul style="list-style-type: none"> • The electro sensor protective system shall be conform with EN 61496-1:2009 and fulfil the requirements of a type 4. • The control of that system shall be conform with Category 3 of EN 954-1:1996 at the minimum. • The protection device shall be effective at any time the compaction mechanism is in operation. • Restart of the compaction system shall not be possible without manual reset. This shall only be capable with direct clear view of the rave rail. The only exception allowing automatic restart is by a signal from the lifting device leaving the guarded area. • The system shall not be capable to be by-passed. When light barriers or similar devices are used, lateral access from the footboard, when provided, as well as gripping through of children's arm shall be considered. • The maximum velocity of approach of a children's arm/hand shall be considered, which is assumed to be approximately 2,7 m/s. • When a light curtain or similar device is used, the distance between the inside of the rave rail and the curtain shall be such that under consideration of the above mentioned velocity the compaction mechanism has already stopped when the hand has reached the dangerous zone. The minimum distance shall be 175 mm and has to be calculated according page 2, Annex 1 (see also EN 999:1998). • The designed temperature range for operation shall be according to the area of the RCV's intended use (North of the Alps in general - 20°C to + 40°C). • Light barriers or similar devices shall not be used when split lifting devices are provided, except they create a close system mechanically according to EN 1501-1:1998 + A2:2009 clause 6.1.2.2. • Environmental influences e.g. snow, rain, hair frost shall not impede the safe function. • Inside detection of the hopper only does not fulfil the requirement of safe approach. The device and its components shall be sufficiently shock and vibration resistant (see EN 61496-1). Adaptation procedure: FORMAL ADAPTATION IN CONFORMITY WITH DIRECTIVE 2006/42/EC			

(1) Essential safety requirement

Note: According to point 6.6 of the Guide of the implementation of directives based on the New Approach and the Global Approach, the notified bodies apply as general guidance this recommendation for use.

	CO-ORDINATION OF NOTIFIED BODIES Machinery Directive 2006/42/EC + Amendment RECOMMENDATION FOR USE	CNB/M/06.040 Revision 03 Language: E
Date of first stage: 15/01/2003	To be approved by:	Approved on:
Origin: VG6 Refuse collection vehicles	<input checked="" type="checkbox"/> Vertical Group <input checked="" type="checkbox"/> Horizontal Committee To be endorsed by: <input checked="" type="checkbox"/> Machinery Working Group....	16/04/2010 11/12/2003 Endorsed on: 01/07/2004
Question related to: Directive 2006/42/EC Article: Annex: I ESR (1): 3.2.3	EN/prEN: EN 1501-2:2005 + A1:2009 Clause: 6.8 CEN TC concerned: TC 183	Other: EN 1501-1:1998 + A2:2009; Other clause:
Key words: Refuse collection vehicle (RCV) - riding of operatives		
Question: Under which conditions may lateral facilities (footboards and/or seats) be acceptable for transport of operatives on side loaded RCV's?		
Solution: The facilities for side loaded RCV's must be designed such that the operative is able to enter, to ride on and to exit without exposure to unnecessary risks. Additional to the requirements of EN 1501-1:1998 + A2:2009 and EN 1501-2:2005 + A1:2009 and the Recommendation for use (No CNB/M/06.034/R/E) consideration shall include: <ul style="list-style-type: none"> – entering and leaving the footboards/seats without placing the operatives at risk from moving traffic, – entering and leaving the footboards/seats without placing the operatives at risk from the moving RCV itself, – riding on the footboards/seats with vehicle in motion without placing the operatives at risk from falling, – that lateral facilities outside the width of the RCV are not allowed. Adaptation procedure: FORMAL ADAPTATION IN CONFORMITY WITH DIRECTIVE 2006/42/EC		

(1) Essential safety requirement

Note: According to point 6.6 of the Guide of the implementation of directives based on the New Approach and the Global Approach, the notified bodies apply as general guidance this recommendation for use.

	CO-ORDINATION OF NOTIFIED BODIES Machinery Directive 2006/42/EC + Amendment RECOMMENDATION FOR USE	CNB/M/06.042 Revision 06 Language: E
Date of first stage: Origin: VG6 Refuse collection vehicles	To be approved by: <input checked="" type="checkbox"/> Vertical Group <input checked="" type="checkbox"/> Horizontal Committee To be endorsed by: <input checked="" type="checkbox"/> Machinery Working Group....	Approved on: 16/04/2010 26/11/2009 Endorsed on: 26/05/2010
Question related to: Directive 2006/42/EC Article: Annex: ESR (1): 1.2.1	EN/prEN: EN 1501-1:1998 + A1:2004 + Pr A2:2009 Clause: 6.7.2 CEN TC concerned: TC 183	Other: EN ISO 13849- 1:2008 EN ISO 13849- 2:2004 Other clause: Annex A
Key words: Refuse collection vehicles (RCV) – Performance level		
Question: EN 1501-1:1998 clause 6.7.2 requires for safety related parts of control systems for compaction mechanism, automatic lifting device and automatic mode selection in general category 3 according to EN 954-1. <u>Question regarding the replacement of EN 954-1 by EN ISO 13849-1:2008:</u> Which requirements shall safety related parts of a control fulfil according to EN ISO 13849-1:2008 to reach the same safety level as mentioned in 6.7.2 of EN 1501-1:1998 for the functions mentioned in the Recommended solution.		
Solution: 1. Main function: Compaction mechanism 1.1. Sub-function: Open compaction in semi-automatic mode: start and stop of the open compaction (in the area where distance between packing plate and rave rail is ≤ 500 mm) hold to run-function end position of open compaction (e.g. overriding point) footboard(s) not occupied Access door in closed position 1.1.1. Minimum requirements: PLr "c" and category 3 at the minimum, according to figure 5 of EN ISO 13849-1. 1.1.1.1. Explanations: S 2+ F 1+ P 1 → PLr "C" (according Annex A, figure A.1 EN ISO 13849-1) F 1 because operator is outside the crushing zone during loading, it is very seldom required to enter the dangerous zone only for removing disturbances; P 1 because rcv is operated by professionals movements of compaction mechanism are expected to be slow enough so that escaping is possible.		

(1) Essential safety requirement

Note: According to point 6.6 of the Guide of the implementation of directives based on the New Approach and the Global Approach, the notified bodies apply as general guidance this recommendation for use.

1.2. Sub-function: Automatic compaction – closed system in relation to the flap and the footboards
 (for example) movable flap or lifting device or tipped container creates a closed system
 start and stop of the compaction
 footboard(s) not occupied
 Access door (s) closed

1.2.1. Minimum requirements:

PLr "c" and category 3 at the minimum, according to figure 5 of EN ISO 13849-1.

1.2.1.1. Explanations:

S 2+ F1+ P1 → PLr "C" (according Annex A, figure A.1 EN ISO 13849-1).

1.3. Sub-function: Emptying the hopper (distance between sheartrap and floor

Cleaning function with the compaction mechanism only when the position of the tailgate is $\geq 2,5$ m)

1.3.1.1. Minimum requirements:

PLr "c" and category 3 at the minimum, according to figure 5 of EN ISO 13849-1.

1.3.1.1.1. Explanations:

S 2+ F 1+ P 1 → PLr "C" (according Annex A, figure A.1 EN ISO 13849-1).

2. Automatic lifting device:

2.1. Sub-function: waste container / bin is located (raised to 400 mm)

2.1.1. Minimum requirements: PLr "d" and at the minimum category 3

2.1.1.1. Explanation: S 2+F 2+ P 1→ PLr "d" (according Annex A, figure A.1 EN ISO 13849-1)

F 2 because operator could be inside the crushing zone during loading, P 1 because

- rcv is operated by professionals, movements of the lifting device are expected, escaping is possible.

2.2. Sub-function: start / stop of the lifting device

2.2.1. Minimum requirements: PLr "d" and at the minimum category 3

2.2.1.1. Explanations: S 2 +F 2+P 1→ PLr "d"

2.3. Sub-function: bin (waste container) is locked (in case if monitoring by a switch is necessary, which depends on the design of the lifting device)

2.3.1. Minimum requirements: PLr "d" and at the minimum category 3

2.3.1.1. Explanation: S 2 + F 2 + P 1→ PLr "d"

2.4. Sub-function: position monitoring of mechanical side barriers are extended, release for automatic function

2.4.1. Minimum requirements: PLr "c" and category 2 at the minimum

2.4.1.1. Explanation: S 2+ F 1+ P 1→ PLr "c"

2.5. Sub-function:- non-mechanical side barriers (e.g. light barrier) in function, release for automatic function

2.5.1. Minimum requirements: PLr "c" - at a minimum category 3

2.5.1.1. Explanation: S 2 + F 1 + P 1→ PLr "c"

2.6. Sub-function: footboard(s) not occupied

2.6.1. Minimum requirements: PLr “c” and at the minimum category 3

2.6.1.1. Explanation: S 2 + F 1 + P 1 → PLr “c”

3. Function: mode selection between different lifting device functions (automatic-, semiautomatic-, manual-lifting-cycle)

3.1. Requirements: PLr “d” and at the minimum category 3

3.1.1. Explanation: S 2 + F 2 + P 1 → PLr “d”

4. Function: Emergency stop

4.1. Requirement:

PLr “d”

4.1.1. Explanation: The PL for Emergency stop should be not lower than the highest PL as required for one of all the functions mentioned above

Note:

For every safety related part which is not mentioned in this rfu a risk assessment according to EN ISO 13849-1 has to be made.

Annex:

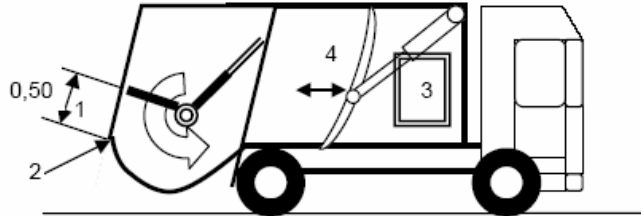

1 = area where compaction only allowed by hold-to-run control
 2 = overriding point
 3 = access door (sheartrap between doorframe and discharge)

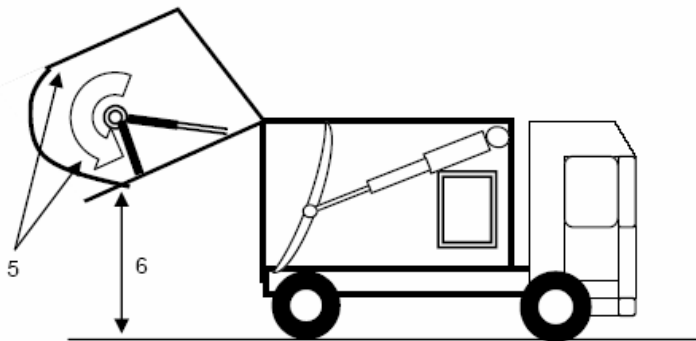

5 = area at the hopper where sheartraps can occur during cleaning function (depends on the kinematics of the compaction mechanism)
 6 = minimum height of 2500 mm of the tailgate (sheartrap) to allow automatic cleaning function

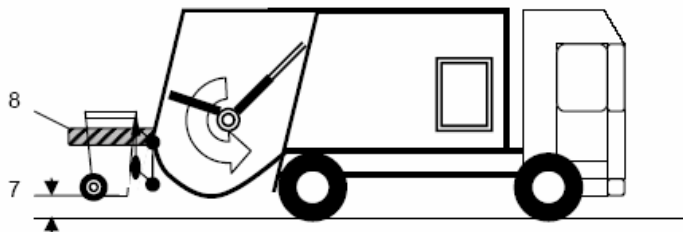

7 = position where bin is raised to 400 mm / located at the receiver
 8 = side barriers in extended position

	CO-ORDINATION OF NOTIFIED BODIES Machinery Directive 2006/42/EC + Amendment RECOMMENDATION FOR USE	CNB/M/06.043 Revision 03 Language: E
Date of first stage: 20/05/2008	To be approved by:	Approved on:
Origin: VG6 Refuse Collection Vehicles	<input checked="" type="checkbox"/> Vertical Group <input checked="" type="checkbox"/> Horizontal Committee To be endorsed by: <input checked="" type="checkbox"/> Machinery Working Group....	20/05/2008 09/12/2008 Endorsed on: 04/07/2012
Question related to: Directive 2006/42/EC Article: 6, 12 Annexes: II, IV ESR (1):	EN/prEN: EN 1501-5:2011, EN1501-1:2011 Clause: CEN TC concerned:	Other: Other clause:
Key words: Element intended to be incorporated / carrying chassis / EC type-examination / EC declaration of conformity		
Question: Which is the scope of the EC type-examination and which is the content of the EC declaration of conformity of a Refuse Collection Vehicle (RCV) installed on a carrying chassis, in the following configurations: <ol style="list-style-type: none"> 1) RCV Annex IV without lifting devices or without predisposition for receiving one or many lifting devices 2) RCV Annex IV with integrated lifting devices 3) RCV Annex IV predisposed for receiving interchangeable lifting devices 		
Solution: <u>Answer to configuration 1):</u> EC type-examination (A) of the RCV, EC declaration of conformity according to Annex II A. and CE marking for the RCV (B) <u>Answer to configuration 2):</u> EC type-examination (A) of the RCV including the lifting device(s), EC declaration of conformity according to Annex II A. and CE marking for the RCV including the lifting device(s) (B) <u>Answer to configuration 3):</u> EC type-examination (A) of the RCV with its predispositions for receiving an interchangeable lifting device which is compatible with the RCV *, both manufacturers have to deliver their own declaration of conformity (for RCV declaration of conformity (II A) and lifting device declaration of conformity (II A) as an interchangeable equipment. (A): EC type-examination and EC type-certificate issued by a Notified Body; this EC type-certificate makes a copy of the conclusions of the EC type-examination and mentions the conditions and the limitations which restrict the extent of the documents, e.g. minimal width of the chassis to allow mounting of footboards. (B): Placing on the market of the RCV: EC declaration of conformity according to Annex II A. and CE marking are of the responsibilities of the manufacturer * Note: The compatibility is given if the manufacturer of the lifting device and the manufacturer of the RCV use a defined interface (hydraulically, pneumatically, electrically and mechanically), e. g. an interface according to EN 1501-5:2011		

(1) Essential safety requirement

Note: According to point 6.6 of the Guide of the implementation of directives based on the New Approach and the Global Approach, the notified bodies apply as general guidance this recommendation for use.

	CO-ORDINATION OF NOTIFIED BODIES Machinery Directive 2006/42/EC as amended RECOMMENDATION FOR USE		CNB/M/06.045 Revision : 03 Language : EN
Number of pages :	Date : 2013-04-23	To be approved by :	Approved on :
Origin : VG 6 Refuse collection vehicles		<input type="checkbox"/> Vertical Group <input checked="" type="checkbox"/> Horizontal Committee	09/04/2014 18/06/2014 Endorsed on : 23/09/2016
Question related to : Directive 2006/42/EC	Article : Annex : EHSR (1) : 1.2.2	To be endorsed by : EN/pren : EN1501-1:2011 Normative clause : 5.2.4.1 CEN TC concerned : CEN TC183	Other : - Other clause : -
Key words: Refuse collection vehicle (RCV) - compaction start			
<p>Activation of the automatic compaction mode requires an impulse command, e. g. by a start control device located at the rear working stations or by the lifting device command.</p> <p>Question: Are there other conditions which allow to restart the automatic compaction after interruption of the automatic compaction?</p>			
<p>Recommended solution:</p> <p>Yes a restart after interruption of the automatic compaction can be allowed under the following conditions:</p> <ul style="list-style-type: none"> - this mode has to be activated by a special control placed at the rear working station(s) - before restart a clear identifiable acoustical or visual warning signal will be given to the operators, standing at the rear / on the footboard(s) 3 seconds before the starting impulse. <p>together with <u>one</u> of the following 3 options:</p> <p><u>1st option</u></p> <ul style="list-style-type: none"> - closed system according 3.16.2 of EN 1501-1 from the footboard position is given and closed system according 3.16.2 of EN 1501-1 from the ground is given - footboard(s) is (are) situated beside the hopper opening - lateral guards between footboard(s) and hopper, which prevent access from footboard to the hopper (or bypassing) are fitted 			

Note : According to point 6.6 of the Guide of the implementation of directives based on the New Approach and the Global Approach, the notified bodies apply as general guidance this recommendation for use.

Sent for information to: members of the VG other(s) VG HC (2) TC (3) SC (4)

(1) Essential Health and Safety Requirement (3) N° of CEN/TC (Secretary & Chairman)

(5) To be specified

(2) Horizontal Committee

(4) Machinery Working Group

- a light barrier at the rave rail which is detecting persons passing the rave rail (SPE)

2nd option:

- both footboards have to be left within a timeframe of maximum of 2 seconds and the start impulse shall start the compaction cycle within a minimum of 1 second and a maximum of 2 seconds after both footboards (if they have been occupied) have been left.

3rd option:

- if footboards have not been occupied or the start impulse have not been given within minimum of 1 second and maximum of 3 seconds,
then a light barrier at the rave rail detecting persons passing the rave rail (SPE) has been provided, to prevent the compaction cycle
when a person is detected. Manual restart of that function after detection of a person is required.

Annex:

example for 1st option:

explanation: access to the compaction mechanism is not possible if operative is standing on the footboard due to distance given by the lateral cover of the lifting device.



	<p>CO-ORDINATION OF NOTIFIED BODIES Machinery Directive 2006/42/EC + Amendment</p> <p>RECOMMENDATION FOR USE</p>	<p>CNB/M/08.001 Revision 04</p> <p>Language: E</p>
<p>Date of first stage: 23/06/1997</p>	<p>To be approved by:</p>	
<p>Origin: VG8 Vehicles servicing lifts</p>	<p><input checked="" type="checkbox"/> Vertical Group</p> <p><input checked="" type="checkbox"/> Horizontal Committee</p> <p>To be endorsed by:</p> <p><input checked="" type="checkbox"/> Machinery Working Group....</p>	<p>Approved on:</p> <p>12/04/2010 13/12/1995</p> <p>Endorsed on: 04/06/1996</p>
<p>Question related to: Directive 2006/42/EC Article:</p> <p>Annex: ESR (1):</p>	<p>EN/prEN: pr EN 1493 Other:</p> <p>Clause: 5.6.5.6 Other clause:</p> <p>GEN TC concerned: TC 98 WG 2</p>	
<p>Key words: Polyamide Nuts</p>		
<p>Question: With regard to screw drives red brass or bronze are the most common materials for the load bearing nut and the safety nut as written in the comments of the German prevention rule VBG 14. However, some manufacturers intend to use polyamide for the load bearing nut. Some tests in our institute have shown that polyamide nuts can have the same or even a better tribological behaviour than bronze nuts, e.g. with regard to self-locking and self-retarding. Is it allowed to use polyamide nuts in vehicle lifts? Do the other NB's have any experiences with these nuts, especially when the lubricant is contaminated with dirt or particles (e.g. swarf)?</p>		
<p>Solution:</p> <p>Polyamide nuts may be used in vehicle lifts, provided that lifetime tests have been carried out. The technical should</p> <ul style="list-style-type: none"> • describe the conditions for this test which should include • carrying out min. 30000 load cycles (nominal load), which relates to a life time of 10 years. <p>A safety factor of 6 against breaking shall be used.</p> <p>Adaptation procedure: FORMAL ADAPTATION IN CONFORMITY WITH DIRECTIVE 2006/42/EC</p>		

(1) Essential safety requirement

Note: According to point 6.6 of the Guide of the implementation of directives based on the New Approach and the Global Approach, the notified bodies apply as general guidance this recommendation for use.

	<p>CO-ORDINATION OF NOTIFIED BODIES Machinery Directive 2006/42/EC + Amendment</p> <p>RECOMMENDATION FOR USE</p>	<p>CNB/M/08.002 Revision 04</p> <p>Language: E</p>
Date of first stage: 24/05/2000	To be approved by:	Approved on:
Origin: VG8 Vehicles servicing lifts	<input checked="" type="checkbox"/> Vertical Group <input checked="" type="checkbox"/> Horizontal Committee	<p>12/04/2010 09/12/1998</p>
<p>Question related to: Directive 2006/42/EC Article:</p> <p>Annex: ESR (1):</p>	<p>EN/prEN:</p> <p>Clause:</p> <p>CEN TC concerned:</p>	<p>Other:</p> <p>Other clause:</p>
Key words: EC Type Test		
<p>Question:</p> <p>How do we proceed, when the EC-type test refers to a group of machines (vehicle lifts) with the same design features and merely different load-carrying capacities? Do we have to test each machine (vehicle lift) or is it sufficient to test the type with minimum and/or maximum bearing capacity?</p>		
<p>Solution:</p> <p>Each type of vehicle lift has to be tested and compliance with the ESR'S of MD has to be confirmed by the NB. The extent of test can be reduced in case of similar equipment by responsibility of the NB. (see also CNB/M/03.009)</p> <p>Adaptation procedure: FORMAL ADAPTATION IN CONFORMITY WITH DIRECTIVE 2006/42/EC</p>		

(1) Essential safety requirement

Note: According to point 6.6 of the Guide of the implementation of directives based on the New Approach and the Global Approach, the notified bodies apply as general guidance this recommendation for use.

	CO-ORDINATION OF NOTIFIED BODIES Machinery Directive 2006/42/EC + Amendment RECOMMENDATION FOR USE	CNB/M/08.003 Revision 05 Language: E
Date of first stage: 24/05/2000	To be approved by:	Approved on:
Origin: VG8 Vehicles servicing lifts	<input checked="" type="checkbox"/> Vertical Group	12/04/2010
	<input checked="" type="checkbox"/> Horizontal Committee	09/12/1998
Question related to: Directive 2006/42/EC Article: Annex: ESR (1):	To be endorsed by:	Endorsed on:
	<input checked="" type="checkbox"/> Machinery Working Group....	03/03/2000
Key words: instruction handbook, check	EN/prEN: EN ISO 12100-2:2003	Other:
Question: Is it necessary within the EC-type test to examine the content of the instruction handbook in detail or is it sufficient to check the handbook only in a formal way e.g. with regard to chapter 6 of EN 12100-2:2003?	Clause:	Other clause:
	CEN TC concerned:	
	Solution: Notified bodies shall examine the safety relevant content of the instruction handbook (content see EN 12100-2 clause 6). Details for vehicle lifts are e.g. (see next page).	
Adaptation procedure: FORMAL ADAPTATION IN CONFORMITY WITH DIRECTIVE 2006/42/EC		

(1) Essential safety requirement

Note: According to point 6.6 of the Guide of the implementation of directives based on the New Approach and the Global Approach, the notified bodies apply as general guidance this recommendation for use.

Details for vehicle lifts (cont.)

- Information about the product:
 - name of manufacturer, importer or dealer,
 - type designation of product,
 - date of issue of the instruction manual, status,
 - address of manufacturer, address of authorized representative,
 - technical ratings of the vehicle lift (load, load distribution, height),
 - intended use (lifting of cars), inappropriate use (lifting of people), special applications
 - available equipment options (wheel free systems, alignment systems),
 - weight and dimensions,
 - special properties (e.g. Ex proof),
 - noise and other emissions.
- Information about installation:
 - limitations of environmental ambient conditions (temperature, humidity, water),
 - required floor conditions (strength, preparation),
 - electrical supply requirements (voltage, current, supply cable size, starting current, fusing),
 - hydraulic supply requirements (max. pressure, oil quality and amounts),
 - pneumatic supply requirements (max. pressure),
 - means the user has to provide (power system, mains switch, guards),
 - final checks.
- Information about the use
 - description of controls (raising, lowering),
 - description of safety devices (safety catch, levelling system, emergency stop, rope or chain failure),
 - adjustment procedures (if any),
 - emergency stop procedures, restarting.
 - operating modes (independent / common control), safety features in different operating modes,
 - protection against unauthorized use (use of key switches),
 - rules for handling of special conditions (after tripping of protective devices, emergency lowering)
 - warning of dangerous parts (high voltage, high pressure),
 - error handling procedures (tripping of fuses, desynchronisation),
 - charging of batteries (ventilation),
 - safety instructions (e.g. no persons under the lift during movement),
 - authorization for operating.
- Maintenance and repair
 - necessary spare parts,
 - service intervals,
 - special safety precautions during maintenance and repair,
 - safety inspections and tests.
- User information
 - parts lists (electrical, hydraulic, pneumatic),
 - schematics (electrical, hydraulic, pneumatic),
 - pictures, photos, exploded view

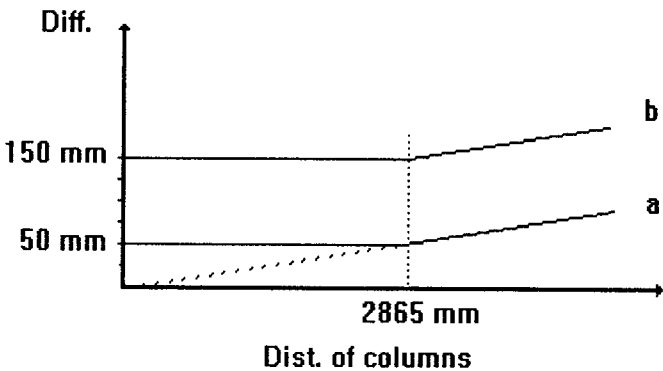
	<p>CO-ORDINATION OF NOTIFIED BODIES Machinery Directive 2006/42/EC + Amendment</p> <p>RECOMMENDATION FOR USE</p>	<p>CNB/M/08.004 Revision 05</p> <p>Language: E</p>
<p>Date of first stage: 25/10/1996</p>	<p>To be approved by:</p>	<p>Approved on:</p>
<p>Origin: VG8 Vehicles servicing lifts</p>	<p><input checked="" type="checkbox"/> Vertical Group</p> <p><input checked="" type="checkbox"/> Horizontal Committee</p> <p>To be endorsed by:</p> <p><input checked="" type="checkbox"/> Machinery Working Group....</p>	<p>12/04/2010</p> <p>17/04/1996</p> <p>Endorsed on:</p> <p>08/06/1998</p>
<p>Question related to: Directive 2006/42/EC Article:</p> <p>Annex: ESR (1):</p>	<p>EN/prEN: EN 1493:1998</p> <p>Clause: 5.14</p> <p>CEN TC concerned: TC 98 WG 2</p>	<p>Other:</p> <p>Other clause:</p>
<p>Key words: unintentional desynchronisation during operation</p>		
<p>Question:</p> <p>What measures have to be taken against unintentional desynchronisation during operation?</p>		
<p>Solution:</p> <p>Errors in logic shall not lead to dangerous situations Interruption, re-establishment after an interruption or fluctuation in whatever manner of the power supply must not lead to a dangerous situation It shall be ensured that the vehicle stays horizontally, even if it is supported by two or more drives or bearing devices.</p> <p>Unintentional desynchronisation may lead to an overload of one or more drives, if one or more drives do not longer support the load. Furthermore it may cause tilting of the supported vehicle.</p> <p>Note:</p> <ol style="list-style-type: none"> Synchronisation may be accomplished by using: <ul style="list-style-type: none"> - mechanical devices (ropes, chains, poles), - hydraulical circuits, - electrical controls (not considered to be a safety device). The maximum allowed tilt is 50 mm or 1° (may be more than 50 mm); see picture, line a. <div style="text-align: center;">  <p>The graph plots 'Diff.' on the vertical axis and 'Dist. of columns' on the horizontal axis. Two lines, 'a' and 'b', are shown. Line 'a' is a solid horizontal line at a difference of 50 mm. Line 'b' is a solid line that starts at a difference of 150 mm and increases linearly as the distance of columns increases. A vertical dashed line is drawn at a distance of 2865 mm. The horizontal axis is labeled 'Dist. of columns' and the vertical axis is labeled 'Diff.'.</p> </div>		

(1) Essential safety requirement

Note: According to point 6.6 of the Guide of the implementation of directives based on the New Approach and the Global Approach, the notified bodies apply as general guidance this recommendation for use.

2. In case of rupture of drives, ropes, chains, nuts or gears or leakage in the hydraulic or pneumatic line an additional 100 mm difference is permitted; see picture line b. If the synchronisation is performed using an electrical central or a hydraulically circuit, an additional safety central has to stop the movement of the vehicle lift, unless the proper synchronisation has been restored using other measures.
3. Electrical (or electronical) safety controls must store the amount of unsynchronisation regardless of voltage drop, power failure and power return. Otherwise multiple power off and on may lead to unintended tilt angles more than allowed.
4. Safety categories
Safety related parts in electrical synchronisation devices shall be in accordance with EN 954-1:1996 category 2.

**Adaptation procedure: FORMAL ADAPTATION IN CONFORMITY WITH
DIRECTIVE 2006/42/EC**

	<p>CO-ORDINATION OF NOTIFIED BODIES Machinery Directive 2006/42/EC + Amendment</p> <p>RECOMMENDATION FOR USE</p>		<p>CNB/M/08.007 Revision 03</p> <p>Language: E</p>
<p>Date of first stage: 25/10/1996</p>	<p>To be approved by:</p>	<p>Approved on:</p>	
<p>Origin: VG8 Vehicles servicing lifts</p>	<p><input checked="" type="checkbox"/> Vertical Group</p> <p><input checked="" type="checkbox"/> Horizontal Committee</p>	<p>12/04/2010 17/04/1996</p>	<p>To be endorsed by:</p> <p><input checked="" type="checkbox"/> Machinery Working Group....</p> <p>Endorsed on: 08/06/1998</p>
<p>Question related to: Directive 2006/42/EC</p>	<p>Article:</p>	<p>EN/prEN: pr EN 1493 N12</p>	<p>Other:</p>
<p>Annex:</p>	<p>ESR (1):</p>	<p>Clause: 5.6.6, 5.6.2.1</p>	<p>Other clause:</p>
<p>GEN TC concerned: TC 98 WG 2</p>			
<p>Key words: Horizontal Forces</p>			
<p>Question: Loading system for motor bike lifts.</p>			
<p>Solution: A general horizontal force of 1000 N from manipulation on vehicles is required in prEN 1493. This force is not applicable on motor bikes (self weight between 800 N and 4200 N) without pushing the bikes from the lift and should be reduced, taking into account the nominal load of the lift. It is proposed to apply for the horizontal forces on motor bike lifts 10% of the nominal load, but min. 300 N.</p> <p>Adaptation procedure: FORMAL ADAPTATION IN CONFORMITY WITH DIRECTIVE 2006/42/EC</p>			

(1) Essential safety requirement

Note: According to point 6.6 of the Guide of the implementation of directives based on the New Approach and the Global Approach, the notified bodies apply as general guidance this recommendation for use.

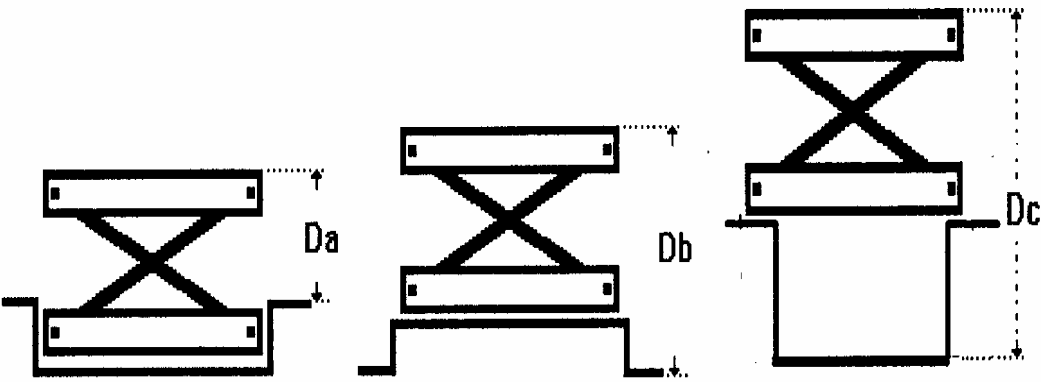
	<p>CO-ORDINATION OF NOTIFIED BODIES Machinery Directive 2006/42/EC + Amendment</p> <p>RECOMMENDATION FOR USE</p>	<p>CNB/M/08.011 Revision 03</p> <p>Language: E</p>
Date of first stage: 25/10/1996	To be approved by:	Approved on:
Origin: VG8 Vehicles servicing lifts	<input checked="" type="checkbox"/> Vertical Group <input checked="" type="checkbox"/> Horizontal Committee	12/04/2010 17/04/1996
	To be endorsed by:	Endorsed on:
Question related to: Directive 2006/42/EC Article: Annex: ESR (1):	EN/prEN: pr EN 1493 N12 Clause: 3.1 CEN TC concerned: TC 98 WG 2	Other: Other clause:
Key words: Short stroke lifts - Definition		
Question: How is the lifting height defined?		
Solution:		
The lifting height is defined by the standing area of the user and the position of the lift related to the user (see examples below).		
		
<p>Adaptation procedure: FORMAL ADAPTATION IN CONFORMITY WITH DIRECTIVE 2006/42/EC</p>		

(1) Essential safety requirement

Note: According to point 6.6 of the Guide of the implementation of directives based on the New Approach and the Global Approach, the notified bodies apply as general guidance this recommendation for use.

	<p style="text-align: center;">CO-ORDINATION OF NOTIFIED BODIES Machinery Directive 2006/42/EC + Amendment</p> <p style="text-align: center;">RECOMMENDATION FOR USE</p>		<p>CNB/M/08.015 Revision 03</p> <p>Language: E</p>
<p>Date of first stage: 13/11/2000</p>	<p>To be approved by:</p>		<p>Approved on:</p>
<p>Origin: VG8 Vehicles servicing lifts</p>	<p><input checked="" type="checkbox"/> Vertical Group</p> <p><input checked="" type="checkbox"/> Horizontal Committee</p> <p>To be endorsed by:</p> <p><input checked="" type="checkbox"/> Machinery Working Group....</p>		<p>12/04/2010 11/12/2003</p> <p>Endorsed on: 01/07/2004</p>
<p>Question related to: Directive 2006/42/EC Article:</p> <p>Annex: ESR (1):</p>	<p>EN/prEN: EN 1493:1998 Clause: 5.16.3 GEN TC concerned: TC 98 WG 2</p>		<p>Other: Other clause:</p>
<p>Key words: Rails, foot protectors, protection against pinching points</p>			
<p>Question: How shall foot protectors to be designed?</p>			
<p>Solution:</p> <p>The design shall take into account that a person may step on it in the ground position, without losing its safety function. It does not to be designed to withstand an obstruction when lowering.</p> <p>Adaptation procedure: FORMAL ADAPTATION IN CONFORMITY WITH DIRECTIVE 2006/42/EC</p>			

(1) Essential safety requirement

Note: According to point 6.6 of the Guide of the implementation of directives based on the New Approach and the Global Approach, the notified bodies apply as general guidance this recommendation for use.

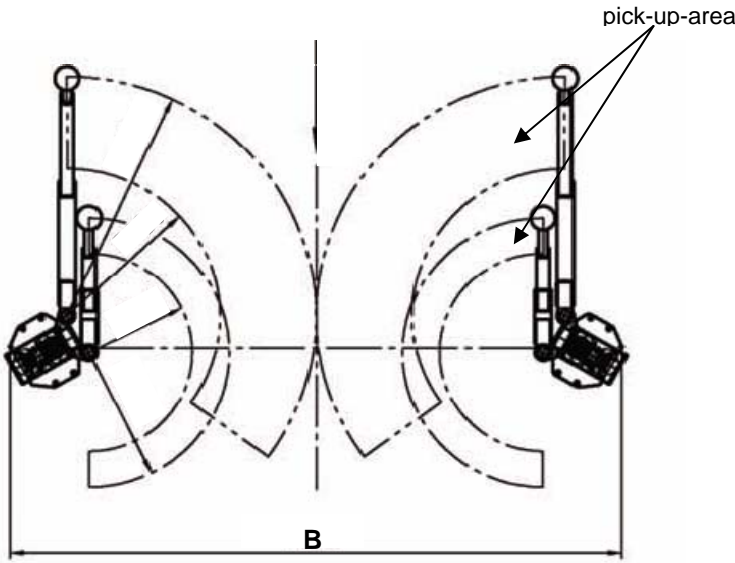
	<p>CO-ORDINATION OF NOTIFIED BODIES Machinery Directive 2006/42/EC + Amendment</p> <p>RECOMMENDATION FOR USE</p>	<p>CNB/M/08.018 Revision 05</p> <p>Language: E</p>
<p>Date of first stage: 06/12/2011</p> <p>Origin: VG8 Vehicles servicing lifts</p>	<p>To be approved by:</p> <p><input checked="" type="checkbox"/> Vertical Group</p> <p><input checked="" type="checkbox"/> Horizontal Committee</p> <p>To be endorsed by:</p> <p><input checked="" type="checkbox"/> Machinery Working Group....</p>	<p>Approved on:</p> <p>25/04/2013</p> <p>26/06/2013</p> <p>Endorsed on:</p> <p>22/11/2013</p>
<p>Question related to: Directive 2006/42/EC Article:</p> <p>Annex: I ESR (1): 1.1.2.</p>	<p>EN/prEN: EN 1493:2010</p> <p>Clause: 5.7.4.3. a) and b)</p> <p>CEN TC concerned: CEN TC 98</p>	<p>Other:</p> <p>Other clause:</p>
<p>Key words: Load distribution on two post lifts with load-bearing arms</p>		
<p>Question:</p> <p>Is it necessary for two post lifts, where both arms of one column could swing in the same direction, to consider this position for the stability and strengths calculation?</p> <p>Has the manufacture take into account such a manner of use as normal use ore as foreseeable misuse in accordance with the machinery directive section 1.1.2. annex 1.</p>		
<p>Situation:</p> <p>The standard requires that the long arms must be in the maximum telescoped position with a width of 1 m of the pick-up points. The short arms should be "in the position which gives the worst condition".</p> <p>Normally, vehicles are raised so that the center of gravity is close to the connecting line between the two lifting columns.</p> <p>But there are many vehicle servicing lifts where it is possible to raise a vehicle with all four arms pivoted in the same direction (see figure 1).</p> <p>Especially at asymmetric two post lifts or lifts with double swing arms, it is possible, to reach such a position and to lift vehicles.</p> <div style="text-align: center;">  </div> <p>Figure 1 asymmetric post lift</p>		

(1) Essential safety requirement

Note: According to point 6.6 of the Guide of the implementation of directives based on the New Approach and the Global Approach, the notified bodies apply as general guidance this recommendation for use.

Do to the position centre of gravity of the load the bending moment is significantly larger than during pick up a vehicle in a central position where the arms of the post are pivoted in different directions. Due to the very different design of the mounting points of the various vehicles and the differences in design of the lifts, it is very difficult to assess which vehicles can be lifted in detail. The practice shows, that especially smaller cars can be lifted in such a position.

Solution:

The answer to both questions is yes. Since it is possible to lift cars in this position and the standard requires in 5.7.4.3 a) and b):

"On vehicle lifts with carrying arms the rated load shall be distributed on the four corners of a rectangle with the dimensions of 100 cm (width) with the maximum load at the maximum length of the longest arm and the short arm in the position which gives the worst condition."

The manufacturer has to consider this position in the safety design of its vehicle lift.

VG 8 sees two basic approaches:

- prevention of lifting in such a position (for example, by limiting the swiveling range of the arms, a safety device prevents a lifting movement in this position or a load moment limiting device)
- sufficient stability and attachment of the vehicle lift, so that the rated load can be lifted safely also in this position

Calculation - permissible stresses

The normal values of permissible stresses are given in Annex A of EN 1493:2010. A safety factor of 1,5 must be achieved.

In view of the situation, that in this position usually only smaller vehicles can be lifted, which do not reach the rated load of the lift, it is acceptable in that case to reduce the safety factors for the calculation of stability and strength.

Under the most unfavorable loading conditions - all four arms on one side of the lift, long arms in maximum ejection position, pick up points in wheel track direction 1m distance, pick up points in wheelbase direction 1m distance, rated load according section 5.7.4.3 a) and b) at least a minimum safety factor of 1,2 is acceptable. The vehicle lift has to be sufficiently strong and stable during movement of the load. In that case an additional warning label on the lift and a appropriate note in the user manual shall include the prohibition of the use in this position

In the position distance in wheelbase direction 1,4m (normative rectangle) a safety factor of 1,5 must be kept.

If the use of the lift in this way (four arms in one direction) is approved by the manufacturer, a reduction of lift capacity in this position by labeling is not allowed.

	CO-ORDINATION OF NOTIFIED BODIES Machinery Directive 2006/42/EC + Amendment RECOMMENDATION FOR USE	CNB/M/09.206 Revision 04 Language: E
Date of first stage: 02/04/2003	To be approved by:	
Origin: VG9 Lifting persons device (LPD)	<input checked="" type="checkbox"/> Vertical Group <input checked="" type="checkbox"/> Horizontal Committee	Approved on: 13/04/2010 11/12/2003
		To be endorsed by:
Question related to: Directive 2006/42/EC Article: 12 (3) Annex: IX ESR (1):		EN/prEN: Other: Clause: Other clause: CEN TC concerned:
Key words: Lifting Persons Device (LPD), Suspended Access Equipment, modular construction, certification		
Question: Is it possible to certify the modules of a Suspended Access Equipment separately, provided the limits of application and conditions of use are clearly laid down?		
<p>Solution:</p> <p>NO "Temporary Suspended Platforms" designed on a modular basis in order to allow actual installations to be easily configured according to the needs on site can only be certified as a complete machine. It's up to the negotiation between the applicant and the NB to define which configuration of the machine represents in the best way all possibilities and which is then subject of the type examination procedure. The manufacturers instructions, the examination of which is part of the EC type-examination, must contain in detail descriptions which modules can be combined and how that has to be done to allow different configurations. A positive passing of the EC type-examination then leads to <u>one</u> certificate of the tested configuration including all possible combinations, described in the instructions. A modification of a module/component or the addition of a new one requires information from the manufacturer to the NB having issued the certificate and which has to decide, whether this modification needs renewal of the certificate or not.</p> <p>The idea, to regard all modules/components as interchangeable equipment and certify them independently, was not taken as an appropriate method of certification for these wishes of manufacturers to be more flexible.</p> <p>Adaptation procedure: FORMAL ADAPTATION IN CONFORMITY WITH DIRECTIVE 2006/42/EC</p>		

(1) Essential safety requirement

Note: According to point 6.6 of the Guide of the implementation of directives based on the New Approach and the Global Approach, the notified bodies apply as general guidance this recommendation for use.

	<p>CO-ORDINATION OF NOTIFIED BODIES Machinery Directive 2006/42/EC + Amendment</p> <p>RECOMMENDATION FOR USE</p>	<p>CNB/M/09.207 Revision 10</p> <p>Language: E</p>	
Date of first stage: 17/07/1998	To be approved by:		
Origin: VG9 Lifting persons device (LPD)	<input checked="" type="checkbox"/> Vertical Group <input checked="" type="checkbox"/> Horizontal Committee	<p>Approved on:</p> <p>13/04/2010 26/11/2009</p>	
		<p>To be endorsed by:</p> <input checked="" type="checkbox"/> Machinery Working Group....	
Question related to: Directive 2006/42/EC	Article:	EN/prEN:	Other:
Annex: IV	ESR (1):	Clause:	Other clause:
		CEN TC concerned:	
Key words: Type-examination			
Question: What is the range of an EC type-examination for a machine, where the lifting of persons is not the primary function?			
Solution:			
In the minutes of the 167 1st meeting of the Council (internal market) held on 1993-06-14 it is stated:			
“The Council and the Commission agree that the type examination of a device for the lifting of persons shall be limited to the lifting device itself and not to the complete machine which includes the lifting device.”			
VG9 understands this statement as follows:			
<ul style="list-style-type: none"> • In the case of interchangeable equipment the handling is explained in the Commission document: “Interchangeable equipment for lifting persons and equipment used with machinery designed for lifting goods for the purpose of lifting persons” available on the EUROPA website: http://ec.europa.eu/enterprise/sectors/mechanical/documents/guidance/machinery/index_en.htm • In case of an integral part of a machine, besides the examination and tests of the lifting appliance itself the EC type-examination has to include also those functions, components or aspects of the whole machine, the operation or malfunction of which affect the safety of lifted persons. 			

(1) Essential safety requirement

Note: According to point 6.6 of the Guide of the implementation of directives based on the New Approach and the Global Approach, the notified bodies apply as general guidance this recommendation for use.

	CO-ORDINATION OF NOTIFIED BODIES Machinery Directive 2006/42/EC + Amendment RECOMMENDATION FOR USE	CNB/M/09.209 Revision 04 Language: E
Date of first stage: 02/04/2003	To be approved by:	
Origin: VG9 Lifting persons device (LPD)	<input checked="" type="checkbox"/> Vertical Group <input checked="" type="checkbox"/> Horizontal Committee	Approved on: 13/04/2010 11/12/2003
		To be endorsed by: <input checked="" type="checkbox"/> Machinery Working Group....
Question related to: Directive 2006/42/EC	Article:	EN/prEN:
Annex: VI	ESR (1):	Other:
		Clause:
		Other clause:
		CEN TC concerned:
Key words: EC type-examination, work platform, loader crane		
Question: What is the scope of a EC type-examination of a work platform installed on the boom of a loader crane on a vehicle?		
Solution:		
<p>In this case the notified body shall check conformity <u>of the entire device</u> for lifting persons constituted by the work platform, the loader crane and the supporting chassis with the Essential Health and Safety Requirements (EHSRs) of the directive 2006/42/EC (in particular: resistance, stability, control of the placing of the stabilisers).</p>		
<p>If the platform is designed for use on several models of cranes the EC type-examination certificate shall list the models concerned. The certificate shall also state the models of supporting chassis on which the conformity of the Lifting Persons device has been checked.</p>		
<h2>Adaptation procedure: FORMAL ADAPTATION IN CONFORMITY WITH DIRECTIVE 2006/42/EC</h2>		

(1) Essential safety requirement

Note: According to point 6.6 of the Guide of the implementation of directives based on the New Approach and the Global Approach, the notified bodies apply as general guidance this recommendation for use.

	CO-ORDINATION OF NOTIFIED BODIES Machinery Directive 2006/42/EC + Amendment RECOMMENDATION FOR USE	CNB/M/09.305 Revision 06 Language: E
Date of first stage: 06/03/1998	To be approved by:	
Origin: VG9 Lifting persons device (LPD)	<input checked="" type="checkbox"/> Vertical Group <input checked="" type="checkbox"/> Horizontal Committee	Approved on: 13/04/2010 11/06/1998
		To be endorsed by: <input checked="" type="checkbox"/> Machinery Working Group....
Question related to: Directive 2006/42/EC	Article:	EN/prEN:EN 280:2001+A2:2008 Other:
Annex: I	ESR (1): 6.3.2	Other clause:
Clause: 5.6.1		Other clause:
CEN TC concerned:		
Key words: Mobile Elevated Workplatform (MWEF), levelling system		
Question: Is in addition to the levelling system (mechanical or hydraulic) a manual adjustment of the platform level acceptable, which may cause a platform level or more than 5° ?		
Solution: Yes, provided that in a master-slave levelling system and in an independent hydraulic or mechanical levelling system a manual adjustment is speed limited to 0,5°/s.		
<h2>Adaptation procedure: FORMAL ADAPTATION IN CONFORMITY WITH DIRECTIVE 2006/42/EC</h2>		

(1) Essential safety requirement

Note: According to point 6.6 of the Guide of the implementation of directives based on the New Approach and the Global Approach, the notified bodies apply as general guidance this recommendation for use.

	CO-ORDINATION OF NOTIFIED BODIES Machinery Directive 2006/42/EC + Amendment RECOMMENDATION FOR USE	CNB/M/09.306 Revision 05 Language: E
Date of first stage: 06/03/1998	To be approved by:	
Origin: VG9 Lifting persons device (LPD)	<input checked="" type="checkbox"/> Vertical Group <input checked="" type="checkbox"/> Horizontal Committee	Approved on: 13/04/2010 11/06/1998
		To be endorsed by: <input checked="" type="checkbox"/> Machinery Working Group....
Question related to: Directive 2006/42/EC	Article:	EN/prEN:EN 280:2001+A2:2008 Other:
Annex: I	ESR (1): 6.3.2	Clause: 5.6.1 Other clause:
GEN TC concerned:		
Key words: Mobile Elevated Workplatform (MWEPE), levelling system		
Question: : Is in case of a hydraulic levelling system (master - slave principle) a safety device (other than lock valves) required, which stops the movement of the extending structure in case of hose failure of the master-slave hydraulic circuit, when the level of the platform exceeds 10° ?		
Solution:		
No. Levelling systems using the master - slave principle and being equipped with lock valves do not cause an unintended movement in case of hose failure and locks the platform.		
Adaptation procedure: FORMAL ADAPTATION IN CONFORMITY WITH DIRECTIVE 2006/42/EC		

(1) Essential safety requirement

Note: According to point 6.6 of the Guide of the implementation of directives based on the New Approach and the Global Approach, the notified bodies apply as general guidance this recommendation for use.

	<p>CO-ORDINATION OF NOTIFIED BODIES Machinery Directive 2006/42/EC + Amendment</p> <p>RECOMMENDATION FOR USE</p>	<p>CNB/M/09.307 Revision 04</p> <p>Language: E</p>
<p>Date of first stage: 28/04/1999</p>	<p>To be approved by:</p>	<p>Approved on:</p>
<p>Origin: VG9 Lifting persons device (LPD)</p>	<p><input checked="" type="checkbox"/> Vertical Group</p> <p><input checked="" type="checkbox"/> Horizontal Committee</p> <p>To be endorsed by:</p> <p><input checked="" type="checkbox"/> Machinery Working Group....</p>	<p>13/04/2010</p> <p>24/05/2000</p> <p>Endorsed on:</p> <p>09/04/2001</p>
<p>Question related to: Directive 2006/42/EC Article: Annex: I ESR (1): 6.3.1</p>	<p>EN/prEN: Clause: GEN TC concerned:</p>	<p>Other: Other clause:</p>
<p>Key words: Lifting Persons Device, safety gear</p>		
<p>Question: Do lifting persons device with positive driving units need safety gears ?</p>		
<p>Solution:</p> <p>It is a general rule, that uncontrolled movements of the load carrying unit of LPD due to wear or failure in the driving unit need to be avoided. Appropriate means are overspeed governed safety gears, rupture valves, lock valves, redundant drive units, safety nuts etc. Standards for LPD address these means. Design of a driving unit taking into account factors to increase the loads and forces to be taken by them is not regarded as appropriate measure against uncontrolled movement.</p> <p>Adaptation procedure: FORMAL ADAPTATION IN CONFORMITY WITH DIRECTIVE 2006/42/EC</p>		

(1) Essential safety requirement

Note: According to point 6.6 of the Guide of the implementation of directives based on the New Approach and the Global Approach, the notified bodies apply as general guidance this recommendation for use.

	CO-ORDINATION OF NOTIFIED BODIES Machinery Directive 2006/42/EC + Amendment RECOMMENDATION FOR USE	CNB/M/09.309 Revision 04 Language: E
Date of first stage: 28/04/1999	To be approved by:	Approved on:
Origin: VG9 Lifting persons device (LPD)	<input checked="" type="checkbox"/> Vertical Group <input checked="" type="checkbox"/> Horizontal Committee	13/04/2010 24/05/2000
	To be endorsed by:	Endorsed on:
	<input checked="" type="checkbox"/> Machinery Working Group....	09/04/2001
Question related to: Directive 2006/42/EC Annex: I, IV	Article: ESR (1): 1.1.2, 1.6.2, 6.3.2	EN/prEN:EN 280:2001+A2:2008 Other: Clause: 5.6.3 Other clause: CEN TC concerned:
Key words: Mobile Elevated Work Platform, MEWP, access, movable guard, abnormal use		
Question: Is it acceptable to use manually liftable bars returning into the safeguarding position by gravity as means as protection at the access to work platforms ?		
Solution: Yes. The possibility of deliberate fixing in the open position of protection means at the access to work platforms needs not to be regarded as abnormal use which has to be prevented by construction.		
Adaptation procedure: FORMAL ADAPTATION IN CONFORMITY WITH DIRECTIVE 2006/42/EC		

(1) Essential safety requirement
Note: According to point 6.6 of the Guide of the implementation of directives based on the New Approach and the Global Approach, the notified bodies apply as general guidance this recommendation for use.

	CO-ORDINATION OF NOTIFIED BODIES Machinery Directive 2006/42/EC + Amendment RECOMMENDATION FOR USE	CNB/M/09.310 Revision 05 Language: E
Date of first stage: 28/04/1999	To be approved by:	Approved on:
Origin: VG9 Lifting persons device (LPD)	<input checked="" type="checkbox"/> Vertical Group	13/04/2010
	<input checked="" type="checkbox"/> Horizontal Committee	24/05/2000
Question related to: Directive 2006/42/EC Article: Annex: I ESR (1): 4.1.2.4, 6.1.2	EN/prEN:	Other:
	Clause:	Other clause:
	CEN TC concerned:	
Key words: Man rider winches, one rope suspension		
Question: Is it acceptable to use one-rope suspension in person lifting device?		
<p>Solution:</p> <p>At silo access equipment and man rider winches doubled suspension elements create hazards which are not acceptable, e. g. twisting, entanglement, etc. Therefore on these equipment one-rope suspension is acceptable provided</p> <ol style="list-style-type: none"> 1. steel wire ropes with at least 10mm diameter are used in order to have a certain resistance against mechanical damage, 2. the factor of utilisation is at least 10, 3. the design of the rope drive is in accordance with prEN 280:1998, Annex C, with the load collective "heavy", 4. there are protective means preventing derailing of the rope from the drum or any pulley, 5. the winding up on the drum is governed by a spooling device, 6. there is a slack-rope device 7. the rope is suitably protected against corrosion and other environmental influences and 8. the instructions for use are clearly stating <ul style="list-style-type: none"> • the need of periodical inspections of the device • the need of inspection of the rope before starting work where the winch was not used for a longer period of time taking into account the provisions laid down in the EU-Directive 2009/104/EC and environmental conditions and • criteria for the replacement of the rope. <p>These provisions do not cover all aspects of these kind of LPD. Other aspects have to be subject of a risk assessment in accordance with the Machinery Directive.</p> <p>Adaptation procedure: FORMAL ADAPTATION IN CONFORMITY WITH DIRECTIVE 2006/42/EC</p>		

(1) Essential safety requirement

Note: According to point 6.6 of the Guide of the implementation of directives based on the New Approach and the Global Approach, the notified bodies apply as general guidance this recommendation for use.

	CO-ORDINATION OF NOTIFIED BODIES Machinery Directive 2006/42/EC + Amendment RECOMMENDATION FOR USE	CNB/M/09.401 Revision 08 Language: E
Date of first stage: 02/04/2003	To be approved by:	
Origin: VG9 Lifting persons device (LPD)	<input checked="" type="checkbox"/> Vertical Group <input checked="" type="checkbox"/> Horizontal Committee	Approved on: 13/04/2010 11/12/2003
		To be endorsed by: <input checked="" type="checkbox"/> Machinery Working Group....
Question related to: Directive 2006/42/EC	Article:	EN/prEN:EN 280:2001+A2:2008 Other:
Annex: I	ESR (1): 1.2.4	Other clause:
		Clause: 5.7.5 Other clause:
Key words: MEWP, control devices, emergency stop, override		
Question: Is it allowed that a MEWP is equipped with a control at the base or ground level, which functions as an override for the emergency stop control situated on the work platform for the reason of rescuing of injured or incapacitated operators?		
Solution:		
<p>CEN/TC 98/WG 1 has studied the situation in its meeting 05.96. It was felt, that the trapping of a person in the work platform can happen due to different reasons, e.g. plucking out the energy supply, actuating the emergency control device, etc. The result in these cases is an unpleasant or awkward situation but not a direct risk to the persons. Therefore a need to override the emergency stop device at the control panel cannot be seen. The standard EN 280:2001+A2:2008 states in its foreword that it is assumed that persons on the work platform in case of power supply failure are not incapacitated and can assist in the operation of the overriding emergency device.</p>		
<p>Nevertheless there may be situations where the operator is incapacitated and the platform emergency stop pressed. In this situation the overriding emergency device may be too slow to recover the operator from the ground especially for high MEWPs. Therefore the need of an overriding cannot be ignored. Any overriding of the emergency stop control at the work platform of a MEWP shall require a deliberate action on a device being a safety device, independent from the selection control device and protected against unauthorised use.</p>		
<p>Emergency stop overriding shall not be possible on MEWPs which are equipped with a mode selection device acc. to Machinery Directive 2006/42/EC Annex I section 1.2.5 to bypass safety functions.</p>		
Adaptation procedure: FORMAL ADAPTATION IN CONFORMITY WITH DIRECTIVE 2006/42/EC		

(1) Essential safety requirement

Note: According to point 6.6 of the Guide of the implementation of directives based on the New Approach and the Global Approach, the notified bodies apply as general guidance this recommendation for use.

	CO-ORDINATION OF NOTIFIED BODIES Machinery Directive 2006/42/EC + Amendment RECOMMENDATION FOR USE	CNB/M/09.501 Revision 05 Language: E
Date of first stage: 28/04/1999	To be approved by:	Approved on:
Origin: VG9 Lifting persons device (LPD)	<input checked="" type="checkbox"/> Vertical Group <input checked="" type="checkbox"/> Horizontal Committee	13/04/2010 24/05/2000
	To be endorsed by: <input checked="" type="checkbox"/> Machinery Working Group....	Endorsed on: 09/04/2001
Question related to: Directive 2006/42/EC Article: Annex: I ESR (1): 1.5.10, 1.5.11	EN/prEN: Clause: CEN TC concerned:	Other: Other clause:
Key words: Radiation, EC-type examination, EMC directive		
Question: Does EMC directive cover all aspects of radiation addressed in 1.5.10 and 1.5.11 of Annex I Machinery directive?		
<p>Solution:</p> <p>The provisions of the EMC-Directive do not cover all aspects of radiation addressed in 1.5.10 and 1.5.11.</p> <p>Especially regarding immunity of controls of LPD the following aspects need to be taken into consideration during type-examination:</p> <ol style="list-style-type: none"> 1. Light barriers shall not be influenced by light from the environment (sun, artificial light), 2. UV-radiation has influence on components made of plastic, 3. Laser beams can be dangerous for persons in the environment of the machine, 4. Sensors used as warning devices related to distances may be made inoperable, 5. Radio controls used in the environment may cause uncontrolled movements, 6. Ionised radiation may occur in case of fire, 7. Intended radiation like from mobile phones may cause malfunctions. <p>see also data sheet CNB/M/00.502</p> <p>Adaptation procedure: FORMAL ADAPTATION IN CONFORMITY WITH DIRECTIVE 2006/42/EC</p>		

(1) Essential safety requirement

Note: According to point 6.6 of the Guide of the implementation of directives based on the New Approach and the Global Approach, the notified bodies apply as general guidance this recommendation for use.

	CO-ORDINATION OF NOTIFIED BODIES Machinery Directive 2006/42/EC + Amendment RECOMMENDATION FOR USE	CNB/M/11.017 Revision 05 Language: E
Date of first stage: 10/04/1997	To be approved by:	Approved on:
Origin: VG11 Safety components	<input checked="" type="checkbox"/> Vertical Group	25/10/2010
	<input checked="" type="checkbox"/> Horizontal Committee	11/06/1998
Question related to: Directive 2006/42/EC Article: Annex: IX ESR (1):	To be endorsed by:	Endorsed on:
	<input checked="" type="checkbox"/> Machinery Working Group....	09/04/2001
EN/prEN:	Other:	
	Clause:	Other clause:
Key words: EC type-examination, pre-standards	GEN TC concerned:	
	Question: Should in case of EC type-examination European pre-standards (prEN) be used rather than national standards?	
Solution:		
Yes, the European pre-standards should be used if they represent much more the state of the art.		
It stands to reason that the procedure is accepted by the manufacturer.		
Adaptation procedure: FORMAL ADAPTATION IN CONFORMITY WITH DIRECTIVE 2006/42/EC		

(1) Essential safety requirement

Note: According to point 6.6 of the Guide of the implementation of directives based on the New Approach and the Global Approach, the notified bodies apply as general guidance this recommendation for use.

	<p style="text-align: center;">CO-ORDINATION OF NOTIFIED BODIES Machinery Directive 2006/42/EC + Amendment</p> <p style="text-align: center;">RECOMMENDATION FOR USE</p>	<p>CNB/M/11.027 Revision 08</p> <p>Language: E</p>
<p>Date of first stage: 10/04/1997</p>	<p style="text-align: center;">To be approved by:</p>	
<p>Origin: VG11 Safety components</p>	<p><input checked="" type="checkbox"/> Vertical Group</p> <p><input checked="" type="checkbox"/> Horizontal Committee</p> <p style="text-align: center;">To be endorsed by:</p> <p><input checked="" type="checkbox"/> Machinery Working Group....</p>	<p style="text-align: center;">Approved on:</p> <p style="text-align: right;">25/10/2010</p> <p style="text-align: right;">14/12/2010</p> <p style="text-align: center;">Endorsed on:</p> <p style="text-align: right;">23/05/2011</p>
<p>Question related to: Directive 2006/42/EC Article: Annex: IV-21 ESR (1):</p>	<p>EN/prEN: EN 574:1996</p> <p>Clause: 5.7.1.</p> <p>GEN TC concerned: TC 114</p>	<p style="text-align: center;">Other:</p> <p style="text-align: center;">Other clause:</p>
<p>Key words: two-hand control devices, synchronous actuation</p>		
<p>Question:</p> <p>For type III two-hand control devices, EN 574 requires synchronous actuation of both buttons in order to prevent defeating. This means that both buttons have to be actuated within a defined time range not larger than 0.5 sec.</p> <p>EN 574 allows time ranges smaller than 0.5 sec, but if the time range is too short, the operator has to concentrate highly on the synchronous actuation of the two buttons. From ergonomic aspects, this is bad. What is the minimum value of the time range?</p>		
<p>Solution:</p> <p>The requirement given in the Machinery Directive, Annex I, 1.1.6. "Under the intended conditions of use, the discomfort, fatigue and physical and psychological stress faced by the operator must be reduced to the minimum possible, taking into account ergonomic principles..." has to be observed.</p> <p>The Technical Committee responsible for EN 574 will be asked to specify a minimum value for the time range. In the meantime, for ergonomic reasons, a minimum value of 0.25 sec should be used.</p>		

(1) Essential safety requirement

Note: According to point 6.6 of the Guide of the implementation of directives based on the New Approach and the Global Approach, the notified bodies apply as general guidance this recommendation for use.

	CO-ORDINATION OF NOTIFIED BODIES Machinery Directive 2006/42/EC + Amendment RECOMMENDATION FOR USE	CNB/M/11.031 Revision 09 Language: E
Date of first stage: 01/11/2001	To be approved by:	Approved on:
Origin: VG11 Safety components	<input checked="" type="checkbox"/> Vertical Group <input checked="" type="checkbox"/> Horizontal Committee To be endorsed by: <input checked="" type="checkbox"/> Machinery Working Group....	25/10/2010 14/12/2010 Endorsed on: 23/05/2011
Question related to: Directive 2006/42/EC Article: Annex: IV-19 ESR (1):	EN/prEN: EN 61496-1/A2/Ed. 2/ CDV:2010 Clause: 4.2.2.3. CENELEC TC concerned: TC 44X	Other: Other clause:
Key words: ESPE Type 2 with PLC as means of periodic test		
<p>Question:</p> <p>A Type 2 ESPE (Electro-Sensitive Protective Equipment) consists of an assembly of a sensing device, a controlling/monitoring device and one or more Output Signal Switching Device(s) (OSSDs), which shall perform a test to reveal a failure to danger at power-on of the ESPE before going to the ON-state and at each reset as a minimum.</p> <p>This assembly can be implemented in one device, they can also be separated in two devices. In the latter case the testing and monitoring functionality can be performed in a non-safety-related PLC by software while the ESPE safety function is processed independently of the non-safety-related PLC.</p> <p>For the sensing device in combination with the controlling/monitoring device and the OSSD(s) an EC type-examination certificate can be issued.</p> <p>Is it permissible to issue an EC type-examination certificate for a sensing device intended to be combined with any customary non-safety-related PLC as a safety component according to Annex IV, 19 (Type 2 ESPE)?</p>		
<p>Solution:</p> <p>Yes, the periodic tests of the safety function during operation may be implemented in a non-safety-related PLC, if the following requirements are met:</p> <ul style="list-style-type: none"> • the testing is dynamic i.e. both high and low states are checked during the testing; • the software is as a known module protected from manipulation by the end user; • the standard PLC meets the environmental requirements of EN 61496-1 for a Type 2 ESPE; and • the instructions describe in detail: <ul style="list-style-type: none"> - the different elements which constitute the ESPE; - how the sensing device has to be connected with the PLC; and - how the fixed software module has to be implemented in the user program <p>An EC type-examination shall be carried out on this safety component consisting of the sensing device with an OSSD(s), the fixed software module, and a designated PLC with a Secondary Switching Device (SSD).</p> <p>The owner of the certificate is considered as the manufacturer of the ESPE.</p> <p>Depending on the application, the periodic test may need to be performed more often than described in the first part of the question above to achieve a desired safety performance.</p>		

(1) Essential safety requirement

Note: According to point 6.6 of the Guide of the implementation of directives based on the New Approach and the Global Approach, the notified bodies apply as general guidance this recommendation for use.

 <p style="text-align: center;">CO-ORDINATION OF NOTIFIED BODIES Machinery Directive 2006/42/EC + Amendment RECOMMENDATION FOR USE</p>	<p>CO-ORDINATION OF NOTIFIED BODIES Machinery Directive 2006/42/EC + Amendment RECOMMENDATION FOR USE</p>	<p>CNB/M/11.032 Revision 05 Language: E</p>
<p>Date of first stage: 24/09/2002</p> <p>Origin: VG11 Safety components</p>	<p>To be approved by:</p> <p><input checked="" type="checkbox"/> Vertical Group <input checked="" type="checkbox"/> Horizontal Committee</p> <p>To be endorsed by:</p> <p><input checked="" type="checkbox"/> Machinery Working Group....</p>	<p>Approved on:</p> <p>25/10/2010 03/03/2004</p> <p>Endorsed on: 24/12/2004</p>
<p>Question related to: Directive 2006/42/EC Article: Annex: IV-19 ESR (1):</p>	<p>EN/prEN: EN 61496-1:2004 + A1:2008 Clause: 4.2.5, A 5.4, A 6.4, A 7.4 GENELEC TC concerned: TC 44X</p>	<p>Other: Other clause:</p>
<p>Key words: Arrangement of visual indicators</p>		
<p>Question: EN 61496-1:2004+A1:2008 demands that ESPE (a) have visual indicators for the OSSD (b) status (red/green) and for the start/restart interlock status (yellow). There is no specification about the location where these visual indicators are to be arranged Where shall these visual indicators be arranged? Abbreviations: (a) ESPE: Electro-sensitive protective Equipment (b) OSSD: Output Switching Signal Device</p>		
<p>Solution: All visual indicators shall provide sufficient information for the machine operator. For this reason the visual indicators for start / restart condition, mute status and blanking shall be arranged in such a way that they are readily visible from any position of the operator during normal operation of the machine for which the ESPE (a) is intended as a safeguard. Indicators for the actuation of the sensing device and output status of the OSSDs (b) are intended for installation and maintenance and for that reason do not need to be visible from all positions by the operator. (a) ESPE: Electro-sensitive protective Equipment (b) OSSDs: Output Switching Signal Devices</p> <p>Adaptation procedure: FORMAL ADAPTATION IN CONFORMITY WITH DIRECTIVE 2006/42/EC</p>		

(1) Essential safety requirement

Note: According to point 6.6 of the Guide of the implementation of directives based on the New Approach and the Global Approach, the notified bodies apply as general guidance this recommendation for use.

 EUROPEAN CO-ORDINATION MACHINERY OF NOTIFIED BODIES	CO-ORDINATION OF NOTIFIED BODIES Machinery Directive 2006/42/EC + Amendment RECOMMENDATION FOR USE		CNB/M/11.033 Revision 06 Language: E
Date of first stage: 23/09/2003	To be approved by:		Approved on:
Origin: VG11 Safety components	<input checked="" type="checkbox"/> Vertical Group <input checked="" type="checkbox"/> Horizontal Committee		25/10/2010 09/12/2004
		To be endorsed by:	Endorsed on:
		<input checked="" type="checkbox"/> Machinery Working Group.... EN/prEN: RN 574:1996 Clause: 6.4.3. CEN TC concerned: TC 114	24/05/2005 Other: Other clause:
Question related to: Directive 2006/42/EC Article: Annex: IV-21 ESR (1):			
Key words: Two-hand control device, termination of one or both input signal(s) in case of a fault occurring			
Question: Does a two-hand control fulfil the requirements of EN 574:1996, clause 6.4.3 if, in case of a fault occurring, the output signal is ceased only by termination of both input signals?			
Solution: No! If a fault occurs in a type III C two-hand control device (e.g. in the right-hand push-button), then the output signal shall cease both when any input signal is terminated (e.g. by releasing the right hand) and when both of the input signals are terminated.			
Note: It is state of the art for this application that mechanical faults of push buttons are excluded when the push-buttons are in accordance with EN 60947-5-1:2009.			

**Adaptation procedure: FORMAL ADAPTATION IN CONFORMITY WITH
DIRECTIVE 2006/42/EC**

(1) Essential safety requirement

Note: According to point 6.6 of the Guide of the implementation of directives based on the New Approach and the Global Approach, the notified bodies apply as general guidance this recommendation for use.

	CO-ORDINATION OF NOTIFIED BODIES Machinery Directive 2006/42/EC + Amendment RECOMMENDATION FOR USE	CNB/M/11.035 Revision 08 Language: E
Date of first stage: 24/09/2002	To be approved by:	Approved on:
Origin: VG11 Safety components	<input checked="" type="checkbox"/> Vertical Group <input checked="" type="checkbox"/> Horizontal Committee To be endorsed by: <input checked="" type="checkbox"/> Machinery Working Group....	25/10/2010 14/12/2010 Endorsed on: 23/05/2011
Question related to: Directive 2006/42/EC Article: Annex: IV-19 ESR (1):	EN/prEN: EN 61496:2004 + A1:2008 Clause: A.7 CEN TC concerned:	Other: Other clause:
Key words: Indication of a muted ESPE, colour of the mute indicator(s) of an ESPE		
<p>Question:</p> <p>EN 61496-1, Annex A.7 (Muting) requires an indication of the muted state of an ESPE (Electro-Sensitive Protective Equipment), but does not specify a colour. What colour should be used?</p> <p>Note 1: In the old prEN 50100-1 (clause 4.2.4) the colour of the indication of the muted condition of the ESPE was required to be white. Table 2 of EN 61310-1 requires yellow for warnings, but yellow could conflict with the indication of the start or restart interlock. According to ANSI B11.19 an amber light is recommended to be used to indicate that the safeguard is muted or bypassed.</p>		
<p>Solution:</p> <p>Both colours yellow or white may be used if there is no conflict with other indicators e. g. interlock.</p> <p>Note 2: EN 61496-1:2004+A1:2008, 4.2.5 requires:</p> <p>When there are two or more indicators of the same colour the function of each indicator shall be unambiguously marked.</p>		

(1) Essential safety requirement

Note: According to point 6.6 of the Guide of the implementation of directives based on the New Approach and the Global Approach, the notified bodies apply as general guidance this recommendation for use.

	CO-ORDINATION OF NOTIFIED BODIES Machinery Directive 2006/42/EC + Amendment RECOMMENDATION FOR USE	CNB/M/11.036 Revision 07 Language: E
Date of first stage: 28/09/2004 Origin: VG11 Saftey components	To be approved by: <input checked="" type="checkbox"/> Vertical Group <input checked="" type="checkbox"/> Horizontal Committee To be endorsed by: <input checked="" type="checkbox"/> Machinery Working Group....	Approved on: 25/10/2010 14/12/2010 Endorsed on: 23/05/2011
Question related to: Directive 2006/42/EC Article: Annex: IV-19 ESR (1):	EN/prEN: Clause: CEN TC concerned:	Other: Other clause:
Key words: laser scanner, industrial truck		
Question: In narrow alleys of stocks persons may be injured by an industrial truck in case of collision between the industrial truck and a person. To prevent such accidents, laser scanners are used to detect persons and initiate a stop of the industrial truck. What are the conditions for laser scanners to be used in this application?		
Solution: Laser scanners (AOPDDRs) intended to be used for such applications shall fulfil the requirements of EN 61496-1 and CLC/TS 61496-3. As a minimum the additions and modifications listed below are to be observed. It is necessary to distinguish between those applications where: <ul style="list-style-type: none"> • access of persons is generally allowed; and • access of persons is forbidden at the time the industrial truck is operated. Therefore the following list contains general requirements and specific requirements for the two different applications (see annex).		

(1) Essential safety requirement

Note: According to point 6.6 of the Guide of the implementation of directives based on the New Approach and the Global Approach, the notified bodies apply as general guidance this recommendation for use.

1. General requirements

1.1 Detection zone dimensions

- The length of the detection zone shall be calculated taking into account the maximum speed of the industrial truck, the response times of the protective equipment, the machine control etc. and the maximum braking distance. An addition of 10 % as a minimum should be made to consider a decrease of the brakes.
- The width of the detection zone shall be such to enable the detection of the test piece defined in 1.2. It has to be taken into account that the tracking of an industrial truck always will have tolerances. For example, a tracking tolerance of 15 mm can lead to a change of the detection zones outer corner position in operation of some 10 mm. Without any user advice this can lead to problems concerning safety in terms of a decreased or not existing detection capability and on the other hand to an unacceptable low reliability in operation.

1.2 Test piece dimension

The test piece used for analysis and test shall be cylindrical with dimensions as indicated in figure 1. In most cases the detection capability will be affected by a test piece with minimum diffuse reflectivity.

Note: CLS/TS 61496-3 defines a minimum diffuse reflectivity of 1.8 % in the range of wavelength that is within the scope.

1.3 Detection capability

The detection of the test piece within the detection zone shall be guaranteed by test according to CLS/TS 61496-3. At the left and right outer border line of the detection zone the test piece shall be detected when placed with its centre in a distances of 125 mm from an empty rack. The maximum tracking tolerance as defined by the manufacturer of the protective device shall be taken into account.

1.4 Start interlock and restart interlock

Start interlock and restart interlock are required in operation when it is not guaranteed that a person is detected at any position in front of an industrial truck.

1.5 Accompanying documents

The accompanying documents shall inform the user on how to calculate the dimensions of the detection zone by example. The width of the detection zone is required to be given as a distance from the empty rack. The maximum tracking tolerance of the industrial truck together with other limiting information shall be given.

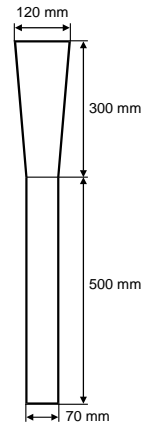

Figure 1: Test piece dimensions

2. Application where access is allowed

2.1 Type

Laser scanners intended to be used for this application shall fulfil the requirements for type 3 as defined in CLS/TS 61496-3.

2.2 Mounting

The mounting height of a laser scanner shall be as such as to enable the detection of the test piece defined in 1.2 and in addition of a person lying on the floor. To simulate this within a test, a second test piece with a diameter of 200 mm and a length of 1.000 mm shall be used.

3. Application where access is forbidden

3.1 Type

Laser scanners intended to be used for this application shall fulfil the requirements for type 3 as defined in CLS/TS 61496-3. Alternatively the fault detection requirements fulfilled by a type 2 device according to EN 61496-1 are sufficient due to the lower risk compared to the application where access is allowed.

3.2 Mounting

The mounting height of a laser scanner shall be such as to enable the detection of the test piece defined in 1.2.

3.3 Extra regulation

If the requirement to detect the test piece at the left and right outer border line of the detection zone given in 1.3 cannot be fulfilled taking into account the tracking tolerance of the industrial truck, the following extra regulation for application where access is forbidden can be applied.

- At the left and right outer border line of the detection zone the test piece shall be detected when placed with its centre in a distance of 125 mm from an empty rack. The tracking tolerance is not taken into account.
- The test piece position is varied from its original position (centre 125 mm from empty rack). For every 10 mm additional distance the length of the detection zone shall be increased by 200 mm.
- The maximum distance between the test piece centre and the empty rack is limited to 200 mm which leads to an increase of the detection zone of 1.500 mm.

	CO-ORDINATION OF NOTIFIED BODIES Machinery Directive 2006/42/EC + Amendment RECOMMENDATION FOR USE	CNB/M/11.042 Revision 04 Language: E
Date of first stage: 27/09/2005	To be approved by:	Approved on:
Origin: VG11 Safety components	<input checked="" type="checkbox"/> Vertical Group	25/10/2010
	<input checked="" type="checkbox"/> Horizontal Committee	21/11/2005
Question related to: Directive 2006/42/EC Article: Annex: IV-19 ESR (1):	To be endorsed by:	Endorsed on:
	<input checked="" type="checkbox"/> Machinery Working Group....	20/04/2006
	EN/prEN: EN 574-1:1996	Other:
Key words: Two-hand control device, non-mechanical actuating devices	Clause:	Other clause:
Question: Does EN 574: 1996 allow the use of non-mechanical actuating devices? If yes what are the requirements?	CEN TC concerned:	
	Solution: Yes. According to EN 574: 1996 clause 8.7 non-mechanical actuating devices are allowed. EN 574: 1996 has to be fulfilled. Especially clause 8.7 requires that accidental actuation has to be prevented for non-mechanically actuated devices by setting sensitivity levels which will only allow deliberate actuation.	
Adaptation procedure: FORMAL ADAPTATION IN CONFORMITY WITH DIRECTIVE 2006/42/EC		

(1) Essential safety requirement

Note: According to point 6.6 of the Guide of the implementation of directives based on the New Approach and the Global Approach, the notified bodies apply as general guidance this recommendation for use.

	CO-ORDINATION OF NOTIFIED BODIES Machinery Directive 2006/42/EC + Amendment RECOMMENDATION FOR USE	CNB/M/11.045 Revision 13 Language: E
Date of first stage: 25/10/2010 Origin: VG11 Safety components	To be approved by: <input checked="" type="checkbox"/> Vertical Group <input checked="" type="checkbox"/> Horizontal Committee To be endorsed by: <input checked="" type="checkbox"/> Machinery Working Group....	Approved on: 17/10/2011 24/06/2015 Endorsed on: 23/09/2016
Question related to: Directive 2006/42/EC Article: Annex: IV-21 ESR (1):	EN/prEN: Clause: CEN TC concerned:	Other: Other clause:
Key words: Logic units to ensure safety functions		
Question: What are logic units to ensure safety functions according to Annex IV, 21?		
Solution: Logic units to ensure safety functions are subsystems which perform safety functions by the interconnection of elements. They process input signals and generate, by a given algorithm, corresponding output signals. The logic can be e. g. - hard wired; - programmable; and/or - configurable. A list of logic units examples to ensure safety functions according to Annex IV, 21 is given as an annex to this RFU. A second list is given for examples of devices considered not to be a logic unit to ensure safety functions. A third list is given for examples of devices considered not to be a logic unit to ensure safety functions according to Annex IV, 21 because they are listed in Annex IV, 19 See also <i>Guide to application of the Machinery Directive 2006/42/EC 2nd Edition</i> – June 2010, Page 347, Item 21.		

(1) Essential safety requirement

Note: According to point 6.6 of the Guide of the implementation of directives based on the New Approach and the Global Approach, the notified bodies apply as general guidance this recommendation for use.

Logic units to ensure safety functions according to Annex IV, 21 include e.g.:

- Proximity devices for safety functions (for example PDF-X according to EN 60947-5-3);
- Interlocking devices with electromagnetic guard locking (e.g. locking by magnetic force as opposed to locking with a bolt) for safety functions according to EN ISO 14119 (for protection of persons);
- Trapped-key interlocking systems for safety functions, where the algorithm is included in the system;
- Protective devices for indirect detection of the presence of persons, for example by the use of RFID technology;
- Protective devices for the detection and deactivation of possible hazards (not a warning system only), such as the detection of laser radiation;
- Safety control units, for example for the monitoring of speed, vibration, torque, temperature, pressure, force, guards, emergency stop devices, two-hand control devices, enabling device
- Rotary encoders, length measuring devices, speed measuring devices and braking control units with integrated logic intended to be used in safety functions;
- Safety PLCs;
- Remote controls contributing to at least one safety function, e.g. emergency stop;
- Power Drive Systems (for example PDS(SR) according to EN 61800-5-2) with one or more integrated safety functions (e.g. STO, SS1, SS2, SLS, SBC), e. g. frequency inverters, servo converters;
- Time delay devices for safety functions;
- Devices for the logical processing of safety-related signals of safety bus systems; excluding devices/components to be applied in "black channels" according to EN 61784-3 (black channel: communication channel without available evidence of design or validation according to IEC 61508);
- Banks of valves with self-contained logic combination of safety relevant signals, for example a safety valve block for presses;

All devices are intended to be applied in performing a safety function(s). The manufacturer must give at least one of the following product characteristics: Performance Level (PL) or Safety Integrity Level (SIL).

The following devices are considered not to be a logic unit to ensure safety functions according to Annex IV, 21 because they do not perform logic operations for the control of a safety function(s):

- Position switches with direct opening action according to EN 60947-5-1, Annex K;
- Interlocking devices with mechanical guard locking according to EN 1088 (for protection of persons);
- Emergency stop devices;
- Enabling switches (e.g. three-position enabling switches);
- Relays/contactor relays with mechanically linked contacts;
- Contactors with mirror contacts;
- Contact expansion modules; enhancement to safety switchgear;
- Devices for under-voltage release for supply disconnecting devices (main switches), intended for use in safety functions (for example to prevent restarting following power restoration);
- Brake assemblies;
- Valves with additional means for failure detection intended for the control of dangerous movements on machinery;
- Equipment for protection against overpressure, e.g. pressure valves;
- Equipment for stopping of movement (e. g. resettable check valves);
- Safety clamps for piston rods of hydraulic or pneumatic cylinders.

The following devices are considered not to be a logic unit to ensure safety functions according to Annex IV, 21 because they are listed in Annex IV, 19:

- Protective devices designed to detect the presence of persons, e.g. electro-sensitive protective equipment (light curtains, laser scanners, vision systems, ultrasonic devices) and pressure-sensitive protective devices (mats, edges, bumpers etc.)

Note concerning RFU 11.045 Rev 10 (and higher)

RFU 11.045 Rev 10 was approved by the Horizontal Committee on 18/06/2014 and endorsed by the Machinery Working Group on 08/01/2015.

In comparison with Revision 06 that has been published in August 2012, mainly editorial changes and clarifications have been made. However, there was one technical change: in the list of examples to be considered logic units to ensure safety functions in the sense of Annex IV, item 21, **“Remote controls with integrated logic intended to be used in safety functions”** were added.

As of Rev 11 this entry was modified to read **“Remote controls contributing to at least one safety function, e.g. emergency stop”** in order to clarify the wording.

Consequently, manufacturers that have up to now not been aware that “Remote controls contributing to at least one safety function, e.g. emergency stop” are in the scope of Annex IV, item 21, will have to submit their products to a CE-type-examination, at least as long as there is no harmonized standard giving presumption of conformity in this matter (standard IEC 62745 is currently under development). Therefore, a transition period should be defined to give manufacturers the time needed to have their products type-examined.

	CO-ORDINATION OF NOTIFIED BODIES Machinery Directive 2006/42/EC + Amendment RECOMMENDATION FOR USE		CNB/M/11.047 Revision 03 Language: E
Date of first stage: 11/05/2010	To be approved by:		Approved on:
Origin: VG11 Safety components	<input checked="" type="checkbox"/> Vertical Group <input checked="" type="checkbox"/> Horizontal Committee		11/05/2010 15/06/2010
Question related to: Directive 2006/42/EC Article: Annex: I ESR (1): 1.2.1	EN/prEN: EN ISO 13849-1 / EN 62061 Clause: CEN TC concerned:		Other: Other clause:
Key words: Using parts with wear-out in safety components			
<p>Question:</p> <p>How do parts with wear-out such as relays have to be taken into account when estimating the PFH_d (a) of a safety component?</p> <p>Abbreviation:</p> <p>(a) PFH_d: Probability of dangerous Failure per Hour</p>			
<p>Solution:</p> <p>The PL or SIL of a safety component depends on the PFH_d (a). It is not sufficient however to specify PFH_d (a) as the sole safety parameter without stating the conditions under which this value is valid.</p> <p>Standards such as EN ISO 13849-1 or EN 62061 use the concept of B10_d when calculating probability of failures. This concept takes into account e.g. the average number of operations per time unit and the load conditions.</p> <p>Note: Information on procedures to determine B10_d values are given e.g. in EN 60947-4-1 for contactors or in IEC 61810-2-1 for electromechanical elementary relays and ISO 19973-1, -2 for pneumatic components. Typical values for B10_d can be found in EN ISO 13849-1, Annex C.</p> <p>VG11 replaced the term "PFH" by "PFH_d" and added the note on 26/10/2010.</p>			

(1) Essential safety requirement

Note: According to point 6.6 of the Guide of the implementation of directives based on the New Approach and the Global Approach, the notified bodies apply as general guidance this recommendation for use.

	<p style="text-align: center;">CO-ORDINATION OF NOTIFIED BODIES Machinery Directive 2006/42/EC + Amendment</p> <p style="text-align: center;">RECOMMENDATION FOR USE</p>		<p>CNB/M/11.049 Revision 03</p> <p>Language: E</p>	
Date of first stage: 25/10/2010	To be approved by:		Approved on:	
Origin: VG11 Safety components	<input checked="" type="checkbox"/> Vertical Group	25/10/2010	<input checked="" type="checkbox"/> Horizontal Committee	14/12/2010
		To be endorsed by:		Endorsed on:
		<input checked="" type="checkbox"/> Machinery Working Group....		23/05/2011
Question related to: Directive 2006/42/EC Annex: IV-21	Article:	EN/prEN:	Other:	
	ESR (1):	Clause:	Other clause:	
		CEN TC concerned:		
Key words: logic units to ensure safety functions / Environmental conditions				
Question:				
Logic units to ensure safety functions shall be tested in environmental conditions (climatic, electrical, EMC, vibrations, bump, etc.). For the time being, there is no general standard for the detailed requirements.				
How can the test laboratory determine these requirements?				
Solution:				
There is no general standard for logic units and the requirements depend highly on the application, the technology used, and the expected environmental conditions. Therefore, it is the task of the Notified Body to determine the appropriate requirements.				

(1) Essential safety requirement

Note: According to point 6.6 of the Guide of the implementation of directives based on the New Approach and the Global Approach, the notified bodies apply as general guidance this recommendation for use.

	CO-ORDINATION OF NOTIFIED BODIES Machinery Directive 2006/42/EC + Amendment RECOMMENDATION FOR USE	CNB/M/11.050 Revision 05 Language: E
Date of first stage: 18/10/2011	To be approved by:	Approved on:
Origin: VG11 Safety components	<input checked="" type="checkbox"/> Vertical Group <input checked="" type="checkbox"/> Horizontal Committee To be endorsed by: <input checked="" type="checkbox"/> Machinery Working Group....	06/06/2013 26/06/2013 Endorsed on: 22/11/2013
Question related to: Directive 2006/42/EC Article: Annex: IV – 19, 20, 21 and Annex I ESR (1): 1.2.1	EN/prEN: Clause: CEN TC concerned:	Other: Other clause:
Key words: Failure, electromechanical outputs		
Question: What are the minimum requirements concerning the frequency of tests for failure detection in a safety-related system with 2 channels with electromechanical outputs (relays or contactors)?		
Solution: A functional test (automatic or manual) to detect failures shall be performed within the following test intervals: a) at least every month for PL e with Category 3 or Category 4 (according to EN ISO 13849-1) or SIL 3 with HFT (hardware fault tolerance) = 1 (according to EN 62061); b) at least every 12 months for PL d with Category 3 (according to EN ISO 13849-1) or SIL 2 with HFT (hardware fault tolerance) = 1 (according to EN 62061). NOTE: It is recommended that the functional test is initiated by the control system of the machine. If this is not possible, then it is recommended that the control system of the machine reminds the user (e.g. by an appropriate indication at the control panel) to perform a functional test of the safety function. If this is also not possible, an appropriate requirement has to be contained in the instructions for use.		

(1) Essential safety requirement

Note: According to point 6.6 of the Guide of the implementation of directives based on the New Approach and the Global Approach, the notified bodies apply as general guidance this recommendation for use.

	CO-ORDINATION OF NOTIFIED BODIES Machinery Directive 2006/42/EC + Amendment RECOMMENDATION FOR USE	CNB/M/11.052 Revision 02 Language: E
Date of first stage: 18/10/2011	To be approved by:	Approved on:
Origin: VG11 Safety components	<input checked="" type="checkbox"/> Vertical Group <input checked="" type="checkbox"/> Horizontal Committee To be endorsed by: <input checked="" type="checkbox"/> Machinery Working Group....	18.10.2011 13/12/2011 Endorsed on: 23/04/2012
Question related to: Directive 2006/42/EC Article: 2 (c) Annex: ESR (1):	EN/prEN: Clause: CEN TC concerned:	Other: Other clause:
Key words: Safety components, safety functions		
Question: Some devices (e.g. an industrial remote control) incorporate non-safety related functions and one or more safety functions. Are such devices to be considered as safety components in the sense of the Machinery Directive?		
Solution: Yes. As soon as a device serves to fulfil a safety function, it is considered as safety component in the sense of the Machinery Directive, provided that the other conditions according to Article 2 (c) of the Machinery Directive are met. The safety-related part has to fulfil the essential requirements of the Machinery Directive. During conformity assessment, the non-safety-related parts also have to be considered to ensure that they have no negative influence on the safety-related part.		

(1) Essential safety requirement

Note: According to point 6.6 of the Guide of the implementation of directives based on the New Approach and the Global Approach, the notified bodies apply as general guidance this recommendation for use.

	CO-ORDINATION OF NOTIFIED BODIES Machinery Directive 2006/42/EC + Amendment RECOMMENDATION FOR USE	CNB/M/11.053 Revision 03 Language: E
Date of first stage: 10/05/2012	To be approved by:	
Origin: VG11 Safety components	<input checked="" type="checkbox"/> Vertical Group 10/05/2012 <input checked="" type="checkbox"/> Horizontal Committee 28/06/2012	
	To be endorsed by: <input checked="" type="checkbox"/> Machinery Working Group.... 17/01/2013	
Question related to: Directive 2006/42/EC Article: Annex: I ESR (1): 1.2.1	EN/prEN: EN ISO 13849-1:2008 Clause: 5.2.2. CEN TC concerned: TC 114	Other: Other clause:
Key words: Manual reset function		
<p>Question:</p> For the manual reset function in logic units to ensure safety functions, EN ISO 13849-1, subclause 5.2.2, 6th indent, requires the change of the state of the reset button from pressed to released. In some logic units to ensure safety functions the manual reset function was designed to react to the change of the state of the reset button from released to pressed, as was required in EN 954-1, subclause 5.4. Do these logic units comply with the requirements of the Machinery directive?		
<p>Solution:</p> Yes. In this case, the technical file has to contain a statement that the product does not fully comply with the 6th indent of subclause 5.2.2 of EN ISO 13849-1. The manufacturer of the logic unit has to show that the manual reset function has an appropriate Performance Level. The same level of safety provided by the technical solution in the 6th indent of subclause 5.2.2 of EN ISO 13849-1 can be achieved by other technical solutions.		

(1) Essential safety requirement

Note: According to point 6.6 of the Guide of the implementation of directives based on the New Approach and the Global Approach, the notified bodies apply as general guidance this recommendation for use.

	CO-ORDINATION OF NOTIFIED BODIES Machinery Directive 2006/42/EC + Amendment RECOMMENDATION FOR USE		CNB/M/11.054 Revision 03 Language: E
Date of first stage: 06/06/2013	To be approved by:		Approved on:
Origin: VG11 Safety components	<input checked="" type="checkbox"/> Vertical Group		06/06/2013
	<input checked="" type="checkbox"/> Horizontal Committee		26/06/2013
Question related to: Directive 2006/42/EC Article: Annex: I ESR (1): 1.7.4.		EN/prEN:	Other:
		Clause:	Other clause:
		CEN TC concerned:	
Key words: Safety components, instructions			
Question: Which parts of the instructions for use have to be provided in paper form?			
Solution: Two levels have to be distinguished: 1) In the case of safety components where tools (PC, tablets etc. with or without internet access) are necessary for the integration of the safety component, health and safety relevant information can be supplied partly in paper form (quick-start-guide) and partly in electronic form. The quick-start-guide has to contain as a minimum the following: - identification of the safety component to which it belongs, - information on connections and interfaces, - information on the intended use, - information on the reasonably foreseeable misuse, - conditions and limitations for use, - information, where the complete instructions for use can be found. 2) In the case of safety components where such tools are not needed, health and safety relevant information has to be supplied in paper form.			

(1) Essential safety requirement

Note: According to point 6.6 of the Guide of the implementation of directives based on the New Approach and the Global Approach, the notified bodies apply as general guidance this recommendation for use.

	CO-ORDINATION OF NOTIFIED BODIES Machinery Directive 2006/42/EC + Amendment RECOMMENDATION FOR USE	CNB/M/11.055 Revision 04 Language: E
Date of first stage: 07/06/2013	To be approved by:	Approved on:
Origin: VG11 Safety components	<input checked="" type="checkbox"/> Vertical Group <input checked="" type="checkbox"/> Horizontal Committee	02/06/2014 17/06/2014
	To be endorsed by:	Endorsed on:
	<input checked="" type="checkbox"/> Machinery Working Group....	08/01/2015
Question related to: Directive 2006/42/EC	Article: 2 (c)	EN/prEN: Other:
Annex: I	ESR (1): 1.5.1.	Clause: Other clause:
	CEN TC concerned:	
Key words: Cogeneration plants, combined heat and power plants (CHP), grid monitoring		
Question:		
Is the grid monitoring device of a cogeneration plant considered a safety component in the sense of Article 2 (c) of the Machinery Directive, if it is placed on the market independently?		
Solution:		
Yes.		
<p>If a local installation with cogeneration plant is disconnected from the electrical power grid, the cogeneration plant could still feed energy into the local installation. This situation is hazardous because some persons might think there is no electrical hazard due to the disconnection from the electrical power grid. In these cases, grid monitoring devices are used to</p> <ul style="list-style-type: none"> - disconnect the cogeneration plant from the local installation, and - in some cases - shut down the generator and prevent start-up. 		
<p>Grid monitoring devices therefore serve to reduce a risk coming from cogeneration plants and are consequently considered a safety component in the sense of Article 2 (c) of the Machinery Directive and furthermore as a logic unit for safety functions in the sense of Annex IV, item 21.</p>		

(1) Essential safety requirement

Note: According to point 6.6 of the Guide of the implementation of directives based on the New Approach and the Global Approach, the notified bodies apply as general guidance this recommendation for use.

	<p>CO-ORDINATION OF NOTIFIED BODIES Machinery Directive 2006/42/EC + Amendment RECOMMENDATION FOR USE</p>	<p>CNB/M/11.056 Revision 03 Language: E</p>
<p>Date of first stage: 07/06/2013</p>	<p>To be approved by:</p>	<p>Approved on:</p>
<p>Origin: VG11 Safety components</p>	<p><input checked="" type="checkbox"/> Vertical Group</p> <p><input checked="" type="checkbox"/> Horizontal Committee</p> <p>To be endorsed by:</p> <p><input checked="" type="checkbox"/> Machinery Working Group....</p>	<p>07/06/2013 26/06/2013 Endorsed on: 22/11/2013</p>
<p>Question related to: Directive 2006/42/EC Article: Annex: I ESR (1): 1.2.1.</p>	<p>EN/prEN: EN 574:1996+A1:2008 Clause: 5.7 CEN TC concerned: TC 114</p>	<p>Other: Other clause:</p>
<p>Key words: Two-hand control devices, synchronous actuation, operating conditions</p>		
<p>Question: EN 574:1996+A1:2008 requires in its subclause 5.7 a synchronous actuation of both actuators in a period of time less than or equal to 0.5 s. Is it necessary that this maximum synchronisation time is observed also under variation of operating conditions such as the supply voltage?</p>		
<p>Solution: Yes. The maximum synchronisation time is a safety feature and shall therefore not be exceeded under the operating conditions stated by the manufacturer. NOTE: Generally, all safety functions have to work correctly under the operating conditions stated by the manufacturer and by standards.</p>		

(1) Essential safety requirement

Note: According to point 6.6 of the Guide of the implementation of directives based on the New Approach and the Global Approach, the notified bodies apply as general guidance this recommendation for use.

	CO-ORDINATION OF NOTIFIED BODIES Machinery Directive 2006/42/EC + Amendment RECOMMENDATION FOR USE	CNB/M/11.058 Revision 03 Language: E
Date of first stage: 07/06/2013	To be approved by:	Approved on:
Origin: VG11 Safety components	<input checked="" type="checkbox"/> Vertical Group <input checked="" type="checkbox"/> Horizontal Committee To be endorsed by: <input checked="" type="checkbox"/> Machinery Working Group....	07/06/2013 26/06/2013 Endorsed on: 22/11/2013
Question related to: Directive 2006/42/EC Article: 2(c) Annex: ESR (1):	EN/prEN: Clause: CEN TC concerned:	Other: Other clause:
Key words: Safety component, warning device		
Question: Is a warning device that requires the action of the operator to achieve a safe state considered a safety component in the sense of Article 2 (c) of the Machinery Directive?		
Solution: No. However, the device can be assessed according to functional safety standards used for safety components.		

(1) Essential safety requirement

Note: According to point 6.6 of the Guide of the implementation of directives based on the New Approach and the Global Approach, the notified bodies apply as general guidance this recommendation for use.

	CO-ORDINATION OF NOTIFIED BODIES Machinery Directive 2006/42/EC + Amendment RECOMMENDATION FOR USE	CNB/M/11.059 Revision 03 Language: E								
Date of first stage: 03/06/2014	To be approved by:	Approved on:								
Origin: VG11 Safety components	<input checked="" type="checkbox"/> Vertical Group <input checked="" type="checkbox"/> Horizontal Committee To be endorsed by: <input checked="" type="checkbox"/> Machinery Working Group....	03/06/2014 17/06/2014 Endorsed on: 08/01/2015								
Question related to: Directive 2006/42/EC Article: Annex: IV - 19 / 20 / 21 ESR (1):	EN/prEN: EN 61508 Clause: CEN TC concerned: CLC/TC 65X	Other: Other clause:								
Key words: Diagnostic functions, EN 61508:2010										
Question: How shall failures in diagnostic functions in single-channel structures (HFT = 0) be analysed and evaluated if EN 61508:2010 is used?										
Solution: <p>Failures in diagnostic functions that can directly introduce a failure in the safety function / element safety function should be handled like failures in the safety function / element safety function itself.</p> <p>For diagnostic functions that cause a critical state related to the safety function / element safety function in a two or more fault scenario one of the following approaches shall be applied:</p> <ol style="list-style-type: none"> The diagnostic functions are considered as separate functions and shall fulfill the requirements as shown in the table below. <table border="1" data-bbox="247 1388 778 1556"> <thead> <tr> <th>Safety function</th> <th>Diagnostic function</th> </tr> </thead> <tbody> <tr> <td>SIL 1</td> <td>Basic safety principles</td> </tr> <tr> <td>SIL 2</td> <td>SIL 1</td> </tr> <tr> <td>SIL 3</td> <td>SIL 2</td> </tr> </tbody> </table> A failure in a diagnostic function that increases the probability that the safety function does not operate correctly when required, shall be classified as dangerous failure according to IEC 61508-4:2010, clause 3.6.7. A failure in a diagnostic function that leads directly to the safe state shall be classified as safe failure according to IEC 61508-4:2010, clause 3.6.8. <p>Note: For diagnostic functions monitoring only other diagnostics functions, no safety requirements have to be applied.</p>			Safety function	Diagnostic function	SIL 1	Basic safety principles	SIL 2	SIL 1	SIL 3	SIL 2
Safety function	Diagnostic function									
SIL 1	Basic safety principles									
SIL 2	SIL 1									
SIL 3	SIL 2									

(1) Essential safety requirement

Note: According to point 6.6 of the Guide of the implementation of directives based on the New Approach and the Global Approach, the notified bodies apply as general guidance this recommendation for use.

	CO-ORDINATION OF NOTIFIED BODIES Machinery Directive 2006/42/EC + Amendment RECOMMENDATION FOR USE	CNB/M/11.060 Revision 03 Language: E
Date of first stage: 03/06/2014	To be approved by:	Approved on:
Origin: VG11 Safety components	<input checked="" type="checkbox"/> Vertical Group <input checked="" type="checkbox"/> Horizontal Committee	03/06/2014 18/06/2014
	To be endorsed by:	Endorsed on:
	<input checked="" type="checkbox"/> Machinery Working Group....	08/01/2015
Question related to: Directive 2006/42/EC	Article:	EN/prEN: EN 60204-1
Annex: IV - 19 / 20 / 21	ESR (1): 1.2.1.	Other:
	Clause:	Other clause:
	CEN TC concerned:	
Key words: External DC power supply of safety component, PELV, abnormal voltage		
Question:		
What abnormal supply voltage of an external DC power supply has to be considered for a safety component intended to be supplied with PELV (protective extra low voltage) according to EN 60204-1?		
Solution:		
For supply voltages up to 60 V DC, the safety component has to remain in a safe state.		
NOTE: EN 60204-1:2006, 6.4.2, requires that PELV does not exceed 60 V DC, even in case of a failure.		

(1) Essential safety requirement

Note: According to point 6.6 of the Guide of the implementation of directives based on the New Approach and the Global Approach, the notified bodies apply as general guidance this recommendation for use.

	CO-ORDINATION OF NOTIFIED BODIES Machinery Directive 2006/42/EC + Amendment RECOMMENDATION FOR USE	CNB/M/11.062 Revision 04 Language: E
Date of first stage: 09/06/2015	To be approved by:	Approved on:
Origin: VG11 Safety components	<input checked="" type="checkbox"/> Vertical Group <input checked="" type="checkbox"/> Horizontal Committee To be endorsed by: <input checked="" type="checkbox"/> Machinery Working Group....	09/06/2015 02/12/2015 Endorsed on: 23/09/2016
Question related to: Directive 2006/42/EC Article: 2 c) Annex: IV - 19 ESR (1):	EN/prEN: EN ISO 13856 series Clause: GEN TC concerned:	Other: Other clause:
Key words: pressure-sensitive protective device, sensor, control unit, OSSDs, definition		
Question: What is a pressure-sensitive mat (or edge or buffer)?		
Solution: According to the definitions in the EN ISO 13856 series, a pressure-sensitive protective device consists of a sensor, a control unit and OSSDs (output signal switching devices). Therefore, a sensor alone (although commonly referred to as mat, edge or buffer) is not a safety component in the sense of the Machinery Directive. Example: According to EN ISO 13856-1, 3.1, the definition of pressure-sensitive mat reads: "Sensitive protective equipment (ISO 12100:2010, 3.28.5) comprising a sensor (3.3) or sensors, a control unit (3.5) and one or more one or more output signal switching devices (3.6) which detects a person standing on it or who steps onto it and where the effective sensing area (3.4) is deformed locally when the sensor(s) is actuated." So in the EN ISO 13856 series, the term "mat" (or "edge" or "buffer") is not used for the sensor, but for the combination of sensor, control unit and OSSDs.		

(1) Essential safety requirement

Note: According to point 6.6 of the Guide of the implementation of directives based on the New Approach and the Global Approach, the notified bodies apply as general guidance this recommendation for use.

	CO-ORDINATION OF NOTIFIED BODIES Machinery Directive 2006/42/EC + Amendment RECOMMENDATION FOR USE	CNB/M/12.009 Revision 05 Language: E
Date of first stage: 07/05/1996	To be approved by:	Approved on:
Origin: VG 12 ROPS and FOPS	<input checked="" type="checkbox"/> Vertical Group <input checked="" type="checkbox"/> Horizontal Committee	21/11/2013 10/12/2013
	To be endorsed by:	Endorsed on:
	<input checked="" type="checkbox"/> Machinery Working Group....	15/04/2014
Question related to: Directive 2006/42/EC	Article:	EN/prEN:
Annex: I	ESR (1): 3.4.3., 3.4.4.	Other:
		Other clause:
	CEN TC concerned:	
Key words: Minor modification		
Question:		
What kind of modifications of ROPS and FOPS can be accepted without new test?		
Solution:		
Safety cabs will be modified during the course of their production life. In order to make it simpler for all involved modifications to a tested safety cab may be made without requiring a retest.		
<ol style="list-style-type: none"> 1) Change of model denomination as a result of production processing, e.g. painting, trimming are not structural and therefore consideration to test mass used for a ROPS test may be the only additional information needed for model changes. 2) The drilling of holes for wiring or painting process and the addition for brackets for mounting of mirrors, lights, etc. needs consideration to given to the size an location and whether they would affect the test result. 3) Changes of seats resulting in new positions for SIP (seat index point), changes to the design or size of structural members including the addition of gussets, changes which affect the clearance between DLV (deflection-limiting volume) and safety cab or ground line changes of mounting brackets are beyond the understanding of minor modifications. This does not mean that they can not be considered. However as a notified body you must be confident that in the event of a fatal accident you can produce evidence that any modifications approved offer the same protection as the original design. It is also important to keep in mind that comparison tests between say different mounts is not the total affect on the original test, as the safety cab and mounts work as an unit. With these points in mind may we suggest that modifications of this nature are very hard to substantiate. 		
The additional data sheet of the original certificate must contain:		
<ul style="list-style-type: none"> - a reference to the original certificate - a reference to the original test report - a unique number for this modifications - a description of the changes made including references to drawings and issue numbers - declaration of acceptance - the date of approval and – if applicable – limited series numbers 		

(1) Essential safety requirement

Note: According to point 6.6 of the Guide of the implementation of directives based on the New Approach and the Global Approach, the notified bodies apply as general guidance this recommendation for use.

	CO-ORDINATION OF NOTIFIED BODIES Machinery Directive 2006/42/EC + Amendment RECOMMENDATION FOR USE		CNB/M/13.000 Revision 03 Language: EN
Date of first stage: 21/08/2008	To be approved by:		Approved on:
Origin: VG13 Full quality assurance	<input checked="" type="checkbox"/> Vertical Group..... <input checked="" type="checkbox"/> Horizontal Committee.....		21/08/2008 09/12/2008
Question related to: 2006/42/EC Article: Annex: X EHSR (1):		EN/prEN: Normative clause: CEN TC concerned:	Other: Other clause:
Key words: equivalence to Annex IX			
Question: Do Annex IX and Annex X conformity assessment procedures lead to equivalent results, namely safe and compliant machines?			
Recommended solution: Yes. The outcome of Annex IX and Annex X conformity assessment procedures should be equivalent, namely safe and compliant machines. The focus of Annex IX is the type examination of a sample of the product by the Notified Body while for Annex X the focus of the Notified Body lies on the processes of design and manufacturing of the machinery. In both cases the manufacturer has responsibilities which can only be spot-checked by the Notified Body knowing that the outcome of both modules is considered equivalent.			

(1) Essential health and safety requirement

Note: According to point 6.6 of the Guide of the implementation of directives based on the New Approach and the Global Approach, the notified bodies apply as general guidance this recommendation for use.

	CO-ORDINATION OF NOTIFIED BODIES Machinery Directive 2006/42/EC + Amendment RECOMMENDATION FOR USE	CNB/M/13.001 Revision 04 Language: E
Date of first stage: 21/01/2008	To be approved by:	Approved on:
Origin: VG13 Full quality assurance	<input checked="" type="checkbox"/> Vertical Group <input checked="" type="checkbox"/> Horizontal Committee To be endorsed by: <input checked="" type="checkbox"/> Machinery Working Group....	17/09/2007 10/06/2008 Endorsed on: 08/01/2009
Question related to: Directive 2006/42/EC Article: Annex: X clause 1 ESR (1):	EN/prEN: Clause: CEN TC concerned:	Other: Other clause:
Key words: final inspection, quality management, intermediate inspections		
Question: Does final inspection and testing only refer to tests after manufacturing?		
Solution: No. Although the wording of the directive suggests that the final inspection takes place after manufacturing, it seems clear that a quality management system for "design, manufacture, final inspection and testing" also contains appropriate intermediate inspections and tests during the production phase. These activities are under the responsibility of the manufacturer and are to be differentiated from the direct conformity assessment carried out by the Notified Bodies, however the Notified Bodies shall take account of these activities in their assessment. Note: Production phase includes design, manufacture, inspection, testing and storage for the machinery		

(1) Essential safety requirement

Note: According to point 6.6 of the Guide of the implementation of directives based on the New Approach and the Global Approach, the notified bodies apply as general guidance this recommendation for use.

	CO-ORDINATION OF NOTIFIED BODIES Machinery Directive 2006/42/EC + Amendment RECOMMENDATION FOR USE	CNB/M/13.002 Revision 07 Language: E
Date of first stage: 13/06/2009	To be approved by:	Approved on:
Origin: VG13 Full quality assurance	<input checked="" type="checkbox"/> Vertical Group	26/08/2010
	<input checked="" type="checkbox"/> Horizontal Committee	14/12/2010
Question related to: Directive 2006/42/EC Article: Annex: X clause 1 ESR (1):	To be endorsed by:	Endorsed on:
	<input checked="" type="checkbox"/> Machinery Working Group....	23/05/2011
	EN/prEN:	Other:
Annex: X clause 1	Clause:	Other clause:
Key words: quality system, compliance with standards, accreditation	CEN TC concerned:	
Question: Is it necessary for the manufacturer to have a quality system according to ISO 9001?		
Solution: No, compliance with the requirements of EN ISO 9001 normally provides a presumption of conformity to the relevant requirements of module H. However, since there are several additional requirements in the Annex X, compliance with ISO 9001 alone is certainly not sufficient as such to demonstrate compliance with the requirements of the directive. On the other hand, compliance with the standard is not mandatory, but the quality system must comply with the essential requirements of Annex X: no more, no less.		

(1) Essential safety requirement

Note: According to point 6.6 of the Guide of the implementation of directives based on the New Approach and the Global Approach, the notified bodies apply as general guidance this recommendation for use.

	CO-ORDINATION OF NOTIFIED BODIES Machinery Directive 2006/42/EC + Amendment RECOMMENDATION FOR USE	CNB/M/13.003 Revision 04 Language: E
Date of first stage: 21/01/2008	To be approved by:	Approved on:
Origin: VG13 Full quality assurance	<input checked="" type="checkbox"/> Vertical Group <input checked="" type="checkbox"/> Horizontal Committee To be endorsed by: <input checked="" type="checkbox"/> Machinery Working Group....	17/09/2007 10/06/2008 Endorsed on: 08/01/2009
Question related to: Directive 2006/42/EC Article: Annex: X clause 2.1 ESR (1):	EN/prEN: Clause: CEN TC concerned:	Other: Other clause:
Key words: application, quotation, selection of Notified Body		
Question: What is meant by application in the terms of clause 2.1 of Annex X and in particular the last bullet point?		
Solution: It is not the intention of this requirement to restrict the manufacturer from obtaining several quotations, but simply prevent the practice of going from one Notified Body (NB) to another until one will issue certification. It is permissible for the Manufacturer to approach one or more Notified Bodies (NBs) and invite them to issue a quotation for providing the necessary assessment services required by Annex X of the Machinery Directive 2006/42/EC. The NBs that have been approached may require the manufacturer to supply relevant information to enable them to prepare the required quotation. This information may be submitted verbally or in written form as required by the NB. Once the manufacturer has decided to select a single NB to provide the necessary services that manufacturer shall be required to enter into an agreement (e.g. a contract) with that NB. In that agreement the manufacturer declares that they have not entered into a contract with any other NB to provide similar services for the same category or categories of machine. The selected NB will then request (if not already provided) the remaining information specified within clause 2.1 of Annex X.		

(1) Essential safety requirement

Note: According to point 6.6 of the Guide of the implementation of directives based on the New Approach and the Global Approach, the notified bodies apply as general guidance this recommendation for use.

	CO-ORDINATION OF NOTIFIED BODIES Machinery Directive 2006/42/EC + Amendment RECOMMENDATION FOR USE	CNB/M/13.004 Revision 04 Language: E
Date of first stage: 21/01/2008	To be approved by:	Approved on:
Origin: VG13 Full quality assurance	<input checked="" type="checkbox"/> Vertical Group <input checked="" type="checkbox"/> Horizontal Committee To be endorsed by: <input checked="" type="checkbox"/> Machinery Working Group....	17/09/2007 10/06/2008 Endorsed on: 08/01/2009
Question related to: Directive 2006/42/EC Article: Annex: X clause 2.1 – 2 nd indent ESR (1):	EN/prEN: Clause: CEN TC concerned:	Other: Other clause:
Key words: manufacturer, sub-contractors, conformity, supplier, subsidiaries		
Question: Do substantial subcontract activities of the manufacturer need to be identified?		
Solution: Yes. Where the manufacturers sub-contract the whole, or a significant part, of either design, manufacturing, inspection, testing or installation (where installation is part of the deliverable) they shall declare this to the Notified Body they have selected to provide the services required. Significant in this context can mean an important activity which could have a bearing upon the final conformity of the product with the applicable legislation/standards (examples are full design of the machinery, manufacturing of an important subassembly having direct impact on safety). This does not apply to safety components (e.g. light curtains) or basic sub-assemblies procured completely from a supplier. The machinery manufacturer is responsible for obtaining from his sub-contractor the information and documentation required for the application of the Annex X. If the manufacturer is not able to provide the required documentation this shall be considered to be a major nonconformity. For important subcontracting the Notified Body shall be required to visit the sub-contractor site. This shall be made by the Notified Body or on behalf of the Notified Body. It is the responsibility of the machinery manufacturer to ensure access. The basic principle is that the same logic shall be applied to a virtual manufacturer and a real manufacturer. If relevant work has been performed by different Notified Bodies at the sub-contractor site, this should be taken into account.		

(1) Essential safety requirement

Note: According to point 6.6 of the Guide of the implementation of directives based on the New Approach and the Global Approach, the notified bodies apply as general guidance this recommendation for use.

	CO-ORDINATION OF NOTIFIED BODIES Machinery Directive 2006/42/EC + Amendment RECOMMENDATION FOR USE	CNB/M/13.005 Revision 04 Language: E
Date of first stage: 28/01/2008	To be approved by:	Approved on:
Origin: VG13 Full quality assurance	<input checked="" type="checkbox"/> Vertical Group <input checked="" type="checkbox"/> Horizontal Committee To be endorsed by: <input checked="" type="checkbox"/> Machinery Working Group....	17/09/2007 10/06/2008 Endorsed on: 08/01/2009
Question related to: Directive 2006/42/EC Article: Annex: X clause 2.1 – 3 rd indent ESR (1):	EN/prEN: Clause: CEN TC concerned:	Other: Other clause:
Key words: representative model, categories of machinery, risks		
Question: Who is choosing the model and what is the category?		
Solution: The headline of Annex IV is: “Categories of machinery to which one of the procedures referred to in Article 12(3) and (4) must be applied”. Categories are therefore defined, i.e. each group of machinery listed in one of the paragraphs from 1 to 23 or paragraphs 1.1, 1.2, 1.3, 1.4, 4.1, 4.2, 12.1, 12.2. Annex X clause 2.1 – 3 rd indent refers to “one model of each category”. This model is a representative sample that displays all the major hazards identified with the machinery. For purposes of conformity assessment to Annex X, the Notify Body shall select a model that represents the most complex machine in each category form the complete list of the products manufactured.		

(1) Essential safety requirement

Note: According to point 6.6 of the Guide of the implementation of directives based on the New Approach and the Global Approach, the notified bodies apply as general guidance this recommendation for use.

	CO-ORDINATION OF NOTIFIED BODIES Machinery Directive 2006/42/EC + Amendment RECOMMENDATION FOR USE	CNB/M/13.006 Revision 02 Language: E
Date of first stage: 08/10/2007	To be approved by:	Approved on:
Origin: VG13 Full quality assurance	<input checked="" type="checkbox"/> Vertical Group <input checked="" type="checkbox"/> Horizontal Committee To be endorsed by: <input checked="" type="checkbox"/> Machinery Working Group....	17/09/2007 04/12/2007 Endorsed on: 04/06/2008
Question related to: Directive 2006/42/EC Article: Annex: X clause 2.1 – 3 rd indent ESR (1):	EN/prEN: Clause: CEN TC concerned:	Other: Other clause:
Key words: EC declaration of conformity, technical file		
Question: Is it necessary to get a copy of the EC-declaration?		
Solution: Yes. A copy of the EC declaration of conformity is a component of the technical file. That is why the applicant should submit a draft of the EC declaration of conformity to the NB.		

(1) Essential safety requirement

Note: According to point 6.6 of the Guide of the implementation of directives based on the New Approach and the Global Approach, the notified bodies apply as general guidance this recommendation for use.

	<p>CO-ORDINATION OF NOTIFIED BODIES Machinery Directive 2006/42/EC + Amendment</p> <p>RECOMMENDATION FOR USE</p>	<p>CNB/M/13.007 Revision 03</p> <p>Language: E</p>
<p>Date of first stage: 28/01/2008</p>	<p>To be approved by:</p>	<p>Approved on:</p>
<p>Origin: VG13 Full quality assurance</p>	<p><input checked="" type="checkbox"/> Vertical Group</p> <p><input checked="" type="checkbox"/> Horizontal Committee</p> <p>To be endorsed by:</p> <p><input checked="" type="checkbox"/> Machinery Working Group....</p>	<p>17/09/2007</p> <p>04/12/2007</p> <p>Endorsed on:</p> <p>04/06/2008</p>
<p>Question related to: Directive 2006/42/EC Article:</p> <p>Annex: X clause 2.1 - 3rd indent ESR (1):</p>	<p>EN/prEN:</p> <p>Clause:</p> <p>CEN TC concerned:</p>	<p>Other:</p> <p>Other clause:</p>
<p>Key words: technical file, assessment on site, quality system</p>		
<p>Question:</p> <p>When does the technical file have to be made available to the NB?</p>		
<p>Solution:</p> <p>The technical file shall be made available to the NB before the assessment on site of the manufacturer is carried out. This is necessary, because the technical file will be used to validate the output of the quality system. The assessment of the quality system can only be positively finished if also the review of the technical file is positively finished. For this reason it is a recommendation for the machine manufacturer to submit the technical file as soon as possible.</p> <p>Note: When the NB has an experience on technical files related to specific categories of this manufacturer it may take it into account for the assessment of the technical files.</p>		

(1) Essential safety requirement

Note: According to point 6.6 of the Guide of the implementation of directives based on the New Approach and the Global Approach, the notified bodies apply as general guidance this recommendation for use.

	CO-ORDINATION OF NOTIFIED BODIES Machinery Directive 2006/42/EC + Amendment RECOMMENDATION FOR USE	CNB/M/13.008 Revision 02 Language: E
Date of first stage: 08/10/2007	To be approved by:	Approved on:
Origin: VG13 Full quality assurance	<input checked="" type="checkbox"/> Vertical Group <input checked="" type="checkbox"/> Horizontal Committee To be endorsed by: <input checked="" type="checkbox"/> Machinery Working Group....	17/09/2007 04/12/2007 Endorsed on: 04/06/2008
Question related to: Directive 2006/42/EC Article: Annex: X clause 2.1 - 3 rd indent ESR (1):	EN/prEN: Clause: CEN TC concerned:	Other: Other clause:
Key words: complete technical file, documentation, complex machinery, audit		
Question: Does the complete technical file have to be made available?		
Solution: Yes. The complete technical file has to be made available to show that the quality system is capable of generating sufficient and complete documentation output according to the requirements of Annex VII, Part A. For complex machinery, it might be difficult to submit a very voluminous and complete technical file before the audit on site. The content of the documentation to be sent before the audit can be reduced in agreement with the NB. During the audit all the elements of the technical file must be available.		

(1) Essential safety requirement

Note: According to point 6.6 of the Guide of the implementation of directives based on the New Approach and the Global Approach, the notified bodies apply as general guidance this recommendation for use.

	CO-ORDINATION OF NOTIFIED BODIES Machinery Directive 2006/42/EC + Amendment RECOMMENDATION FOR USE	CNB/M/13.009 Revision 04 Language: E
Date of first stage: 28/01/2008	To be approved by:	Approved on:
Origin: VG13 Full quality assurance	<input checked="" type="checkbox"/> Vertical Group <input checked="" type="checkbox"/> Horizontal Committee To be endorsed by: <input checked="" type="checkbox"/> Machinery Working Group....	17/09/2007 10/06/2008 Endorsed on: 08/01/2009
Question related to: Directive 2006/42/EC Article: Annex: X clause 2.1 - 4 th indent ESR (1):	EN/prEN: Clause: CEN TC concerned:	Other: Other clause:
Key words: quality system documentation, quality management manual, certificates, audit reports, language		
Question: Shall the complete documentation according to Annex X clause 2.2 of the quality system be submitted to the Notified Body prior to the audit?		
Solution: No, the applicant must make available a controlled copy of his quality management manual or any other type of documentation acceptable to the Notified Body (NB) in due time before the audit. This need not include all detailed processes but will focus on the procedures which were specifically developed in order to comply with the requirements of the directive. During the audit the complete documentation according to Annex X clause 2.2 must be checked. The language of the provided documentation must be acceptable to the NB. If the applicant requires the NB to take into account some elements already certified by another NB and or an accredited certification body, he shall provide the related certificates. Where appropriate the NB may require to review audit reports produced during the three last years.		

(1) Essential safety requirement

Note: According to point 6.6 of the Guide of the implementation of directives based on the New Approach and the Global Approach, the notified bodies apply as general guidance this recommendation for use.

	CO-ORDINATION OF NOTIFIED BODIES Machinery Directive 2006/42/EC + Amendment RECOMMENDATION FOR USE	CNB/M/13.010 Revision 04 Language: E
Date of first stage: 08/05/2008	To be approved by:	Approved on:
Origin: VG13 Full quality assurance	<input checked="" type="checkbox"/> Vertical Group <input checked="" type="checkbox"/> Horizontal Committee To be endorsed by: <input checked="" type="checkbox"/> Machinery Working Group....	17/09/2007 10/06/2008 Endorsed on: 08/01/2009
Question related to: Directive 2006/42/EC Article: Annex: X clause 2.2 - 3 rd indent ESR (1):	EN/prEN: Clause: CEN TC concerned:	Other: Other clause:
Key words: technical design specification, sample, manufacturing facilities, inspections, audit plan		
Question: What is the role of the Notified Body of reviewing the technical design specifications?		
Solution: During the assessment of the quality system, the Notified Body will at first verify that the harmonised standards used by the manufacturer are the correct ones with regard to the different categories of machinery presented by the manufacturer. Care will be taken about the fact that there might be necessary to use different standards to cover the various types of machinery within one category. The Notified Body will also pay attention to the procedures developed by the manufacturer in order to ensure that he uses the latest version of the relevant standard. If harmonised standards are not used, or are partially used the Notified Body will evaluate the adequacy of the principles developed in order to demonstrate compliance with the requirements of the directive (see also CNB/M/13.009). The control of the effectiveness of these principles is made by the assessment of the technical file.		

(1) Essential safety requirement

Note: According to point 6.6 of the Guide of the implementation of directives based on the New Approach and the Global Approach, the notified bodies apply as general guidance this recommendation for use.

	CO-ORDINATION OF NOTIFIED BODIES Machinery Directive 2006/42/EC + Amendment RECOMMENDATION FOR USE	CNB/M/13.011 Revision 04 Language: E
Date of first stage: 28/01/2008	To be approved by:	Approved on:
Origin: VG13 Full quality assurance	<input checked="" type="checkbox"/> Vertical Group <input checked="" type="checkbox"/> Horizontal Committee To be endorsed by: <input checked="" type="checkbox"/> Machinery Working Group....	17/09/2007 10/06/2008 Endorsed on: 08/01/2009
Question related to: Directive 2006/42/EC Article: Annex: X clause 2.2 - 2 nd indent ESR (1):	EN/prEN: Clause: CEN TC concerned:	Other: Other clause:
Key words: harmonized standards, responsibility, design review		
Question: What is the role of the Notified Body for the assessment of the technical design specifications that do not comply fully with harmonized standards?		
Solution: The Notified Body has to evaluate, whether the strategy for the selected means of the manufacturer is adequate to fulfil the requirements of the machinery directive. The manufacturer has to document the parts of a design which do not fully comply with harmonized standards and has to describe and justify (e.g. by risk assessment, use of approved practice, testing) the means that will be used to ensure that the essential health and safety requirements are fulfilled at least at an equivalent level of safety.		

(1) Essential safety requirement

Note: According to point 6.6 of the Guide of the implementation of directives based on the New Approach and the Global Approach, the notified bodies apply as general guidance this recommendation for use.

	CO-ORDINATION OF NOTIFIED BODIES Machinery Directive 2006/42/EC + Amendment RECOMMENDATION FOR USE	CNB/M/13.012 Revision 05 Language: E
Date of first stage: 28/01/2008 Origin: VG13 Full quality assurance	To be approved by: <input checked="" type="checkbox"/> Vertical Group <input checked="" type="checkbox"/> Horizontal Committee To be endorsed by: <input checked="" type="checkbox"/> Machinery Working Group....	Approved on: 23/10/2012 (*) 10/06/2008 Endorsed on: 08/01/2009
Question related to: Directive 2006/42/EC Article: Annex: X clause 2.2 - 3 rd indent ESR (1):	EN/prEN: Clause: CEN TC concerned:	Other: Other clause:
Key words: design inspection, design verification, independence, level of confidence		
Question: Has the design inspection and design verification to be done by an independent person or department of the manufacturer?		
Solution: No, unless it is required by the quality system of the manufacturer or an applied standard. This directive, and others such as the PE-Directive and Lift Directive, and the current issue of the standard ISO 9001 do not explicitly require independence of persons or departments carrying out the design inspection and review. The manufacturer shall at least define responsibilities and competence for these persons and traceability of their actions. The manufacturer shall plan the inspection and review which shall be carried out under controlled conditions (instructions, checklists etc.). The final inspection shall include checking whether the design inspection and review has been performed correctly. Note: It is good practice to have design inspection and design verification performed by a person not directly involved in this design process. (*) Updating – to remove reference to an out of date version of ISO 9001		

(1) Essential safety requirement

Note: According to point 6.6 of the Guide of the implementation of directives based on the New Approach and the Global Approach, the notified bodies apply as general guidance this recommendation for use.

	CO-ORDINATION OF NOTIFIED BODIES Machinery Directive 2006/42/EC + Amendment RECOMMENDATION FOR USE	CNB/M/13.013 Revision 03 Language: E
Date of first stage: 28/01/2008 Origin: VG13 Full quality assurance	To be approved by: <input checked="" type="checkbox"/> Vertical Group <input checked="" type="checkbox"/> Horizontal Committee To be endorsed by: <input checked="" type="checkbox"/> Machinery Working Group....	Approved on: 17/09/2007 04/12/2007 Endorsed on: 04/06/2008
Question related to: Directive 2006/42/EC Article: Annex: X clause 2.2 - 3 rd indent and clause 2.3 - 1 st sentence ESR (1):	EN/prEN: Clause: CEN TC concerned:	Other: Other clause:
Key words: product complexity, validation, competence		
Question: How shall the NB consider the complexity of the product?		
Solution: The complexity of annex IV products may vary substantially. A circular saw with electro-mechanical control components only is for example less complex than a Logic Unit to ensure safety functions realized with several microprocessors (hardware and software) to control a work tool machine. The validation of the applied design process and the validation of the specific product need an adequate level of detail and therefore an adequate amount of time, which means that the conformity assessment process needs more time for complex products. At least one of the members of the audit team shall have appropriate competence in the technical field and in the corresponding ESHR of the MD.		

(1) Essential safety requirement

Note: According to point 6.6 of the Guide of the implementation of directives based on the New Approach and the Global Approach, the notified bodies apply as general guidance this recommendation for use.

	<p>CO-ORDINATION OF NOTIFIED BODIES Machinery Directive 2006/42/EC + Amendment</p> <p>RECOMMENDATION FOR USE</p>	<p>CNB/M/13.014 Revision 04</p> <p>Language: E</p>
<p>Date of first stage: 28/01/2008</p>	<p>To be approved by:</p> <p><input checked="" type="checkbox"/> Vertical Group.....</p> <p><input checked="" type="checkbox"/> Horizontal Committee</p>	<p>Approved on:</p> <p>17/09/2007</p> <p>10/06/2008</p>
<p>Origin: VG13 Full quality assurance</p>	<p>To be endorsed by:</p> <p><input checked="" type="checkbox"/> Machinery Working Group....</p>	<p>Endorsed on:</p> <p>08/01/2009</p>
<p>Question related to: Directive 2006/42/EC Article:</p> <p>Annex: X clause 2.2 - 6th indent; ESR (1): clause 2.3 - 1st sentence</p>	<p>EN/prEN:</p> <p>Clause:</p> <p>CEN TC concerned:</p>	<p>Other:</p> <p>Other clause:</p>
<p>Key words: competency qualification of personnel, product specific requirements</p>		
<p>Question:</p> <p>How shall the Notified Body assess the qualifications of the manufacturer's personnel?</p>		
<p>Solution:</p> <p>The Notified Body shall ensure that records are available to demonstrate the competencies of personnel undertaking tasks which could affect the conformance of the product with the relevant legislation/standards. Competency shall include, but not be limited to, product knowledge, experience of particular processes and awareness of the applicable quality system procedures, the relevant standards and the directive.</p>		

(1) Essential safety requirement
Note: According to point 6.6 of the Guide of the implementation of directives based on the New Approach and the Global Approach, the notified bodies apply as general guidance this recommendation for use.

	CO-ORDINATION OF NOTIFIED BODIES Machinery Directive 2006/42/EC + Amendment RECOMMENDATION FOR USE	CNB/M/13.015 Revision 04 Language: E
Date of first stage: 28/01/2008	To be approved by:	Approved on:
Origin: VG13 Full quality assurance	<input checked="" type="checkbox"/> Vertical Group <input checked="" type="checkbox"/> Horizontal Committee To be endorsed by: <input checked="" type="checkbox"/> Machinery Working Group....	17/09/2007 10/06/2008 Endorsed on: 08/01/2009
Question related to: Directive 2006/42/EC Article: Annex: X clause 2.2 - 7 th indent; ESR (1): clause 2.3 - 1 st sentence	EN/prEN: Clause: CEN TC concerned:	Other: Other clause:
Key words: machinery design, quality, compliance		
Question: How shall the Notified Body assess the means of monitoring the achievement of the required design and quality of the machinery?		
Solution: There are two parts to this question: In the first instance, the Notified Body (NB) has to check demonstrated "design" compliance with the requirement of the machinery directive. This compliance is assessed by sampling, mainly by examination of the representative technical files as defined by Annex X of the directive. In addition to the ability of the manufacturer to prepare an adequate technical file, it is important to assess the procedures developed in order to ensure that the different versions of the machinery will still comply with the requirements, taking into account the evolution of the state of the art. In the second instance, the NB has to check the existence and application of procedures for effective control of the conformity of produced machinery to the "approved" design. These procedures must also ensure monitoring of subcontracted and/or licensed design and production. The manufacturer has to ensure that test or check result data are recorded and that annexed documents remain available for a period of ten years from the last date of manufacture of that product.		

(1) Essential safety requirement

Note: According to point 6.6 of the Guide of the implementation of directives based on the New Approach and the Global Approach, the notified bodies apply as general guidance this recommendation for use.

	CO-ORDINATION OF NOTIFIED BODIES Machinery Directive 2006/42/EC + Amendment RECOMMENDATION FOR USE	CNB/M/13.016 Revision 05 Language: E
Date of first stage: 2/01/2008	To be approved by:	Approved on:
Origin: VG13 Full quality assurance	<input checked="" type="checkbox"/> Vertical Group <input checked="" type="checkbox"/> Horizontal Committee To be endorsed by: <input checked="" type="checkbox"/> Machinery Working Group....	23/10/2012 (*) 10/06/2008 Endorsed on: 08/01/2009
Question related to: Directive 2006/42/EC Article: Annex: X clause 2.3 ESR (1):	EN/prEN: Clause: CEN TC concerned:	Other: Other clause:
Key words: existing certification, conformance, certified quality system		
Question: Can the NB fully rely on an existing certificate (e.g. for ISO 9001)?		
Solution: No. A quality system certified to ISO 9001 alone cannot be considered adequate to demonstrate conformance with the requirements of Annex X. An ISO 9001 certified quality system must be adapted to integrate the additional requirements of the Machinery Directive (in particular Annex X) , but it is up to the Notified Body (NB) undertaking the assessment to determine the extent to further modification. Only a NB can issue certification of conformance with Annex X of the Machinery Directive and such NBs must take full and sole responsibility for such certification. (*) Updating – to remove reference to an out of date version of ISO 9001		

(1) Essential safety requirement

Note: According to point 6.6 of the Guide of the implementation of directives based on the New Approach and the Global Approach, the notified bodies apply as general guidance this recommendation for use.

	CO-ORDINATION OF NOTIFIED BODIES Machinery Directive 2006/42/EC + Amendment RECOMMENDATION FOR USE	CNB/M/13.017 Revision 02 Language: E
Date of first stage: 08/10/2007	To be approved by:	Approved on:
Origin: VG13 Full quality assurance	<input checked="" type="checkbox"/> Vertical Group <input checked="" type="checkbox"/> Horizontal Committee To be endorsed by: <input checked="" type="checkbox"/> Machinery Working Group....	17/09/2007 04/12/2007 Endorsed on: 04/06/2008
Question related to: Directive 2006/42/EC Article: Annex: X clause 2.3 ESR (1):	EN/prEN: Clause: CEN TC concerned:	Other: Other clause:
Key words: auditors, experts, competence		
Question: Must the team of the auditors consist of at least two persons?		
Solution: No. The number of auditors shall be adequate for the size of the company or the number of the people involved and the complexity and number of categories of machinery. If the auditor's competence does not cover the scope, additional experts shall accompany the auditor(s). In this context the expert(s) shall not be regarded as an auditor.		

(1) Essential safety requirement

Note: According to point 6.6 of the Guide of the implementation of directives based on the New Approach and the Global Approach, the notified bodies apply as general guidance this recommendation for use.

	CO-ORDINATION OF NOTIFIED BODIES Machinery Directive 2006/42/EC + Amendment RECOMMENDATION FOR USE		CNB/M/13.018 Revision 02 Language: E
Date of first stage: 08/10/2007	To be approved by:		Approved on:
Origin: VG13 Full quality assurance	<input checked="" type="checkbox"/> Vertical Group <input checked="" type="checkbox"/> Horizontal Committee To be endorsed by: <input checked="" type="checkbox"/> Machinery Working Group....		17/09/2007 04/12/2007 Endorsed on: 04/06/2008
Question related to: Directive 2006/42/EC Article: Annex: X clause 2.3 ESR (1):	EN/prEN: Clause: CEN TC concerned:		Other: Other clause:
Key words: EHSR, technical file, review			
Question: How deep shall the review of the technical file be if its purpose is to ensure its compliance with the relevant HSR?			
Solution: Compliance with the essential health and safety requirements can only be ensured, if the technical file is reviewed in a similar manner to that required for module B, but without a detailed product inspection.			

(1) Essential safety requirement

Note: According to point 6.6 of the Guide of the implementation of directives based on the New Approach and the Global Approach, the notified bodies apply as general guidance this recommendation for use.

	CO-ORDINATION OF NOTIFIED BODIES Machinery Directive 2006/42/EC + Amendment RECOMMENDATION FOR USE	CNB/M/13.019 Revision 04 Language: E
Date of first stage: 28/01/2008	To be approved by:	Approved on:
Origin: VG13 Full quality assurance	<input checked="" type="checkbox"/> Vertical Group <input checked="" type="checkbox"/> Horizontal Committee To be endorsed by: <input checked="" type="checkbox"/> Machinery Working Group....	17/09/2007 10/06/2008 Endorsed on: 08/01/2009
Question related to: Directive 2006/42/EC Article: Annex: X clause 2.4 ESR (1):	EN/prEN: Clause: CEN TC concerned:	Other: Other clause:
Key words: product changes, changes of quality system, significant changes, contract		
Question: Is the planned change of the product covered by the planned change of the quality system?		
Solution: One of the tasks of a Notified Body (NB) in assessing and approving a full quality system is to review the technical file(s) for one model of each category of machinery referred to in Annex IV. A change of the quality system does not necessarily cause a change in the product nor - conversely - does a change of the machinery necessarily result in a change of the quality system. So the manufacturer shall only inform the NB about significant changes of the relevant technical files which may have implications on the quality system as well as direct changes of the quality system. It is recommended that contractual agreement between the NB and the manufacturer foresees the duty of the manufacturer to provide information on product changes and new products to the NB.		

(1) Essential safety requirement

Note: According to point 6.6 of the Guide of the implementation of directives based on the New Approach and the Global Approach, the notified bodies apply as general guidance this recommendation for use.

	CO-ORDINATION OF NOTIFIED BODIES Machinery Directive 2006/42/EC + Amendment RECOMMENDATION FOR USE	CNB/M/13.020 Revision 04 Language: E
Date of first stage: 28/01/2008	To be approved by:	Approved on:
Origin: VG13 Full quality assurance	<input checked="" type="checkbox"/> Vertical Group <input checked="" type="checkbox"/> Horizontal Committee To be endorsed by: <input checked="" type="checkbox"/> Machinery Working Group....	17/09/2007 10/06/2008 Endorsed on: 08/01/2009
Question related to: Directive 2006/42/EC Article: Annex: X clause 2.3 ESR (1):	EN/prEN: Clause: CEN TC concerned:	Other: Other clause:
Key words: notification, report, certificate		
Question: How should a Notified Body notify its decision?		
Solution: <p>The Notified Body (NB) shall inform the Manufacturer or Authorised Representative of their assessment decision following the visit via a written report and/or an approval certificate. If this is not provided at the end of the assessment visit itself, the written report of findings and/or approval certificate should be submitted to the Manufacturer or Authorised Representative within a reasonable timeframe, normally within one month. Where approval certification is being withheld, the written report shall contain sufficient information and reasoned judgement to enable the Manufacturer or Authorised Representative to identify and take appropriate corrective action prior to requesting a further assessment visit. Whether issued via written report or an approval certificate, the NB shall ensure that certification is supported by a scope of approval, this will define exactly what has been approved in terms of products, manufacturing locations and any particular limitations.</p>		

(1) Essential safety requirement

Note: According to point 6.6 of the Guide of the implementation of directives based on the New Approach and the Global Approach, the notified bodies apply as general guidance this recommendation for use.

	CO-ORDINATION OF NOTIFIED BODIES Machinery Directive 2006/42/EC + Amendment RECOMMENDATION FOR USE	CNB/M/13.021 Revision 04 Language: E
Date of first stage: 28/01/2008 Origin: VG13 Full quality assurance	To be approved by: <input checked="" type="checkbox"/> Vertical Group <input checked="" type="checkbox"/> Horizontal Committee To be endorsed by: <input checked="" type="checkbox"/> Machinery Working Group....	Approved on: 17/09/2007 10/06/2008 Endorsed on: 08/01/2009
Question related to: Directive 2006/42/EC Article: Annex: X clause 3.3 ESR (1):	EN/prEN: Clause: CEN TC concerned:	Other: Other clause:
Key words: audit frequency and duration, surveillance audits		
Question: How often have surveillance audits to be done by Notified Bodies?		
Solution: The period between the audits should not be longer than 12 months. The duration and frequency of surveillance audits shall be determined by the Notified Body taking into account the complexity of the Manufacturer (e.g. number of sites, complexity of manufacturing processes, how much work is sub-contracted etc.), the products involved (e.g. the number and variety of individual products) and production volumes (e.g. higher volumes may require more frequent/longer visits). Also the former experience with this manufacturer may influence the duration and frequency of surveillance audits.		

(1) Essential safety requirement

Note: According to point 6.6 of the Guide of the implementation of directives based on the New Approach and the Global Approach, the notified bodies apply as general guidance this recommendation for use.

	CO-ORDINATION OF NOTIFIED BODIES Machinery Directive 2006/42/EC + Amendment RECOMMENDATION FOR USE	CNB/M/13.022 Revision 02 Language: E
Date of first stage: 08/10/2007	To be approved by:	Approved on:
Origin: VG13 Full quality assurance	<input checked="" type="checkbox"/> Vertical Group <input checked="" type="checkbox"/> Horizontal Committee To be endorsed by: <input checked="" type="checkbox"/> Machinery Working Group....	17/09/2007 04/12/2007 Endorsed on: 04/06/2008
Question related to: Directive 2006/42/EC Article: Annex: X clause 3.4 ESR (1):	EN/prEN: Clause: CEN TC concerned:	Other: Other clause:
Key words: unannounced visits, contracts		
Question: Are there additional conditions for unannounced visits?		
Solution: <p>Annex X of the directive indicates some of the reasons which might induce the need of unannounced visits. The frequency of these visits is a matter for the NB to determine at its discretion and, as appropriate following co-ordination with other notified bodies, but should not be unreasonable.</p> <p>A duly motivated complaint made to the NB by the Commission, a Member State, a manufacturer, another NB or any interested party is one of the factors which could trigger the need for an unexpected visit.</p> <p>It is recognised that the NB may carry out tests (or have them carried out) on the product where this is necessary to verify the quality system. Such tests should generally be confined to instances where clear evidence demonstrates that there is reasonable doubt about the effectiveness of the quality system to ensure that the machinery made under it conforms to the essential requirements of the directive.</p> <p>It is recommended that contractual agreement between the NB and the manufacturer foresees the possibility of these visits.</p>		

(1) Essential safety requirement

Note: According to point 6.6 of the Guide of the implementation of directives based on the New Approach and the Global Approach, the notified bodies apply as general guidance this recommendation for use.

	CO-ORDINATION OF NOTIFIED BODIES Machinery Directive 2006/42/EC + Amendment RECOMMENDATION FOR USE	CNB/M/13.023 Revision 04 Language: E
Date of first stage: 08/10/2007	To be approved by:	Approved on:
Origin: VG13 Full quality assurance	<input checked="" type="checkbox"/> Vertical Group <input checked="" type="checkbox"/> Horizontal Committee To be endorsed by: <input checked="" type="checkbox"/> Machinery Working Group....	12/05/2009 10/06/2009 Endorsed on: 25/12/2009
Question related to: Directive 2006/42/EC Article: Annex: X clause 4 ESR (1):	EN/prEN: Clause: CEN TC concerned:	Other: Other clause:
Key words: obligation to preserve		
Question: Does only the technical file referenced in 2.1 of Annex X need to be kept available for the national authorities, for a period of ten years?		
Solution: No. Conformity with Annex X does not remove the general duties of the manufacturer as defined in Annex VII A. clause 2 (all technical files should be made available to the authorities for at least 10 years).		

(1) Essential safety requirement

Note: According to point 6.6 of the Guide of the implementation of directives based on the New Approach and the Global Approach, the notified bodies apply as general guidance this recommendation for use.

	CO-ORDINATION OF NOTIFIED BODIES Machinery Directive 2006/42/EC + Amendment RECOMMENDATION FOR USE		CNB/M/13.024 Revision 04 Language: E
Date of first stage: 28/01/2008	To be approved by:		Approved on:
Origin: VG13 Full quality assurance	<input checked="" type="checkbox"/> Vertical Group <input checked="" type="checkbox"/> Horizontal Committee	17/09/2007 10/06/2008	
		To be endorsed by:	Endorsed on:
		<input checked="" type="checkbox"/> Machinery Working Group....	08/01/2009
Question related to: Directive 2006/42/EC	Article:	EN/prEN:	Other:
Annex: X clause 4	ESR (1):	Clause:	Other clause:
Key words: obligation to preserve, quality assurance system documentation			
Question: Shall the Notified Body check whether a manufacturer of the machine keeps each version of the quality assurance system documentation for at least 10 years?			
Solution: Yes, the Notified Body must check whether a machine manufacturer keeps all versions of his quality assurance system which has had an effect on any Annex IV product for at least ten years after the last of those products was manufactured.			

(1) Essential safety requirement

Note: According to point 6.6 of the Guide of the implementation of directives based on the New Approach and the Global Approach, the notified bodies apply as general guidance this recommendation for use.

	CO-ORDINATION OF NOTIFIED BODIES Machinery Directive 2006/42/EC + Amendment RECOMMENDATION FOR USE	CNB/M/13.025 Revision 04 Language: E
Date of first stage: 28/01/2008	To be approved by:	Approved on:
Origin: VG13 Full quality assurance	<input checked="" type="checkbox"/> Vertical Group	17/09/2007
	<input checked="" type="checkbox"/> Horizontal Committee	10/06/2008
Question related to: Directive 2006/42/EC Article: Annex: X clause 4 ESR (1):	To be endorsed by:	Endorsed on:
	<input checked="" type="checkbox"/> Machinery Working Group....	08/01/2009
	EN/prEN:	Other:
	Clause:	Other clause:
Key words: last date of manufacture		
Question: What is meant by the last date of manufacture as used in Annex X?		
Solution: The last date of manufacture is the date upon which the last of a 'defined product' type is CE Marked with the intention of placing it on the market (be this into service or the supply chain). 'Defined product' means one that has a specific and unique identification name/number and is identified as such within a particular Technical File. The relevant records shall then be retained for a period of ten years from this last date of manufacture.		

(1) Essential safety requirement

Note: According to point 6.6 of the Guide of the implementation of directives based on the New Approach and the Global Approach, the notified bodies apply as general guidance this recommendation for use.

	CO-ORDINATION OF NOTIFIED BODIES Machinery Directive 2006/42/EC + Amendment RECOMMENDATION FOR USE	CNB/M/13.026 Revision 02 Language: E
Date of first stage: 08/10/2007	To be approved by:	Approved on:
Origin: VG13 Full quality assurance	<input checked="" type="checkbox"/> Vertical Group	17/09/2007
	<input checked="" type="checkbox"/> Horizontal Committee	04/12/2007
Question related to: Directive 2006/42/EC Article: Annex: X ESR (1):	To be endorsed by:	Endorsed on:
	<input checked="" type="checkbox"/> Machinery Working Group....	04/06/2008
	EN/prEN:	Other:
	Clause:	Other clause:
	CEN TC concerned:	
Key words: audit frequency and duration, assessment		
Question: Is there a minimum requirement for the time to be allocated to the assessment?		
Solution: <p>The duration and frequency of assessment visits shall be determined by the NB taking into account the complexity of the Manufacturer (e.g. number of sites, complexity of manufacturing processes, how much work is sub-contracted etc.), the products involved (e.g. the number and variety of individual products) and production volumes (e.g. higher volumes may require more frequent/longer visits). Annex 2 of IAF Guide 62 should be used as a basis for determining a minimum baseline duration for the assessment visit (auditor time) to which additional time shall be added based upon experience gained from similar modules in other EC Directives.</p>		

(1) Essential safety requirement

Note: According to point 6.6 of the Guide of the implementation of directives based on the New Approach and the Global Approach, the notified bodies apply as general guidance this recommendation for use.

	CO-ORDINATION OF NOTIFIED BODIES Machinery Directive 2006/42/EC + Amendment RECOMMENDATION FOR USE		CNB/M/13.028 Revision 03 Language: E
Date of first stage: 08/05/2008 Origin: VG13 Full quality assurance	To be approved by: <input checked="" type="checkbox"/> Vertical Group <input checked="" type="checkbox"/> Horizontal Committee To be endorsed by: <input checked="" type="checkbox"/> Machinery Working Group....	Approved on: 17/09/2007 10/06/2008 Endorsed on: 08/01/2009	
Question related to: Directive 2006/42/EC Article: Annex: X clause 2.1 - 3 rd indent; ESR (1): clause 2.3 - 3 rd paragraph	EN/prEN: Clause: CEN TC concerned:	Other: Other clause:	
Key words: technical file, sample, manufacturing facilities, inspections, audit plan			
Question: What is the role of the Notified Body in the review of the technical file?			
Solution: The role of the Notified Body (NB) is to check whether the technical file fulfils the EHSR of the MD and to verify that the quality system can produce the product in conformance with the technical file. It is not the responsibility of the NB to test the product. When studying the technical file(s) submitted by the manufacturer, the NB prepares the audit and possible inspections at the places of design, manufacture, inspection, testing and storage. This will allow him to send an audit plan to the manufacturer before his assessment. There are two steps in the review of the technical file. <ol style="list-style-type: none"> 1. The NB will make a specific analysis of one technical file duly selected for each category of machinery and provided by the manufacturer in the context of section 2.1 – 3rd indent. 2. During the audit, the NB will also review the existing technical files according to section 2.3 – 3rd paragraph. The main purpose here is to check that the existing files are established with the same approach as the sample selected for deeper analysis. Note: For an annex X conformity assessment there will be no sample of the type of machinery to be examined at the site of the NB. All checks of samples to confirm compliance with the technical file have to be witnessed at the manufacturing facilities. A precondition to do these checks is the knowledge of the technical file of the representative model.			

(1) Essential safety requirement

Note: According to point 6.6 of the Guide of the implementation of directives based on the New Approach and the Global Approach, the notified bodies apply as general guidance this recommendation for use.

	<p>CO-ORDINATION OF NOTIFIED BODIES Machinery Directive 2006/42/EC + Amendment</p> <p>RECOMMENDATION FOR USE</p>	<p>CNB/M/13.029 Revision 03</p> <p>Language: E</p>
<p>Date of first stage: 21/08/2008</p> <p>Origin: VG13 Full quality assurance</p>	<p>To be approved by:</p> <p><input checked="" type="checkbox"/> Vertical Group</p> <p><input checked="" type="checkbox"/> Horizontal Committee</p> <p>To be endorsed by:</p> <p><input checked="" type="checkbox"/> Machinery Working Group....</p>	<p>Approved on:</p> <p>21/08/2008 09/12/2008</p> <p>Endorsed on:</p> <p>18/06/2009</p>
<p>Question related to: Directive 2006/42/EC Article:</p> <p>Annex: X ESR (1):</p>	<p>EN/prEN:</p> <p>Clause:</p> <p>CEN TC concerned:</p>	<p>Other:</p> <p>Other clause:</p>
<p>Key words: Subcontract</p>		
<p>Question:</p> <p>Is it possible for a Notified Body to subcontract to another Notified Body or another institution?</p>		
<p>Solution:</p> <p>Yes, it is permissible for a Notified Body to sub-contract some activities to another organisation including another NB or Subsidiary as defined within article R20 of the DECISION OF THE EUROPEAN PARLIAMENT AND OF THE COUNCIL ON A COMMON FRAMEWORK FOR THE MARKETING OF PRODUCTS 768/2008/CE:</p> <p>According to article 20, the original Notified Body must at least:</p> <ul style="list-style-type: none"> ○ ensure that the subcontractor or the subsidiary meets the requirements set out for Notified Bodies and inform the notifying authority of their use; ○ take full responsibility for the tasks performed by subcontractors or subsidiaries wherever these are established; ○ have the agreement of the client; ○ ensure the other institution is technically competent; ○ clearly define the task(s) to be performed by the other institution and establish a suitable contract; and ○ monitor the performance of the subcontractor or subsidiary.. <p>It should be noted that some Member States include within their terms of appointment a requirement for a Notified Body to advise them of all sub-contracted activities.</p>		

(1) Essential safety requirement

Note: According to point 6.6 of the Guide of the implementation of directives based on the New Approach and the Global Approach, the notified bodies apply as general guidance this recommendation for use.

	CO-ORDINATION OF NOTIFIED BODIES Machinery Directive 2006/42/EC + Amendment RECOMMENDATION FOR USE	CNB/M/13.030 Revision 03 Language: E
Date of first stage: 21/08/2008	To be approved by:	Approved on:
Origin: VG13 Full quality assurance	<input checked="" type="checkbox"/> Vertical Group <input checked="" type="checkbox"/> Horizontal Committee To be endorsed by: <input checked="" type="checkbox"/> Machinery Working Group....	21/08/2008 09/12/2008 Endorsed on: 18/06/2009
Question related to: Directive 2006/42/EC Article: Annex: X.3.3 ESR (1):	EN/prEN: Clause: CEN TC concerned:	Other: Other clause:
Key words: reassessment		
Question: How is re-assessment of the quality system achieved?		
Solution: The directive indicates that “the frequency of periodic audits shall be such that a full reassessment is carried out every three years”. This requirement gives two possibilities for reassessment: <ol style="list-style-type: none"> 1. The NB issues an approval certificate valid for a period of three years and embarks of a surveillance programme, including periodic audits, which ensure that all aspects of the quality system are assessed within the three years of validity. Prior to expiry of the approval certificate, the NB reviews the audits performed during that period and if this is considered satisfactory, it issues a new approval certificate valid for a further three years. or 2. The NB issues an approval certificate valid for a period of three years and embarks of a surveillance programme including periodic audits. Prior to expiry of the approval certificate the NB arranges to attend the manufacturers to perform a full reassessment of the quality system. If the assessment is found to be acceptable a new approval certificate, valid for a period of three years, is issued. Note: Where the NB holds accreditation to EN ISO/IEC 17021, option 1 may not be permissible.		

(1) Essential safety requirement

Note: According to point 6.6 of the Guide of the implementation of directives based on the New Approach and the Global Approach, the notified bodies apply as general guidance this recommendation for use.

	<p>CO-ORDINATION OF NOTIFIED BODIES Machinery Directive 2006/42/EC + Amendment</p> <p>RECOMMENDATION FOR USE</p>	<p>CNB/M/13.033 Revision 04</p> <p>Language: E</p>
Date of first stage: 21/08/2008	To be approved by:	Approved on:
Origin: VG13 Full quality assurance	<input checked="" type="checkbox"/> Vertical Group <input checked="" type="checkbox"/> Horizontal Committee	23/10/2012 (*) 09/12/2008
	To be endorsed by:	Endorsed on:
Question related to: Directive 2006/42/EC Article: Annex: X. 2.3. ESR (1):	<input checked="" type="checkbox"/> Machinery Working Group....	18/06/2009
Question related to: Directive 2006/42/EC	EN/prEN:	Other:
Annex: X. 2.3.	Clause:	Other clause:
	CEN TC concerned:	
Key words: quality system, audit plan		
Question: What kind of documentation is to be delivered to the manufacturer by the Notified Body (audit plan)?		
Solution: The programming and planning of audits is an essential process to satisfy the needs and expectations of both Notified Body and applicant. An audit plan should be sent to the manufacturer. The audit plan should cover <ul style="list-style-type: none"> - Identification of the applicable standard (for instance ISO 9001) and type of audit (initial assessment, surveillance...) - The dates of the audit - The planned duration of each significant audit event - Indication of the activities and clauses to be audited. Depending on the results of previous surveillance visits, focus can be set on some parts of the quality system concerned with design and/or manufacture (results of calculations, reports on the qualification of the personnel concerned) - Identification of the audit team members - Identification of the language of the audit - Indication of the sites to be audited The audit plan should be sent to the client at least five working days prior to the audit. <p>(*) Updating – to remove reference to an out of date version of ISO 9001</p>		

(1) Essential safety requirement

Note: According to point 6.6 of the Guide of the implementation of directives based on the New Approach and the Global Approach, the notified bodies apply as general guidance this recommendation for use.

	CO-ORDINATION OF NOTIFIED BODIES Machinery Directive 2006/42/EC + Amendment RECOMMENDATION FOR USE	CNB/M/13.034 Revision 04 Language: E
Date of first stage: 21/08/2008	To be approved by:	Approved on:
Origin: VG13 Full quality assurance	<input checked="" type="checkbox"/> Vertical Group <input checked="" type="checkbox"/> Horizontal Committee	12/05/2009 10/06/2009
	To be endorsed by: <input checked="" type="checkbox"/> Machinery Working Group....	Endorsed on: 25/12/2009
Question related to: Directive 2006/42/EC Article: Annex: X ESR (1):	EN/prEN: Clause: CEN TC concerned:	Other: Other clause:
Key words: certificate		
Question: What are the minimum contents of an Annex X approval certificate?		
Solution: A certificate of an Annex X approval of a quality assurance system shall contain as a minimum, the; <ul style="list-style-type: none"> ○ manufacturers name and address; ○ scope of approval, including category and/or sub-category of machines according to Annex IV and generic product description ○ limitations of the approval (if any); ○ date of issue; ○ date of expiry; ○ issuing Notified Body; and ○ person within the Notified Body authorising the certificate ○ names and addresses of the sites which have been assessed. The above reflects the minimum information necessary, but is not an exhaustive list. An example certificate is attached to this RfU. The names and addresses of the sites assessed shall be listed in an annex to the certificate.		

(1) Essential safety requirement
 Note: According to point 6.6 of the Guide of the implementation of directives based on the New Approach and the Global Approach, the notified bodies apply as general guidance this recommendation for use.

Example Certificate

EC APPROVAL OF A QUALITY ASSURANCE SYSTEM

In accordance with the requirements of the
Machinery Directive 2006/42/EC

This is to certify that the Full Quality Assurance System of:

<Company Name>

<Company Address>

<Company Address>

has been assessed against the requirements of Annex X of Machinery Directive 2006/42/EC and conforms to the requirements for the following scope of approval:

Design and manufacture of <generic product description and any applicable limitations>

This certificate is only valid when accompanied by a current schedule with the same number detailing the categories of machinery corresponding to this approval.

Approval is subject to the continued surveillance of the Full Quality Assurance System in accordance with the requirements of the above Directive. Unauthorised changes to the Full Quality Assurance System will render this approval invalid.

Authorisation is hereby given to use the Notified Body Identification Number in accordance with the requirements of the specified Directive in relation to the categories of machinery identified in this certificate and accompanying schedule.

Certificate No: <Certificate Number>

Original Approval: <Original Issue Date>

Current Certificate: <Subsequent Issue Date>

Certificate Expiry: <Expiry Date>

Notified Body Number <NB Number>

Issued by: <NB Signatory>

EC APPROVAL OF A QUALITY ASSURANCE SYSTEM
CERTIFICATE <Certificate Number> SCHEDULE

In accordance with the requirements of the
Machinery Directive 2006/42/EC

<Company Name>
<Company Address>
<Company Address>

Only the following specific categories of machinery (as defined within Annex IV of the above Directive) are covered by this approval of a quality assurance system:

Annex IV Clau se	Category Description

Schedule Issue: <Schedule Number>

Date of Schedule Issue: <Schedule Date>

Notified Body Number <NB Number>

Issued by: <NB Signatory>

	CO-ORDINATION OF NOTIFIED BODIES Machinery Directive 2006/42/EC + Amendment RECOMMENDATION FOR USE	CNB/M/13.037 Revision 03 Language: E
Date of first stage: 12/05/2009	To be approved by:	Approved on:
Origin: VG13 Full quality assurance	<input checked="" type="checkbox"/> Vertical Group	12/05/2009
	<input checked="" type="checkbox"/> Horizontal Committee	10/06/2009
Question related to: Directive 2006/42/EC Article: Annex: X clause 3.2 ESR (1):	To be endorsed by:	Endorsed on:
	<input checked="" type="checkbox"/> Machinery Working Group....	25/12/2009
	EN/prEN:	Other:
Key words: surveillance, quality system, technical file	Clause:	Other clause:
Question: According to Annex X, 2.1 the manufacturer has to lodge an application for assessment of this quality system containing the technical file for one model of each category of machinery he intends to manufacture. Is it acceptable if in the process of approval of the technical file there is no possibility to see the product during the assessment of the quality system by the Notified Body?	CEN TC concerned:	
	Solution: No. At the very first audit the NB has to see at least one model of each category of machinery to assess the full quality assurance system. Where this model is different from the technical file that was audited a model of equivalent complexity has to be assessed at least once during each period of three years.	

(1) Essential safety requirement

Note: According to point 6.6 of the Guide of the implementation of directives based on the New Approach and the Global Approach, the notified bodies apply as general guidance this recommendation for use.

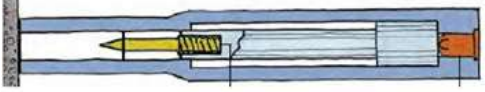
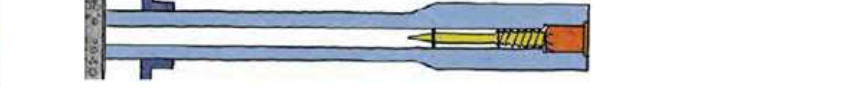
	CO-ORDINATION OF NOTIFIED BODIES Machinery Directive 2006/42/EC + Amendment RECOMMENDATION FOR USE	CNB/M/14.001 Revision 03 Language: E
Date of first stage: 17.10.2013	To be approved by:	Approved on:
Origin: VG 14 Portable cartridge-operated fixing and other impact machinery	<input checked="" type="checkbox"/> Vertical Group	11/12/2013
	<input checked="" type="checkbox"/> Horizontal Committee	18/06/2014
Question related to: Directive 2006/42/EC Article: 2.2.2 Annex: I and IV	EN/prEN: EN 15895	Other: EN16264
	Clause: 6.5	Other clause: ISO12100
GEN TC concerned: TC 213 WG 2		
Key words: Bolt setting devices, Cattle stunners, other hand held cartridge operated fixing and impact machinery		
Question: What kind of devices have to be treated under the Machine Directive Annex IV, No.18.		
Solution: Cartridge operated portable fixing and other impact machinery must be designed and constructed in such a way that energy is transmitted to the impacted element by the intermediary component that does not leave the device:		
Classification of all known technical cartridge operated devices:		
Cartridge Actuated Devices :		
	a) covered by Annex IV of MD	b) considered as fire arms not in scope of MD
Bolt Setting Device (<i>indirect piston driven</i>)	X	
Bolt Shooting Device (<i>direct cartridge driven</i>)		X
Hard Marking Devices	X	
Cattle Stunning Devices	X*	
Cord Launching Devices		X
Cable Shooting Devices		X
Industrially Used Cannons		X
Self-Shooting Vole Trapping Devices		X
Seismological Test Explosion Devices		X
Cutting and Separating with Counter Bearings	X	
Water Shooting Devices and Disruptors		X
Launcher for Retriever Dog Training		X
		
a) Indirect actuating principle according to M.D.	b) direct actuating principle	
*See Guide to Application of the Machinery Directive 2006/42/EC, Print Version: June 2010, 2. Edition, para. 280		

(1) Essential safety requirement

Note: According to point 6.6 of the Guide of the implementation of directives based on the New Approach and the Global Approach, the notified bodies apply as general guidance this recommendation for use.