



European
Commission

JRC TECHNICAL REPORTS

Assessment of the Methodology for Establishing the EU List of Critical Raw Materials

Background Report

Blengini, G.A., Blagoeva, D., Dewulf, J.,
Torres de Matos, C., Nita, V., Vidal-Legaz, B.,
Latunussa, C.E.L., Kayam, Y., Talens Peirò, L.,
Baranzelli, C., Manfredi, S., Mancini, L.,
Nuss, P., Marmier, A., Alves-Dias, P.,
Pavel, C., Tzimas, E., Mathieux, F.,
Pennington, D. and Ciupagea, C.

2017

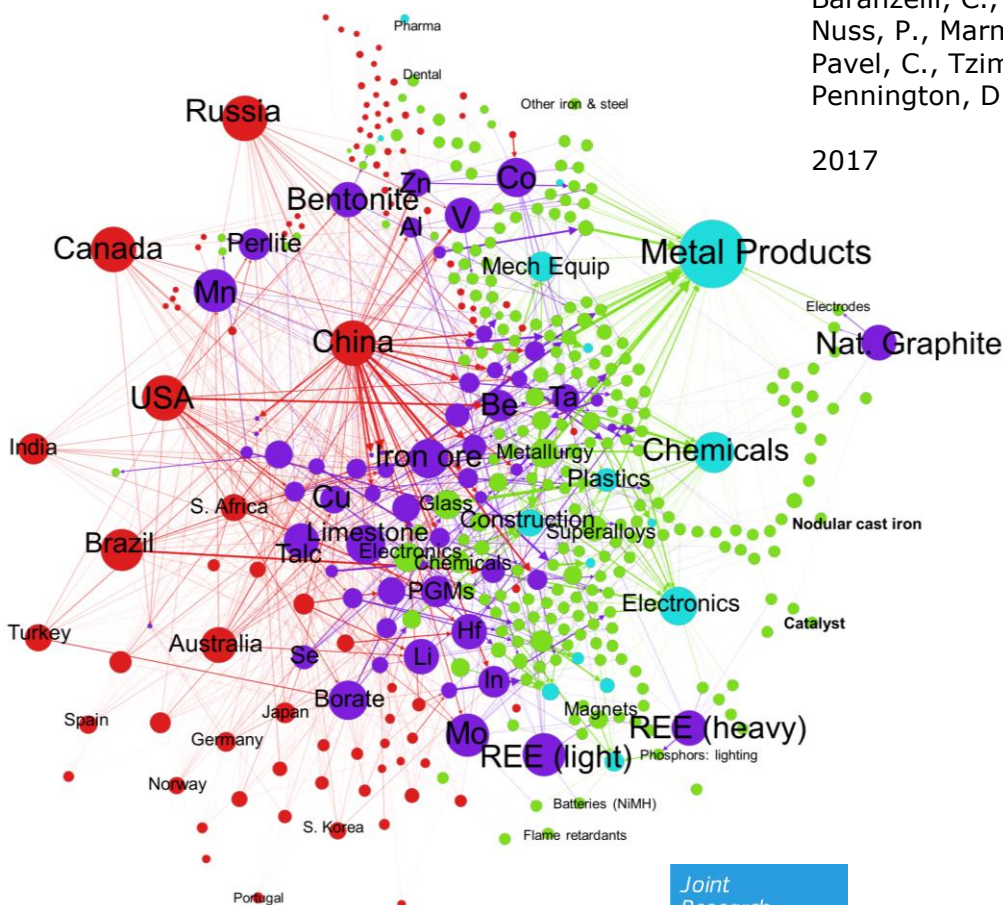

This publication is a Technical report by the Joint Research Centre (JRC), the European Commission's science and knowledge service. It aims to provide evidence-based scientific support to the European policymaking process. The scientific output expressed does not imply a policy position of the European Commission. Neither the European Commission nor any person acting on behalf of the Commission is responsible for the use that might be made of this publication.

This report has been developed in the context of the contract SI2.702038 between DG GROW and DG JRC. Project coordination: Mattia Pellegrini (Head of Unit), Alexis Van Maercke, Milan Grohol, Lidia Godlewska and Slavko Solar (Directorate-General for Internal Market, Industry, Entrepreneurship and SMEs – DG GROW).

JRC Science Hub

<https://ec.europa.eu/jrc>

JRC106997

EUR 28654 EN

Print	ISBN 978-92-79-69611-4	ISSN 1018-5593	doi:10.2760/130462
PDF	ISBN 978-92-79-69612-1	ISSN 1831-9424	doi:10.2760/73303

Luxembourg: Publications Office of the European Union, 2017

© European Union, 2017

Reuse is authorised provided the source is acknowledged. The reuse policy of European Commission documents is regulated by Decision 2011/833/EU (OJ L 330, 14.12.2011, p. 39).

For any use or reproduction of photos or other material that is not under the EU copyright, permission must be sought directly from the copyright holders.

How to cite this report: Blengini, G.A., Blagoeva, D., Dewulf, J., Torres de Matos, C., Nita, V., Vidal-Legaz, B., Latunussa, C.E.L., Kayam, Y., Talens Peirò, L., Baranzelli, C., Manfredi, S., Mancini, L., Nuss, P., Marmier, A., Alves-Dias, P., Pavel, C., Tzimas, E., Mathieux, F., Pennington, D. and Ciupagea, C. *Assessment of the Methodology for Establishing the EU List of Critical Raw Materials*, Publications Office of the European Union, Luxembourg, 2017, 978-92-79-69611-4, doi:10.2760/130462, JRC106997

All images © European Union 2017, [cover page] 'Network visualisation of the EU criticality dataset showing countries, materials, product applications, and sectors', Philip Nuss, 2016

Printed in 2017 (Italy)

Table of Contents

1	EXECUTIVE SUMMARY.....	1
1.1	Overall Framework and Scope.....	1
1.2	Criticality vs resilience	1
1.3	Revised EU Criticality Methodology	3
1.3.1	Economic Importance.....	3
1.3.2	Supply Risk.....	3
1.4	Structure of this Report.....	4
2	ECONOMIC IMPORTANCE.....	5
2.1	Summary	5
2.2	Calculation of economic importance	6
2.2.1	Importance of raw materials for sectors in previous criticality studies	6
2.2.2	Importance of raw materials for sectors: proposed adjustments.....	9
2.3	Substitution Index.....	12
2.3.1	Summary	12
2.3.2	Substitutability / substitution concept in the literature	12
2.3.3	Substitution approach in the revised methodology	12
2.3.4	Substitution Index (SI) calculation.....	13
2.3.5	Substitution calculation within EI component (SI_{EI})	15
2.3.6	Substitution within SR component (SI_{SR})	17
	Substitute Production (SP) assessment	18
	Substitute Criticality (SCr) assessment	18
	Substitute Co- production (SCo) assessment	19
3	SUPPLY RISK	21
3.1	Summary	21
3.2	Import Dependency and Supply chain Approach.....	21
3.2.1	Summary	21
3.2.2	Import dependency and its use in connection with Global suppliers mix, Actual sourcing and Supply chain approach	22
3.3	World Governance Index and Alternative Approaches	25
3.3.1	Summary	25
3.3.2	WGI in previous criticality studies	25
3.3.3	WGI Analysis	26
	WGI: methodology and data sources	26
	WGI dimensions: scope and correlation analysis	28
	WGI dimensions and the scope of the study	28
	Correlation between WGI dimensions.....	29
3.3.4	Alternative approaches to WGI	29
	Extractive Industries Transparency Initiative (EITI)	30
	Revenue Watch Institute's Resource Governance Index (RGI).....	33
	Policy Perception Index (PPI)	36
3.3.5	The use of WGI in the revised methodology	41

3.4	Trade.....	44
3.4.1	Summary	44
3.4.2	Export restrictions	44
3.4.3	International trade agreements	47
3.4.4	Construction and use of the trade-related variable	48
3.5	Secondary raw material and recycling	52
3.5.1	Summary	52
3.5.2	Introduction	52
3.5.3	Secondary raw materials, recycling and recyclability	53
3.5.4	Role of recycling in previous criticality studies	55
3.5.5	Secondary raw materials and recycling in the revised methodology	55
3.5.6	Outlook	64
3.6	Substitution in SR	66
4	BIOTIC MATERIALS.....	67
4.1	Summary	67
4.1.1	Biotic raw materials in the criticality assessment	67
4.1.2	Why are biotic raw materials important?.....	68
4.1.3	Why are biotic raw materials different from abiotic?	69
4.2	Assessment of the suitability of the refined methodology for biotic materials.....	69
4.2.1	Natural rubber: background information	70
4.2.2	Cork: background information	73
4.2.3	Step by step discussion on the suitability of the refined methodology for biotic materials.....	74
4.3	Confirmations / novelties in the revised methodology (biotics)	80
5	ADDITIONAL INFLUENCES	81
5.1	Summary	81
5.2	Land use competition.....	82
5.2.1	Summary	82
5.2.2	Background	82
5.2.3	Analysis.....	83
5.2.4	Concluding remarks on land use competition	98
5.3	Mining governance	100
5.3.1	Summary	100
5.4	Sustainable sourcing of biotic materials.....	101
5.4.1	Summary	101
5.4.2	Introduction	101
5.4.3	Analysis.....	101
5.4.4	Concluding remarks on sustainable sourcing of biotics.....	104
5.5	Supply chain approach	105
5.5.1	Summary	105
5.5.2	Introduction	105
5.5.3	Analysis.....	105
5.5.4	Concluding remarks on supply chain approach	107
5.6	By-production dynamics	108

5.6.1	Summary	108
5.6.2	Introduction	108
5.6.3	Analysis.....	109
5.6.4	Concluding remarks on by-production	109
5.7	End use competition	111
5.7.1	Summary	111
5.7.2	Analysis.....	111
5.7.3	Concluding remarks on end-use competition	112
5.8	Environmental and social considerations	113
5.8.1	Summary	113
5.8.2	Introduction	113
5.8.3	Analysis.....	114
5.8.4	Concluding remarks on environmental / social issues	117
5.9	Natural disasters, fires, pests and diseases.....	119
5.9.1	Summary	119
5.9.2	Analyses.....	119
5.9.3	Concluding remarks on natural disasters, etc.	122
6	ANALYSIS OF DATA AVAILABILITY AND QUALITY	123
6.1	Summary	123
6.2	Data needs for the updated methodology	123
6.3	Data identification	124
6.4	Data description.....	124
6.5	Navigating through the data file	125
6.6	Data availability overview.....	126
6.7	Proposals for datasets to be used	128
6.8	Data gaps	129
6.9	Quality assessment of the data sources	129
7	THE USE OF THE LIST OF CRMS	131
7.1	Summary	131
7.2	Survey respondents.....	131
7.3	Survey results	132
7.4	General observations from the survey.....	144
7.5	Literature review: assessment of national and other criticality assessments.....	145
7.6	Conclusions	149
8	REFERENCES	152

1 EXECUTIVE SUMMARY

1.1 Overall Framework and Scope

This report presents the results of work carried out by the Directorate General (DG) Joint Research Centre (JRC) of the European Commission (EC), in close cooperation with Directorate-General for Internal Market, Industry, Entrepreneurship and SMEs (GROW), in the context of the revision of the EC methodology that was used to identify the list of critical raw materials (CRMs) for the EU in 2011 and 2014 (EC 2011, 2014). As a background report, it complements the corresponding Guidelines Document, which contains the “ready-to-apply” methodology for updating the list of CRMs in 2017. This background report highlights the needs for updating the EC criticality methodology, the analysis and the proposals for improvement with related examples, discussion and justifications. However, a few initial remarks are necessary to clarify the context, the objectives of the revision and the approach.

As the in-house scientific service of the EC, DG JRC was asked to provide scientific advice to DG GROW in order to assess the current methodology, identify aspects that have to be adapted to better address the needs and expectations of the list of CRMs and ultimately propose an improved and integrated methodology. This work was conducted closely in consultation with the adhoc working group on CRMs, who participated in regular discussions and provided informed expert feedback. The analysis and subsequent revision started from the assumption that the methodology used for the 2011 and 2014 CRMs lists proved to be reliable and robust and, therefore, the JRC mandate was focused on fine-tuning and/or targeted incremental methodological improvements. An in depth re-discussion of fundamentals of criticality assessment and/or major changes to the EC methodology were not within the scope of this work.

High priority was given to ensure good comparability with the criticality exercises of 2011 and 2014. The existing methodology was therefore retained, except for specific aspects for which there were policy and/or stakeholder needs on the one hand, or strong scientific reasons for refinement of the methodology on the other. This was partially facilitated through intensive dialogue with DG GROW, the CRM adhoc working group, other key EU and extra-EU stakeholders.

The following considerations summarise the framework and scope of the analyses presented in this report and the subsequent revision of the methodology summarised in the Guidelines:

- Ensure the **highest possible level of comparability** with the 2011 and 2014 lists
- Intense and active **dialogue with stakeholders** since an early-stage in the revision
- **Non-forward looking approach** in the assessment, i.e. criticality is seen as a “snapshot in time” of the current (or past) raw materials situation
- Use of **best quality data** reflecting the average of data for the last **5 years**

1.2 Criticality vs resilience

In the revised EC criticality methodology discussed in this report a clear separation is drawn between backward-looking and forward-looking approaches. In terms of scope, all the parameters in the criticality equations therefore focus on the current situation, which in turn reflects the recent past (average of the latest 5 years, when available). Accordingly, considerations and/or solutions that might change the picture, but that are not readily-available today, are not taken into account in this criticality assessment.

The revised EC criticality assessment methodology can therefore be considered a **snapshot** of the current situation, based on the recent past. Potential further analysis of future-orientated options, or forecasts, is not integrated. The sharp distinction between backward-looking and forward-looking approaches can also be presented in terms of separation between **Criticality** and **Resilience** (Figure 1); where resilience is related to the future response of the systems in the context of inadequate supply of a given material.

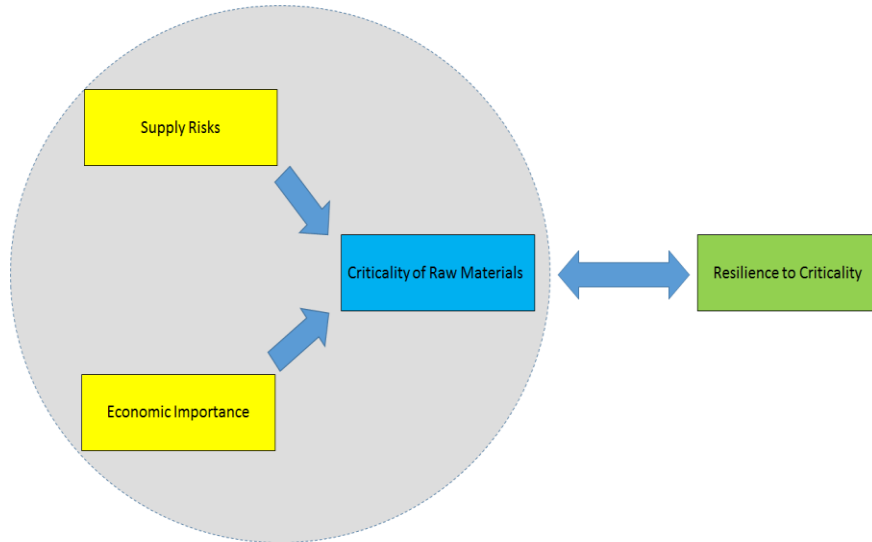

Figure 1 Resilience as concept to deal with criticality and supply disruptions.

Critical Raw Materials are both of high economic importance for the EU and vulnerable to supply disruption¹. **Vulnerable to supply disruption** means that the supply is associated to a high risk of not being adequate to meet EU industry demand. **High economic importance** means that the raw material is of fundamental importance to industry sectors that create added value and jobs, which could be lost in case of inadequate supply and if adequate substitutes cannot be found.

Resilience can be defined as the capacity of a system to tolerate disruptions while retaining its structure and function (Sprecher et al. 2015). In case of criticality of raw materials, it reflects how well the system is able to deal with inadequate supply. Resistance, rapidity and flexibility are considered as the cornerstones of resilience.

Bearing the above concepts in mind, in the revised EC methodology, criticality is seen as an analysis of the current situation, whereas resilience is related to the response of the systems. In other words, criticality is the assessment, based on a backward-looking approach, whereas resilience refers to the responses and policy recommendations related to the future.

This background report and the underlying revised methodology, summarised in the Guidelines, are focused on criticality assessment, whereas resilience is considered out of scope for the revision of the list, but of high relevance in the context of the raw materials policy. In the report, the separation between criticality and resilience is highlighted in several parts to underline the differences in the revised methodology and set the scene for future research and/or policy recommendations in the domain of resilience.

¹ **COM(2015) 614 final**: Closing the loop - An EU action plan for the Circular Economy

1.3 Revised EU Criticality Methodology

1.3.1 Economic Importance

The importance of a raw material to the economy of the Union is assessed by the indicator “Economic Importance (EI)”. This indicator relates to the potential consequences in the event of an inadequate supply of the raw material.

In previous criticality assessments (EC 2011, 2014), EI was evaluated by accounting for the fraction of each material associated with megasectors at EU level and their gross value added (GVA). However, megasectors combine several 3- and 4-digit NACE² sectors and therefore represent GVA at a high level of aggregation. In order to link raw materials to the corresponding manufacturing sectors at higher levels of sectoral resolution, section 2.2 examines the classification of product groups, economic activities, and NACE sectors in which raw material are used. The resultant revised approach allows for a more detailed allocation of raw material uses to the corresponding NACE sectors.

In addition, previous criticality assessments (EC 2011, 2014) accounted for substitution in the supply risk (SR) component. Nevertheless, the ability to substitute the candidate material with a currently available alternative material has the potential to also change the overall consequences to the EU economy in case of a supply disturbance. Section 2.3 discusses whether and to what extent substitution of raw materials can be integrated in the EI component and provides an outline of different parameters of substitution.

The revised approach to calculate EI results in the following calculation procedure:

$$EI = \sum_s (A_s * Q_s) * SI_{EI}$$

In the formula, EI is economic importance; A_s is share of end use of a raw material in a NACE Rev. 2 2-digit level sector; Q_s is NACE Rev. 2 2-digit level sector’s VA; SI_{EI} is substitution index (SI) of a RM (in economic importance); and s denotes sector.

The **two main novelties** of the refined EI component include: (1) A more detailed and precise allocation of RM uses to their corresponding NACE sectors, and (2) Use of a RM-specific substitution index in the calculation of EI to allow for a reduction in the potential consequences to the European economy due to inadequate supply.

1.3.2 Supply Risk

The risk of inadequate supply of a raw material to meet industry demand is assessed using the indicator “supply risk (SR)”.

The SR indicator in the EU criticality assessment (EC 2011, 2014) is based on the concentration of primary supply from countries and their governance. Secondary production of raw materials (recycling) and Substitution are considered to reduce SR.

In the revised methodology the JRC examined the parameters used in the SR calculation and explored potential improvements and future directions to widen the scope of the criticality assessment. An assessment of the World Governance Indicator (WGI) and other country-level indicators suggested that WGI is the most robust indicator to capture the level of governance in a country in the context of the criticality assessment. Moreover, WGI is applicable to different life-cycle stages of a material (e.g., mining and refining). Other indicators may focus only on a single life-cycle stage (e.g., mining) or a specific type of material (e.g., metals and metalloids). However, WGI does not capture risks due to export restrictions (e.g., export quotas with regard to certain materials) or

²Nomenclature statistique des activités économiques dans la Communauté européenne (NACE).

the mitigating effects of risk as a result of international trade agreements. Therefore, in the revised methodology WGI is adjusted by an additional trade-related variable. Equally, the influence of recycling on SR was further discussed and related data sources and calculation procedures reviewed. JRC recommended (1) to use European-centric material flow data, whenever possible, in order to better capture the EU situation of secondary raw materials, and (2) to calculate end-of life recycling input rates (EOL-RIR) uniformly across all candidate materials to allow for comparison with other data sources (e.g., UNEP). In addition, the role of the substitution in the final criticality assessment was re-examined. In the previous methodology, the substitution index based on expert judgement was serving as a filter to reduce the supply risk. In the revised methodology, the substitution is introduced into both components: economic importance and supply risk and quantitative way of estimating the substitution potential is proposed.

The **revised approach** incorporates **novel methodological elements** for trade, import dependency and the actual supply mix to the EU (i.e. the actual sourcing, which is the mix of domestic production plus imports), in parallel to **substantial improvements** for substitution and recycling as risk reducing measures, resulting in the following equation:

$$SR = \left[(HHI_{WGI,t})_{GS} \cdot \frac{IR}{2} + (HHI_{WGI,t})_{EU_{sourcing}} \left(1 - \frac{IR}{2} \right) \right] \cdot (1 - EOL_{RIR}) \cdot SI_{SR}$$

In this formula, SR stands for supply risk; HHI is the Herfindahl Hirschman Index (used as a proxy for country concentration); WGI is the scaled World Governance Index (used as a proxy for country governance); t is the trade adjustment (of WGI); IR stands for Import Reliance; GS is for global supply; EU_{sourcing} is for the actual suppliers; EOL_{RIR} is the End-of-Life Recycling Input Rate; and SI_{SR} = Substitution Index (in supply risk).

1.4 Structure of this Report

Chapter 2 of the report discusses the revised economic importance component. This is followed by chapter 3 presenting the supply risk component including the proposed modifications and expansion. The subsequent chapters focus on biotic materials (chapter 4), additional influences (chapter 5), an analysis of data availability and quality (chapter 6), and a detailed literature review and survey describing the users of the criticality assessment (chapter 7). Annexes³ provide further details and calculation examples.

Throughout the report, key definitions, examples, changes to the EU criticality methodology, and conclusions and findings are highlighted using **coloured text boxes**:

	Yellow boxes (single line) to underline definitions or key methodological aspects . (See examples above on definitions of criticality and resilience)
	Green boxes (single line) for examples . They <u>may be skipped by the reader</u> .
	Orange boxes highlight outcomes. Double and thick line is for changes or confirmations of the EU criticality methodology (Reflected in the equations).
	Single line means no changes , but specific requests for the fact sheets .
	Dashed line highlights future research and discussion topics.

³ JRC Technical Report 2017, Assessment of the Methodology for establishing the EU List of Critical Raw Materials - Annexes. Available at <https://ec.europa.eu/jrc>

2 ECONOMIC IMPORTANCE

2.1 Summary

The Economic Importance (EI) is an indicator of importance of the raw materials for the EU economy. It uses existing data and does not contain predictions or extrapolations.

The two main novelties of the refined EI component include: (1) A more detailed and precise allocation of RM uses to their corresponding NACE sectors, and (2) introduction of a dedicated substitution index SI_{EI} deemed to be a reduction factor for the EI (see section 2.3 for a detailed discussion of the substitution calculation).

In previous criticality assessments (EC 2011, 2014), EI was evaluated by accounting for the fraction of each material associated with industrial megasectors at EU level and their gross value added (GVA). However, megasectors combine several 3- and 4-digit NACE⁴ sectors with each other and therefore represent GVA at a high level of aggregation. In order to link raw materials to the corresponding manufacturing sectors at higher levels of sectoral resolution, section 2.2 examines the classification of product groups, economic activities, and NACE sectors in which raw material are generally used. The subsequent approach allows for a more detailed allocation of raw material uses to the corresponding NACE sectors.

In addition, previous criticality assessments (EC 2011, 2014) accounted for substitution in the supply risk (SR) component. Nevertheless, the ability to substitute the candidate material with a currently available alternative material, with similar technical and economic performance, is deemed to be a reduction factor for the overall consequences to the EU economy, i.e. a reduction of the economic importance.

The revised approach to calculate EI and material substitution results in the following calculation procedure:

$$EI = \sum_s (A_s * Q_s) * SI_{EI}$$

In this formula, EI is economic importance; A_s is the share of end use of a raw material in a NACE Rev. 2 2-digit level sector; Q_s is the NACE Rev. 2 2-digit level sector's VA; SI_{EI} is the substitution index (SI) of a RM (to be used in economic importance); and s denotes sector.

⁴Nomenclature statistique des activités économiques dans la Communauté européenne (NACE), which is the statistical classification system of economic activities in the European community.

2.2 Calculation of economic importance

The following two sections present the main features of the method of calculating the economic importance of raw materials (RM) used in previous criticality assessments (EC 2011, 2014). It is followed by the proposed methodological improvements.

2.2.1 Importance of raw materials for sectors in previous criticality studies

In the 2014 Report on critical raw materials (EC 2014), the economic importance of a RM was calculated in **five steps**, as follows:

- i. Identification of RM end-uses and their corresponding shares of net demand ("distribution of end uses");
- ii. Allocation of end uses to the "megasectors", defined as "a collection of related NACE sectors" at NACE 3- and 4-digit level;
- iii. Calculation of the GVA of megasectors based on Eurostat' Structural Business Statistics data for the EU27;
- iv. Multiplication of end use shares by megasectors' GVA;
- v. Scaling of the results.

The economic importance (before the scaling step) was calculated using the following formula:

$$EI = \sum_s (A_s * Q_s)$$

Where:

- A_s is the share of demand of a RM in a megasector (with $\sum A_s = 1$, since all RM's end uses are covered);
- Q_s is the megasector's GVA.

In a hypothetical example, following the worked example presented in Annex D of Chapman et al. (2013), economic importance (including scaling) of a certain RM was calculated as follows:

$$EI = \{[(GVA-A*0.4) + (GVA-A*0.2) + (GVA-C*0.15) + (GVA-D*0.25)] / GVA-C\} * 10$$

Where:

- EI is economic importance;
- $GVA-(A \text{ or } B \text{ or } C \text{ or } D)$ is the Gross Value Added of megasectors A, B, C, D and E, respectively;
- p_i is the share of net consumption of raw material i in a specific end use.

The hypothetical example is graphically represented in Figure 2.

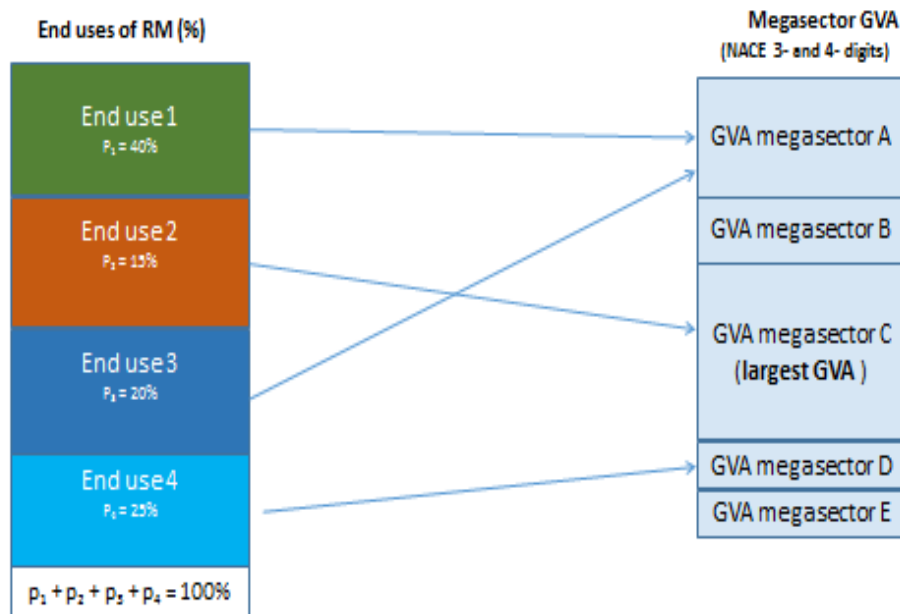

Figure 2 A hypothetical example of the economic importance (EI) calculation in previous criticality reports (EC 2011, 2014).

The JRC identified **two main areas of improvement**:

- 1) **Allocation of end uses to the industrial sectors.** Undetailed statistical linkages between megasectors and different compounding 3- or 4-digit NACE sectors lead to an unclear assignment of different RM end uses to the 3- or 4-digit NACE sectors (Table 1). As a consequence, a highly aggregated GVA (of the corresponding megasector) is used in the EI calculation instead of separate GVAs corresponding to the more disaggregated NACE sector GVAs.
- 2) **Linking end use shares with manufacturing sector value added.** Allocation of end uses to the “megasectors” was made taking an “as far down the value chain as possible” approach, which does not take into account the upstream uses of a RM in manufacturing sectors.

Table 1. *Examples of megasectors composition.*

Electrical Equipment + Domestic Appliances	DL311 - Manufacture of electric motors, generators and transformers	271 - Manufacture of electric motors, generators, transformers and electricity distribution and control apparatus
	DL312 - Manufacture of electricity distribution and control apparatus	272 - Manufacture of batteries and accumulators
	DL313 - Manufacture of insulated wire and cable	273 - Manufacture of wiring and wiring devices
	DL314 - Manufacture of accumulators, primary cells and primary batteries	274 - Manufacture of electric lighting equipment
	DL315 - Manufacture of lighting equipment and electric lamps	275 - Manufacture of domestic appliances
	DL316 - Manufacture of electrical equipment n.e.c.	279 - Manufacture of other electrical equipment
	DK297 - Manufacture of domestic appliances n.e.c.	3314 - Repair of electrical equipment
NACE Rev 1.1		NACE Rev 2
Road Transport	DM341 - Manufacture of motor vehicles	291 - Manufacture of motor vehicles
	DM342 - Manufacture of bodies (coachwork) for motor vehicles; manufacture of trailers and semi-trailers	292 - Manufacture of bodies (coachwork) for motor vehicles; manufacture of trailers and semi-trailers
	DM343 - Manufacture of parts and accessories for motor vehicles and their engines	293 - Manufacture of parts and accessories for motor vehicles
	DM354 - Manufacture of motorcycles and bicycles	309 - Manufacture of transport equipment n.e.c.
		3317 - Repair and maintenance of other transport equipment
NACE Rev 1.1		NACE Rev 2
Aircraft, Shipbuilding, Trains	DM351 - Building and repairing of ships and boats	301 - Building of ships and boats
	DM352 - Manufacture of railway and tramway locomotives and rolling stock	302 - Manufacture of railway locomotives and rolling stock
	DM353 - Manufacture of aircraft and spacecraft	303 - Manufacture of air and spacecraft and related machinery
		3315 - Repair and maintenance of ships and boats
		3316 - Repair and maintenance of aircraft and spacecraft
NACE Rev 1.1		NACE Rev 2
Other Final Consumer Goods	DN361 - Manufacture of furniture	310 - Manufacture of furniture
	DN362 - Manufacture of jewellery and related articles	321 - Manufacture of jewellery, bijouterie and related articles
	DN363 - Manufacture of musical instruments	322 - Manufacture of musical instruments
	DN364 - Manufacture of sports goods	323 - Manufacture of sports goods
	DN365 - Manufacture of games and toys	324 - Manufacture of games and toys
	DN366 - Miscellaneous manufacturing n.e.c.	257 - Manufacture of cutlery, tools and general hardware
	DJ286 - Manufacture of cutlery, tools and general hardware	264 - Manufacture of consumer electronics
		3291 - Manufacture of brooms and brushes
		3319 - Repair of other equipment
		9524 - Repair of furniture and home furnishings
	9529 - Repair of other personal and household goods	

Source: Annex C of the "Study on Critical Raw Materials at EU Level" ; Final Report (Chapman et al. 2013).

2.2.2 Importance of raw materials for sectors: proposed adjustments

The proposed adjustments to the EI component of the EU criticality methodology include (1) the refinement in the calculation of GVA related to raw materials use in the EU economy and (2) consideration of substitution as an approach to mitigate the consequences of a potential raw materials shortage to the EU economy. Both adjustments are further explained below.

Area of improvement 1: Allocation of end uses to the industrial sectors. Due to the multitude of RM industrial uses, in our proposed method we focused on RM *primary uses in the manufacturing sectors*.

Example: In the 2014 criticality assessment (EC 2014) the use of Lithium for “Batteries” was assigned to the megasector “Electronics”, while the improved methodology allocates the same end use to the manufacturing sector “Manufacture of electrical equipment (NACE Rev. 2 code 27)/ Manufacture of batteries and accumulators (NACE Rev.2 code 27.2)” (see the worked example of Lithium in the Annex).

For mapping and grouping the RM uses into NACE 2-, 3- or 4-digit sectors (disaggregation level to be established depending on data availability), we used Eurostat’s PRODCOM and Statistical classification of products by activity (CPA 2008 structure). Because the PRODCOM product categories and CPA classes are statistically linked to each other and to the NACE sectors, using them enables relating RM uses to the corresponding manufacturing sectors.

The allocation flow of RM uses is as follows. When possible, the PRODCOM product groups and the 5-/6-digit CPA classes corresponding to each type of RM uses need first to be identified. In the cases in which the identification of CPA category is not possible, the shares could be allocated directly to the corresponding 4-, 3- or 2-digit NACE sectors.

At NACE 2-digit level, statistical identification of RM uses turned out to be easier. Allocation of the identified end uses to the NACE 2-digit level sectors is facilitated by the Eurostat’s statistical correspondence between CPA, NACE 3-/4-digit and NACE 2-digit.

Area of improvement 2: Linking end use shares with manufacturing sectors’ Value added. In the revised methodology, megasectors are not used anymore. Instead, the RM uses were allocated directly to the NACE sectors and related to the NACE sectors’ VA. In terms of data, this choice was feasible as Eurostat’ Structural Business Statistics⁵ provide data for the indicator “Value added at factor cost” at NACE 2-digit level and partly for 3- and 4-digit level. Thus, we propose to calculate economic importance at NACE 2-digit level (or 3-/ 4-digit level; disaggregation level to be established depending on data availability).

The new method’s calculation flow

The **two main novelties** are: (1) more detailed allocation of raw materials’ uses to the corresponding NACE sectors; and (2) including substitution (previously only present in

⁵ <http://ec.europa.eu/eurostat/web/structural-business-statistics/data/database>

supply risk) also in the economic importance component. The **scope** of the analysis is the EU manufacturing industry and the **reference period** includes data of the last 5 years, e.g., 2010-2015 or latest available 5 years.

The resulting economic importance calculation formula is:

$$EI = \sum_s (A_s * Q_s) * SI_{EI}$$

Where:

- EI stands for economic importance;
- A_s is the share of a certain RM used in a NACE Rev. 2 2-digit level sector;
- Q_s is the Value Added of the 2-digit-level NACE Rev. 2 sector;
- SI_{EI} is the substitution index of a RM to be used in economic importance (defined in section 3.2);
- s denotes the corresponding NACE Rev. 2 sector.

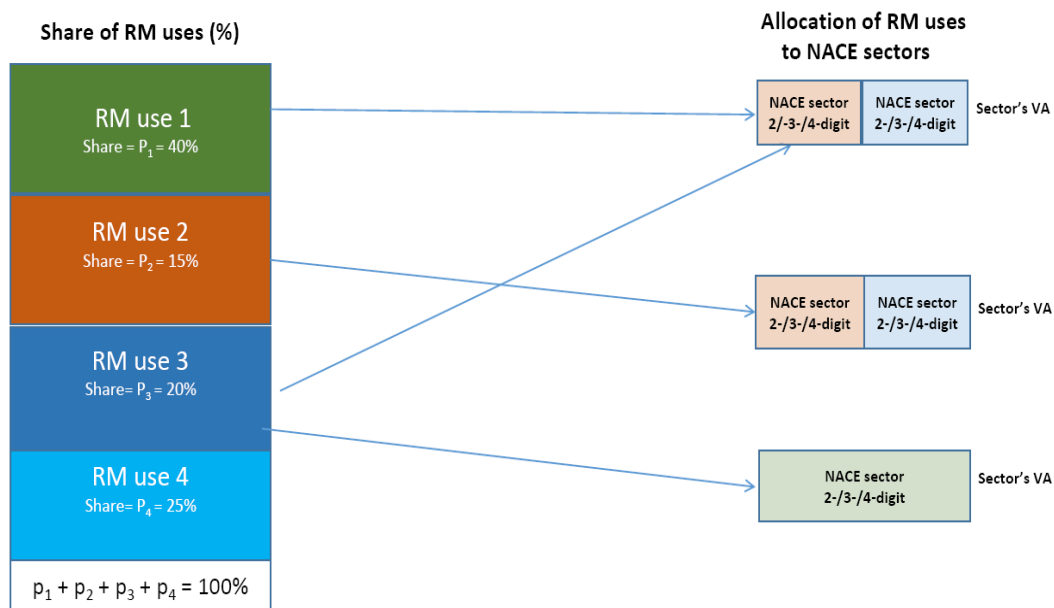

Figure 3: Visual representation of the revised methodology for the calculation of economic importance using a hypothetical example

The calculation flow of the new method follows **six steps**, as presented below.

The six-step method of calculating the economic importance in the revised methodology:

Step 1: Identification of RM end use applications in PRODCOM and 5-/6-digit CPA categories (where possible) and their corresponding shares;

Step 2: Allocation of each end use application to the corresponding manufacturing sector of a category C, defined by NACE Rev. 2 (2-digit level) classification provided by Eurostat. As a general approach, first the end uses at CPA level and/or NACE 3-/4-digit should be identified, and then they should be allocated to the corresponding sectors at NACE-2-digit level.

Step 3: Calculation of substitution index related to the economic importance component (SIEI) for the RM uses identified at Step 1;

Step 4: Compilation of sectorial value added (VA) data for the NACE Rev. 2 sectors at the 2-digit level. Most data is provided by Eurostat's Structural Business Statistics;

Step 5: Calculating the EI score by multiplication of RM end uses shares by industrial sectors' VA and by substitution indexes;

Step 6: Scaling the results by dividing the calculated EI score by the value of the largest manufacturing sector NACE Rev. 2 at the 2-digit level and multiplied by 10, in order to reach the value in the scale between 0-10.

The worked examples, i.e., both calculation flow and allocation of RM uses to the corresponding CPA classes and NACE sectors for lithium, indium, and tungsten are presented in the Annex.

2.3 Substitution Index

2.3.1 Summary

In the previous criticality assessments (EC 2011, 2014), substitution was only addressed as a filter or mitigation measure to decrease the supply risk (SR). Expert judgment was used to determine the substitution/substitutability indices used in the calculations. However, substitution can also alter the potential consequences of a supply shortage to the European economy and should therefore also be considered in the economic importance (EI) component. In this section, the substitution approach is reviewed both in the context of supply risk (SR) and economic importance (EI). A proposal is made to account for factors related to substitute production, criticality, and co-production in SR, and for the substitute performance and cost in the EI calculation of the criticality assessment. The proposed approach is illustrated with a few examples.

In the revised methodology, substitution is incorporated both in the EI and SR component. The supply risk related component of the substitutions (SI_{SR}) covers substitute availability in terms of production volumes (SP), substitute criticality (SCr), and substitute co-production (SCo). The economic importance related component (SI_{EI}) covers substitute cost-performance (SCP). The reasoning for including substitution in the EI component is its technical and economic performance of substitutes in specific applications affecting use on the market and readiness for the market uptake.

2.3.2 Substitutability / substitution concept in the literature

The 'Substitution' and 'Substitutability' is addressed in several studies, e.g., (BGS 2012; NRC 2008; AEA Technology 2010), General Electric (Duclos 2010; GE 2010), US Department of Energy (USDOE 2010, 2011), Volkswagen AG and the German Federal Institute for Geosciences and Natural Resources (BGR) (Rosenau-Tornow et al. 2009), Oakdene Hollins (Morley and Eatherley 2008), University of Augsburg (Achzet et al. 2011), in qualitative or semi-quantitative manner. Expert elicitation is indispensable for such qualitative estimations. A slightly more detailed approach is adopted in the Yale methodology (Graedel et al. 2012, 2015). An overview of the screened studies and short description of the Substitutability/Substitution concept is given in Annex.

2.3.3 Substitution approach in the revised methodology

In the revised methodology for criticality assessment, the availability of **substitutes** is considered as a reducing element in both the **economic importance (SI_{EI})** and the **supply risk (SI_{SR})** dimensions. The assessment only takes into account the **proven substitutes** that are **readily available today** and able to reduce the consequences of a disruption and/or influence the risk of a disruption. Commercial information and published patents are only used to identify proven substitute alternatives readily available and applicable at the market today. Neither "substitutability" nor "potential future substitution" is considered in this methodology.

2.3.4 Substitution Index (SI) calculation

Starting from the current situation (snapshot), a structured semi-analytical approach is used to estimate the substitution indexes (SI) to be included in the EI (SI_{EI}) and SR (SI_{SR}) components when assessing the criticality of a given material.

The following factors and influences are taken into account in the assessment:

- Technical performance (extent to which substitute can replace the functionality of a candidate raw material in an application, e.g. it is very unlikely that a tantalum capacitor would be substituted with an aluminium capacitor because a mobile phone would weigh 1kg)
- Cost performance (costs often drive decisions in business)
- Substitute production (availability of substitutes in sufficient quantities needs to be considered)
- Substitute criticality (substituting one critical material by another is unlikely to decrease the RM supply risk in a given application)
- Substitute by-/co-production (if the proposed substitute is mainly obtained as a by- or co-product, its supply is dependent on a demand for another raw material)

The components of SI_{EI} and SI_{SR} are estimated based on the following subcomponents:

Substitution calculation within EI component (SI_{EI}):

- Substitute Cost-Performance (SCP)

Substitution calculation within SR component (SI_{SR}):

- Substitute Production (SP)
- Substitute Criticality (SCr)
- Substitute Co-Production (SCo)

A common part for both SI_{EI} and SI_{SR} is to determine:

- the readily available substitutes on the market (snapshot in time)
- the extent by which these substitutes contribute to the final SI (or their shares)

Commercial information and published patents are used to identify only proven substitute alternatives readily available and applicable at the market today. Details for the three materials – Indium, Lithium and Tungsten – are given in the Annex.

Individual contribution of each available substitute in the final SI is done in two steps:

The calculation of the SI_{EI} and SI_{SR} components is done in three steps:

Step 1: identifying the end-use applications' shares of the candidate material; should be the same shares as used in the calculation of the EI.

Example how to search for available substitutes: The following key words can be used to do the first search: name of the materials to be substituted + end-use application + substitution / alternatives / replacement. Further, more specific key words can be used for each application, e.g., if the material to be substituted is used as a coating, the name 'coating' can be added to the search. Attempts to add provisionally name of materials with similar chemical and physical properties may also lead to finding the possible substitutes. If no information can be found on the internet, the same combination of key words can be used in the freely available patents databases, such as Espacenet, EPO, OECD patent databases, etc.

Step 2: determining the 'sub-shares' of the substitute materials within each end-use application. In case information on the sub-shares is known or can be deduced from the commercial sources, the exact sub-shares are used in the calculations.

Example 1 on sub-share determination in the case of known information: Information is available for the batteries end-use application where Aluminium, Nickel, Zinc, Lead, and Sodium can substitute for Lithium (Source: SignumBox 2015).

Example 2 on sub-share determination in the case of known information: It is known that 4% of Tungsten is used for incandescent lamps. Wires product belongs to the 'mill products' end-use application of Tungsten with a share of 14%. Therefore, the substitute materials for tungsten wires used in incandescent lamps, namely Germanium, Silicon, Gallium, Indium, Europium, Terbium, and Yttrium (LED technology as a substitution possibility), are each participating with a very marginal share of $\approx 0.3\%$ in the final calculations. This is also an example of a product/technology for product/technology substitution.

Example 3 on sub-share determination in the case of known information: Indium can be substituted with Tin (Fluorine doped Tin Oxide - FTO) or Zinc (Aluminium doped Zinc Oxide - AZO) in flat panel displays application. However, this is scarcely done due to reduced performance of the displays. Therefore, it is assumed that only 10% of the produced displays are using Tin or Zinc and 90% still employ Indium, i.e. practically non substituted in this end-use application.

If the sub-shares of the different substitutes within one end-use application are not known, it is conservatively assumed that the candidate material is still used (not substituted) in 50% of the cases; the other 50% is divided equally between the existing substitutes.

Example 4 on sub-share determination in the case no information is available: Titanium, Silicon, Zirconium and Aluminium are viable substitutes of tungsten in hardmetals (cemented carbides) application with 60% share of Tungsten usage. In the calculations, 12.5% is assumed for each of the substitutes (50% divided equally by 4 substitutes) and 50% for Tungsten within the hardmetals application. The final contributions of the different substitute materials will thus be as following: Titanium (7.5%), Silicon (7.5%), Zirconium (7.5%), Aluminium (7.5%) and Tungsten (30%).

Example 5 on sub-share determination in the case no information (or vague information) is available: it is assumed that half of the 8% of Indium used in solar components is not substitutable, i.e. $50\% \cdot 8\% = 4\%$. The other half of the 8% Indium is substitutable by Silicon and Zinc both of the contributing with 2% to the final SI.

Step 3: Calculating the substitution sub-components: Substitute Cost-Performance (SCP), Substitute Production (SP), Substitute Criticality (SCr), Substitute Co-Production (SCo) and calculating the components of SI_{EI} and SI_{SR} as defined in the respective sections.

Approach to substitution in the revised methodology:

Substitution is dependent on several factors (as summarised below) and interferes essentially both with economic importance and supply risk:

1. Knowledge of existing substitutes (only readily-available substitutes)
2. Technical performance (e.g., very unlikely a tantalum capacitor would be substituted with an aluminium capacitor because a mobile phone would weight 1kg)
3. Cost performance (cost usually drives decisions in business)
4. Substitute production (whether the proposed substitutes are currently produced in sufficient quantities to be available for newly introduced end-uses)
5. Substitute criticality (whether the proposed substitute already a CRM in the 2014 list)
6. Substitute by-production (whether the proposed substitute mainly obtained as a by- or co-product, which can pose risk on its availability).

In the revised methodology elements influencing substitution are subdivided as follows:

- Substitution calculation within EI component (SI_{EI}):

Substitute Cost-Performance (SCP)

- Substitution calculation within SR component (SI_{SR}):

Substitute Production (SP)

Substitute Criticality (SCr)

Substitute Co-Production (SCo)

2.3.5 Substitution calculation within EI component (SI_{EI})

The following elements are used for the calculation of the Substitution index to be used in the EI dimension (SI_{EI}).

- Substitute material performance - in terms of technical performance and functionality.
- Substitute material cost - in terms of cost comparison between substitute and candidate material.

Rationale: The market decision to adopt a substitute material is taken on the basis of its cost and the technical performance/ functionality it offers.

Substitute Cost Performance (SCP)

The substitute performance and substitute cost are incorporated in one single parameter called Substitute Cost Performance (SCP).

The cost and performance elements are used for estimating the SCP sub-component using an evaluation matrix (Table 2):

- **Substitute material technical performance** and functionality in comparison to that of the candidate material within given application;
- **Substitute material cost** in comparison to the cost of the candidate material within given application.

Table 2 **Substitute Cost Performance (SCP)** evaluation matrix (based on current costs)

<i>Substitute material technical performance</i>	<i>Similar performance</i>	<i>Reduced performance</i>	<i>Performance in case of no substitute</i>
<i>Substitute material cost</i>			
<i>Very high costs (more than 2 times)</i>	0.9	1	1
<i>Slightly higher costs (up to 2 times)</i>	0.8	0.9	1
<i>Similar or lower costs</i>	0.7	0.8	1

This matrix is to be applied for each substitute material within given application. Maximum 30% reduction of the Economic Importance (EI) is assumed if all substitute materials offer similar performance at similar cost, which would be the ideal case – very unlikely to happen though. If all substitute materials offer reduced performance at very high cost (more than 2 times) it is unlikely that they would be adopted by the market even though available.

Further, the addition of the SCP parameters assigned to each substitute material multiplied by the sub-share of each substitute within particular end-use application, and in turn to the share of the candidate material in the end-use application, is used to determine the SI_{EI} for a given candidate material:

$$SI_{EI} = \sum_i \sum_a SCP_{i,a} * Sub - share_{i,a} * Share_a$$

Where:

- *i* denotes an individual substitute material
- *a* denotes an individual application of the candidate material
- SCP_i = Substitute Cost Performance parameter
- *Share* = the share of the candidate material in an end-use application
- *Sub-share* = the sub-share of each substitute within given application

Therefore, in this case no reduction of the EI is anticipated.

Example of determining the **Final Share of Titanium**, being substitute of **Tungsten** in cemented carbides end-use application:

Share = 60% (60% of Tungsten is used in hard metals application)

Sub-share = 12.5% (12.5% of the tungsten carbides are substituted with Titanium carbides)

Final Share = 60%*12.5% = 7.5%

The SCP values for the various substitutes are given in the Annex for the three studied materials.

Justification for including current substitution in economic importance:

The **principal justification** is the need to improve the current methodology in respect to its capacity of truly capturing the economic importance of raw materials. The current assessment is in fact targeted to measure the economic importance downstream the value chain. This approach is indeed very effective to raise awareness on the capacity of raw materials to generate added value and jobs in manufacturing, or further downstream, which is way beyond the market value of commodities. Unfortunately, in some cases the current methodology shows results that are considered an overestimation of the true economic importance by experts (e.g. experts argue that Vanadium cannot be more economically important than Iron, as Vanadium is mainly used for special steels, where it can often be substituted by other metals with only minor impacts). A correction is therefore necessary, i.e. incorporating substitution in economic importance, but taking into account readily-available substitutes only.

A **second justification** for incorporating substitution in economic importance is that substitution depends on end-use applications, therefore it is estimated in respect to the particular end-use application, which is also the starting point to estimate the economic importance in the EC methodology. It seems therefore more straightforward that substitution indexes are used in the same context where they are estimated, i.e. in economic importance. In the revised methodology it is recommended to estimate (and use) current substitution at the same disaggregation level that is used for the estimation of economic importance.

A **third justification** is the need not to overemphasise the role of substitution as a mitigation strategy. Substitution is in fact the only mitigation strategy that end-users (i.e. manufacturing) can deploy in case of a supply disruption, whereas in the context of the raw material policy (likely in resilience, not in criticality), a wider range of counter measures, including mining, recycling and substitution should be considered in a balanced manner, to set a more comprehensive and effective mitigation strategy. In addition, many experts currently argue that overemphasising the role of substitution (alone) can negatively impact innovation and new uses of "newly" exploited raw materials for which the potential of mining and recycling have not yet been explored to a large extent.

2.3.6 Substitution within SR component (SI_{SR})

As presented in the EI section of the report (section 2), substitution is dependent on factors such as the cost and technical performance of the substitute. Because existence of available substitutes has the potential to decrease the demand for the candidate material, it can also alleviate supply risk (SR) inherent in the current supply mix of the candidate material and is therefore included in the supply risk calculation. Considerations related to reducing the risk of supply disruptions in the short-term (through readily available substitutes), is important to business within the EU.

It is considered that physical availability of a substitute in the required quantities is an important factor in decreasing the SR. If a substitute material is already critical and highly demanded by other technologies and sectors, it may not be able to reduce risk of supply of the candidate material. The substitute's SR can also be influenced by the way how it is produced, as a main product or a by-/co-product depending on other products.

Substitute Production (SP) assessment

The Substitute Production (SP) parameter reflects the market size (global production data) of the candidate material compared to that of the substitute material. In this methodology, only substitutes that are available in sufficient quantities in terms of annual production are considered a potential reducing factor for the supply risk of the candidate material. While substitutes produced in lower quantities will not affect the SR. If a material with high annual production of e.g. hundred thousands of tonnes has to be substituted by a material with limited annual production (e.g. hundreds of tonnes) then it is very unlikely that substitution will take place, at least not on a large scale, due to the physical scarcity of the substitute material.

Therefore, the following approach is adopted for the SP:

- **SP = 0.8** if the annual global production of the substitute material is higher than that of the candidate material
- **SP = 1** if the annual global production of the substitute material is similar or lower than that of the candidate material

In other words, only substitutes that are available (in terms of global annual production) to replace the candidate material can contribute to SR reduction. Substitutes produced in quantities not sufficient to substitute for the candidate material will not be able to alleviate its SR.

Substitute Criticality (SCr) assessment

It is important to assess the criticality of the substitute itself. If a substitute material is already critical, it might not be readily available as a substitute option.

SCr is assigned for each substitute material according to the system below:

Substitute Criticality (SCr)	Rationale
SCr = 1	<i>If a substitute material was on the last EU list of CRM, this material is not expected to contribute to the reduction of the SR of the candidate material.</i>
SCr = 0.8	<i>If the substitute material was not critical in the last EU assessment or was not screened in the previous exercise, this material is expected to contribute to the reduction of the SR of the candidate material.</i>
SCr = 1	<i>If no substitute material is available, no reduction of the SR is assumed.</i>

To be noted that if the assessed substitute was not screened in the previous exercise, it is assumed that it is not critical, thus SCr = 0.8.

Substitute Co- production (SCo) assessment

Co-/By-production of the substitute materials is a new element that is considered in this methodology. For candidate materials, such as minor metals (REE, In, Ga, Ge etc.) it could be a significant constraint on the immediate supply of these materials. Co-production dynamics is considered also in the criticality methodologies of USA (US Critical Materials Institute) as one of the risk factors, as well as Japan (JOGMEC) in the supply risk component.

For the present methodology a simple approach is used to estimate the influence of the substitute co-production or by-production:

Substitute Co-production (SCo) scoring	Rationale
SCo = 1	<i>If the substitute material is mined only as by-product or co-product - no reduction of the SR of the candidate material is assumed</i>
SCo = 0.8	<i>If the substitute material is mined as primary material – up to 20% reduction of the SR is assumed</i>
SCo = 0.9	<i>If the substitute material is mined both as primary material, but also as by-/co-product (e.g. the case of Mo) - up to 10% reduction of the SR is assumed</i>
SCo = 1	<i>If no substitute material is available no reduction of the SR is assumed</i>

SR-specific Substitution Index (SI_{SR}) of a candidate material is therefore calculated as a geometric average of three parameters - Substitute Production (SP), Substitute Criticality (SCr) and Substitute Co-production (SCo) - assigned to each substitute material, multiplied by the sub-share of each substitute, and to the share of the end-use:

$$SI_{SR} = \sum_i [(SP_i * SCr_i * SCo_i)^{1/3} * \sum_a (Sub - share_{i,a} * Share_a)]$$

Where:

- *Substitute Production (SP) reflects (compares) global production of the substitute and the candidate material as an indicator of whether sufficient amounts of substitute material are available to be used if/when necessary;*
- *Substitute Criticality (SCr) takes into account whether the substitute was critical in the previous EU CRM list;*
- *Substitute Co-production (SCo) takes into account whether the substitute is a primary product or is produced as a co-/by-product; if obtained only as co-/by-product, its availability would be seriously questioned;*
- *i denotes an individual substitute material*
- *a denotes an individual application of the candidate material*

The SP, SCr and SCo parameters are to be determined for each substitute of the relevant candidate material.

Example: *If all substitute materials are main products, not-critical, and produced in sufficient quantities, the maximum expected reduction of the SR of the candidate materials is 20%.*

Revision of the current methodology:

In the revised methodology, substitution is **incorporated both in the EI and SR component.**

The reasoning for including substitution in the **EI component** (this section) is that a readily available substitute (considering cost and performance in the end-use application examined) can alter the consequences of a potential supply disruption to the EU economy. The market decision to adopt a substitute material is taken on the basis of its cost and the technical performance/ functionality it offers.

Because existence of available substitutes has the potential to decrease the demand for the candidate material, it can alleviate supply risk inherent in the current supply mix of the candidate material and is therefore also included in the **SR calculation** (section 3.6) considering issues of substitute availability, substitute criticality, and substitute co-production (companionality).

3 SUPPLY RISK

3.1 Summary

The supply risk (SR) component in the EU criticality assessment (EC 2011, 2014) accounts for concentration of primary supply from countries exhibiting poor governance. Secondary production of raw materials (recycling) and substitution are considered as parameters that can potentially reduce SR.

This section examines the parameters used in the SR calculation and explores potential improvements and future directions to widen the scope of the criticality assessment. Firstly, an assessment of the World Governance Indicator (WGI) and other country-level indicators is provided. We find that WGI is a robust indicator to capture the level of governance in a country and the indicator is applicable to different life-cycle stages of a material (e.g., mining and refining). In contrast, other indicators may focus only on a single life-cycle stage (e.g., mining) or a specific type of material (e.g., metals and metalloids). However, WGI does not capture risks due to export restrictions (e.g., export quotas with regard to certain materials) or the mitigating effects of risk as a result of international trade agreements. Therefore, we propose to adjust WGI by an additional trade-related variable to capture these influences. Finally, the influence of recycling on SR is discussed and related data sources and calculation procedures are reviewed. We propose (1) to use European-centric material flow data, whenever possible, in order to better capture the EU situation of secondary raw materials, and (2) calculate end-of life recycling input rates (EOL-RIR) uniformly across all candidate materials to allow comparison with estimates provided elsewhere (e.g., UNEP).

The revised approach to incorporate issues of trade, import dependency, the actual supply mix to the EU (i.e., the mix of domestic production plus imports, which is the actual sourcing of the supply to the EU) and substitution and recycling as risk reducing measures, results in the following calculation procedure:

$$SR = \left[(HHI_{WGI-t})_{GS} \cdot \frac{IR}{2} + (HHI_{WGI-t})_{EU_{sourcing}} \left(1 - \frac{IR}{2} \right) \right] \cdot (1 - EoLRIR) \cdot SI_{SR}$$

In this formula, SR stands for supply risk; HHI is the Herfindahl Hirschman Index (used as a proxy for country concentration); WGI is the scaled World Governance Index (used as a proxy for country governance); t is the trade adjustment (of WGI); IR stands for Import Reliance; GS is for global supply; EU_{sourcing} is for the actual suppliers; EOLRIR is the End-of-Life Recycling Input Rate; and SI_{SR} = Substitution Index (in supply risk).

3.2 Import Dependency and Supply chain Approach

3.2.1 Summary

In the previous criticality assessments (EC 2011, 2014), the supply risk was estimated based on the mix of Global supplier countries only. However, this does not capture the fact that Europe may depend on a combination of supplier countries different from the global supply mix. In addition, the import dependency of the EU is not captured. The fraction of a raw material imported to the EU gives an indication of Europe's reliance on resources produced in other regions over which it may have limited influence. In the revised methodology, the actual supply to the EU (EU sourcing) is used in combination with the global supply in order to calculate a more representative measure of the risk. Moreover, a supply chain approach is systematically adopted (bottleneck screening) in order to assess the likelihood of more than one stage being critical (e.g. mining and refining).

3.2.2 Import dependency and its use in connection with Global suppliers mix, Actual sourcing and Supply chain approach

Today's raw material markets are global and the European economy requires a wide variety of raw materials for its proper functioning. In the previous criticality reports (EC 2011, 2014), the supply risk was estimated based solely on the mix of global supplier countries. In the revised methodology, the actual supply to the EU, i.e., the mix of domestic production plus imports, are used in combination with the global suppliers mix in order to calculate a more representative measure of the risk for the EU (see Figure 4 and Figure 5).

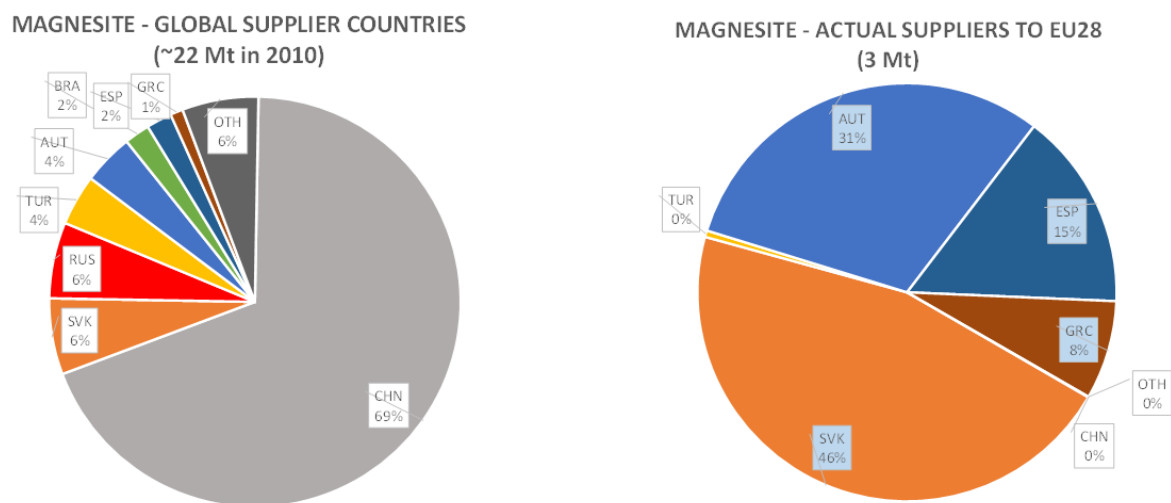

Figure 4 Example: Global Supply of magnesite (left) and actual EU sourcing (right).

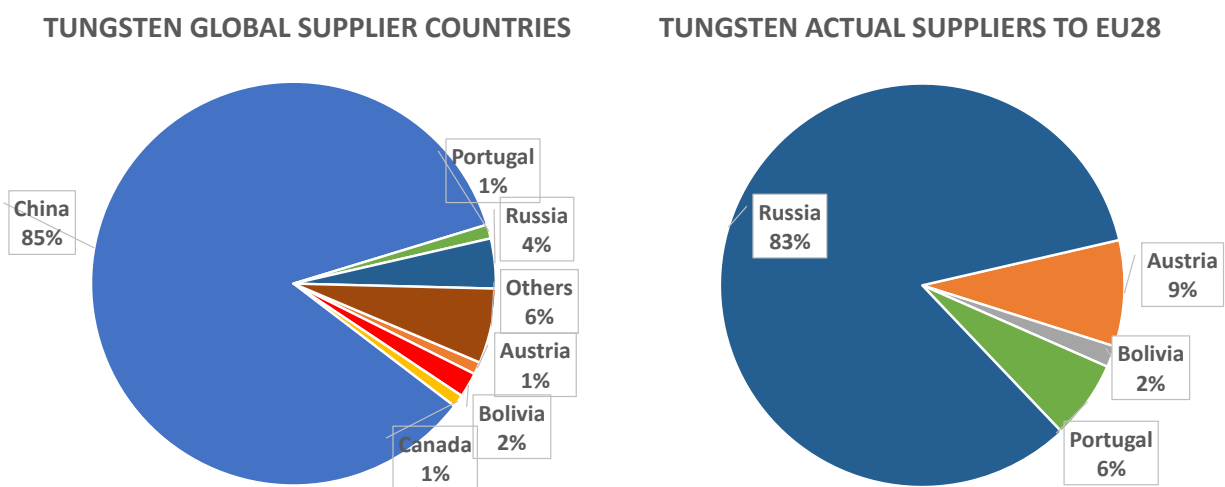

Figure 5 Example: Global Supply of tungsten (left) and actual EU sourcing (right).

Data availability and quality, together with international trade dynamics suggest using both approaches in combination. In fact, data availability and quality suggest that, although it is not a true measure of the risk specific to the EU, the risk calculated using global supply is a more stable calculation and more reliable in terms of data quality. Moreover, the mix of global suppliers is sometimes more stable in time, whereas the exporters to the EU might change more rapidly. Therefore, in the revised methodology a balanced approach between a more representative measure of the risk, but of lower quality, and a more reliable measure, but less representative, is used in the evaluation of supply risk.

An appropriate driver to balance the two measures of the supply risk, i.e., the one based on Global Supply and the one based on the actual sourcing, is the Import Reliance (IR):

- $IR = \text{Net Import} / \text{Apparent Consumption}$;
- $\text{Apparent consumption} = \text{domestic production} + \text{Import} - \text{Export}$.

In the revised methodology, when IR is 100%, the risk is the average of the two measures, i.e. 50% based on global supply and 50% based on actual EU sourcing.

In those cases where EU is independent from import (IR=0), the global supply mix is disregarded and the risk is entirely calculated based on the actual sourcing.

When the EU is a net exporter (i.e. IR<0), IR is made equal to zero for the calculation of the SR, but the actual IR is reported in the factsheet.

The result of the above line of reasoning is the comprehensive formula⁶:

$$SR = \left[(HHI_{WGI-t})_{GS} \cdot \frac{IR}{2} + (HHI_{WGI-t})_{EUsourcing} \left(1 - \frac{IR}{2} \right) \right] \cdot (1 - EOLRIR) \cdot SI_{SR}$$

In this formula, SR stands for supply risk; HHI the Herfindahl Hirschman Index (used as a proxy for country concentration); WGI is the scaled World Governance Index (used as a proxy for country governance) (see section 3.3); t equals the trade adjustment (of WGI) (see section 3.4); IR stands for Import Reliance (this section); GS stands for global supplier mix; EUsourcing stands for the actual sourcing of the supply to the 28 EU Member States; EOLRIR is the End-of-Life Recycling Input Rate (see section 3.5); and SI_{SR} = Substitution Index related to supply risk (see section 3.6).

The above formula and underlying approach are to be systematically adopted, except for cases where the data are not available, or not of sufficiently high quality.

Example: For Gallium (IR=0) or Indium (IR=100), the calculation of supply risk is likely to remain based on global production capacities, unless better data are found.

Deviations must be reported and duly justified in the raw materials factsheets.

⁶Please note, that each component of this revised formula is explained in detail in the subsequent sections of chapter 3 of this report.

Revision of the current methodology:

Given that the true supply of raw materials to Europe may not always correspond with the global supply mix, in the revised methodology the actual EU sourcing and the level of import dependency are taken into account in the calculation of supply risk.

Supply chain approach (bottleneck screening):

For the calculation of supply risk, it is recommended to consider the weakest point in the supply chain, i.e., the stage with the highest supply concentration⁷.

See section 5.5 for a more detailed discussion.

For the proposed methodological improvement, the following data are necessary:

- Global supply
- Import / Export to/from EU28

The above data must be combined to obtain IR and the actual sourcing. We recommend to always report the above data (absolute and in %) in the single raw materials factsheets.

Only in case the above data are available and of sufficiently high-quality the proposed methodology can be applied (weighted average of risk calculated on global supply and actual supply to the EU28). Data unavailability and/or low quality might suggest to estimate the risk based on global supply only (previous methodology) or production capacity (specific cases e.g. Indium). Simulations of the impact of the revised methodology are reported in the Annex.

Remark: A correction factor for trade barriers and agreements (t) is to be calculated to adjust the Supply risk (see section 3.4).

For future research: The incorporation of bottlenecks into the supply risk calculation might be explored by the JRC. Various approaches exist, e.g., considering the life-cycle stage with the highest supply concentration as a bottleneck, weighting the country concentration with WGI (applicable to all life-cycle stages), or considering alternative indicators (e.g., the Policy Perception Index) to only weight the mining stage.

⁷ The risk is essentially a combination of both country concentration and country risk and an alternative approach would be to consider this in the screening for bottlenecks, which would however introduce further calculation burdens.

3.3 World Governance Index and Alternative Approaches

3.3.1 Summary

This section compares different indicators and approaches to assess the conditions for raw materials production in producing countries as a proxy in the calculation of SR. The Worldwide Governance Indicators (WGI) were used in previous criticality exercises (EC 2011, 2014) to take into account SR originating from concentrated primary supply from countries exhibiting poor governance. The analysis includes review of the information provided by different country-level indicators and approaches⁸, and the mathematical correlation between WGI and these alternatives. Even though WGI is not a production specific index, we find that WGI presents a suitable approach for including governance issues in the SR calculation. It provides country-level information relevant to the whole raw material value chain, and it can be used in the context of both abiotic and biotic materials.

In the following, background information about the use of WGI in the EC criticality reports (EC 2011, 2014) is given (section 3.3.2). This is followed by details about the content and data sources used for the computation of each WGI dimension (section 3.3.3). Finally, with the purpose of assessing the need/adequacy of using all WGI dimensions, a qualitative assessment of the WGI dimensions is provided, and complemented by a correlation analysis between WGI dimensions.

3.3.2 WGI in previous criticality studies

In the 2010 criticality report the WGI were used to weight the supply risk (originating from country production concentration).

$$HHI_{WGI} = \sum_c (S_c)^2 WGI_c$$

where HHI_{WGI} is the Herfindahl–Hirschmann Index, considering the WGI value of the country where each material is produced; and S_c is the share of the country in world production of each material.

In this calculation, an average of the six WGI dimensions was used as a proxy of the *political and economic stability of the producing countries*. Among possible concerns raised, linked to supply risk, the study by (Chapman et al. 2013) highlights that WGI does not specifically look at the mining sector in a country⁹. These discussions concluded that, compared to other existing country-level indices¹⁰, the use of WGI is preferable given its broader coverage and wide level of acceptance.

⁸This includes the Extractive Industries Transparency Initiative (EITI), Revenue Watch Institute’s Resource Governance Index (RGI), and Policy Perception Index (PPI).

⁹ See section 5.3.1 in the study by (Chapman et al. 2013).

¹⁰ The study by (Chapman et al. 2013) looked, at the Extractive Industries Transparency Initiative, Revenue Watch Institute’s Resource Governance Index, and the Fraser Institute’s Mining Policy Potential Index.

3.3.3 WGI Analysis

WGI: methodology and data sources

The WGI consists of six indices providing information about the perception of different dimensions of governance (Table 2): Voice and Accountability (VA), Political Stability and Absence of Violence/Terrorism (PV), Government Effectiveness (GE), Regulatory Quality (RQ), Rule of Law (RL), and Control of Corruption (CC). This set of indices has been reported since year 1996, with the last update corresponding to 2013 data and a global coverage of 215 countries.

WGI are based on data sources capturing the perception of governance rather than providing results from direct measurements of tangible variables (e.g., income or employment). As such, WGI relies on surveys carried out by different stakeholders. Given that this might introduce subjectivity in the results, the WGI six dimensions' values for each country, called estimates, are reported always together with their standard error. The following are the four typologies of WGI data sources, most of them publicly available (see the full list and more details in **Annex**):

- **Surveys of households and firms:** Nine data sources including the Afrobarometer surveys, Gallup World Poll, and the Global Competitiveness Report survey.
- **Commercial business information providers:** Four data sources including the Economist Intelligence Unit, Global Insight, and Political Risk Services.
- **Non-governmental organizations:** Eleven data sources including Global Integrity, Freedom House, and Reporters Without Borders.
- **Public sector organizations:** Eight data sources including the Country Policy and Institutional Assessment (CPIA) of the World Bank and regional development banks, the European Bank for Reconstruction and Development (EBRD) Transition Report, and the French Ministry of Finance Institutional Profiles Database.

The information provided by these data sources is assigned to the respective governance dimension/s and the original reported values are rescaled to values between 0-1 (where values closer to 1 translate into a better governance situation). If data sources provide more than one value for a dimension (e.g., a survey including 3 questions on Regulatory Quality), the values are averaged. Then a statistical approach¹¹ is applied to determine how much weight of each data source should be given to each respective governance dimension.

Remarks on the information represented by WGI

WGI Scope: As can be noted from the data sources detailed in Table 2, despite their broad data coverage, WGI indices do not incorporate information on governance specifically related to the raw materials sectors.

Also, since the WGI provide average figures with regard to various governance aspects in a country, the indicators are not strongly influenced by changes in some specific aspects that may be supply risk determinants (e.g., trade barriers and agreements).

¹¹ Unobserved components model.

Table 2 Governance areas and dimensions covered by the WGI, with detail on the data sources assigned to each dimension. Source: Adapted from Kaufmann et al., 2014 (description of WGI dimensions) and Kaufmann et al., 2009 - Appendix B (type of data sources).

Governance notion/area	Dimension	Description	Type of data sources
The process by which governments are selected, monitored and replaced.	Voice and Accountability (VA)	Capturing perceptions of the extent to which a country's citizens are able to participate in selecting their government, as well as freedom of expression, freedom of association, and a free media.	Human rights, democracy, freedom, military involvement in politics, transparency and accountability, representativeness, trust in the government, media.
	Political Stability and Absence of Violence/Terrorism (PV)	Capturing perceptions of the likelihood that the government will be destabilized or overthrown by unconstitutional or violent means, including politically-motivated violence and terrorism.	Societal conflicts, risk of insurgency, coercive measures, war, terrorism, international tensions, torture/disappearances/killings.
The capacity of the government to effectively formulate and implement sound policies.	Government Effectiveness (GE)	Capturing perceptions of the quality of public services, the quality of the civil service and the degree of its independence from political pressures, the quality of policy formulation and implementation, and the credibility of the government's commitment to such policies.	Government structure and quality, bureaucracy quality, policy consistency and forward planning, public services and infrastructure, use of resources, budget management.
	Regulatory Quality (RQ)	Capturing perceptions of the ability of the government to formulate and implement sound policies and regulations that permit and promote private sector development.	Trade regulation, ownership, economic policy including prices and taxes, foreign investment, free market, banking/financing, entrepreneurship.
The respect of citizens and the state for the institutions that govern economic and social interactions among them.	Rule of Law (RL)	Capturing perceptions of the extent to which agents have confidence in and abide by the rules of society, and in particular the quality of contract enforcement, property rights, the police, and the courts, as well as the likelihood of crime and violence.	Security of contracts, financial assets, crime, judicial processes, intellectual property, property rights, tax evasion.
	Control of Corruption (CC)	Capturing perceptions of the extent to which public power is exercised for private gain, including both petty and grand forms of corruption, as well as "capture" of the state by elites and private interests.	Corruption, transparency, anti-corruption measures.

WGI dimensions: scope and correlation analysis

Given the broad scope of WGI, which provides information on six governance dimensions, we first assessed whether all dimensions seem to be qualitatively relevant to the scope of the criticality study. This qualitative analysis was complemented by a quantitative analysis looking at the correlation between WGI dimensions. This analysis serves to assess whether each WGI dimension incorporates information that is not reflected by the other dimensions. Correlation was computed between the average of all WGI dimensions and the WGI dimensions considered more relevant to the criticality assessment (as explained in the following section).

WGI dimensions and the scope of the study

Considering the specific variables and data sources used to compute each WGI dimension (see Table 2 above), the following dimensions appeared as being the most relevant to the criticality assessment: Regulatory Quality (RQ) and Rule of Law (RL), which would allow addressing the regulatory component of the supply risk; and Political Stability and Absence of Violence/Terrorism (PV), which would address the geopolitical risk associated with more extreme events (e.g., war, conflicts, and insurgency). The remaining dimensions (VA, GE and CC) do not appear as particularly relevant to the scope of this work.

- **Regulatory Quality (RQ):** Includes information about the perception of the conditions that make possible the development of the private sector in a country. This is relevant for the capacity of the country to sustain the raw materials industry. This WGI dimension includes economic and political aspects such as trade regulation, ownership, economic policy (including prices and taxes), foreign investment, free market, banking/financing, and entrepreneurship. It allows addressing the regulatory component of supply risk. However, this dimension might be limited due to its focus only on governmental aspects.
- **Rule of law (RL):** Examines the perception of the extent to which agents have confidence in and abide by the rules of society, and in particular the quality of contract enforcement, property rights, the police, and the courts, as well as the likelihood of crime and violence occurrence. This WGI dimension therefore uses data on, e.g., security of contracts, financial assets, crime, judicial processes, intellectual property, property rights, and tax evasion. Therefore, it appears also relevant to the capacity of the country to sustain the raw materials industry. As with the RQ dimension, RL allows addressing the regulatory component of supply risk. In addition, this WGI dimension has a wider scope than RQ, since it addresses aspects regarding the whole society and not only the quality of the regulation developed by the government (as RQ does).
- **Political Stability and Absence of Violence/Terrorism (PV):** Assesses perceptions regarding the likelihood that the government will be destabilized or overthrown by unconstitutional or violent means, including politically-motivated violence and terrorism. Thus, it addresses societal conflicts, risk of insurgency, coercive measures, war, terrorism, international tensions, as issues such as torture/disappearances/killings. PV can therefore complement the information provided by the RQ and RL dimension on regulation by incorporating the geopolitical risk associated with more extreme events that might threaten raw materials supply.

Correlation between WGI dimensions

The high level of correlation between the different WGI dimensions is widely recognized. For example, although each indicator uses different sources of information and data, governance aspects (e.g., accountability and corruption) are often strongly correlated.

The correlation between the three WGI dimensions RQ, RL, and PV (pointed out above as more suitable to the scope of the criticality study) was analysed to assess the extent to which the WGI indices are related to each other. This provides insights into whether the average of all WGI dimensions (current approach) allows for a good representation of the information contained in the RQ, RL, and PV dimensions of WGI.

We find that correlation is very high between the average of all WGI dimensions and the dimensions considered as more adapted to the scope of the criticality study (i.e., RL, RQ, and PV) (Table 3). This shows that using the average of all WGI dimensions, as the current approach does, properly represents the information contained in those three WGI dimensions.

Table 3 Correlation coefficient between the three WGI dimensions considered qualitatively more relevant to the scope of the study (i.e., Rule of Law (RL), Regulatory Quality (RQ) and Political Stability and Absence of Violence/Terrorism (PV)). Source: our elaboration base on 2013 WGI data (correlation was computed using only WGI values of producing countries as considered in the 2013 criticality study).

	Average of all WGI dimensions	PV	RQ	RL
Average of all WGI dimensions	1	0.84	0.92	0.98
PV	0.84	1	0.63	0.80
RQ	0.92	0.63	1	0.88
RL	0.98	0.80	0.88	1

Furthermore, we find that the WGI dimensions RL and RQ are highly correlated with each other (correlation coefficient close to 0.9), while correlation of both dimensions to PV is more moderate. This shows that PV provides information not totally embedded in the RL and RQ dimensions. Therefore, if the geopolitical component of supply risk were to be addressed, the PV dimension should be selected. In order to address the regulatory component of supply risk, any of the WGI regulatory dimensions (RL or RQ) could be used given their high level of correlation.

3.3.4 Alternative approaches to WGI

Since the WGI does not specifically address governance related to the raw materials sector, the 2013 criticality study (Chapman et al. 2013) considered mining governance among the influences to supply risk that were not incorporated in the methodology but that were discussed (see section 5 on *Additional Influences* of that study).

Three approaches/schemes were assessed by that study, concluding that their *limited coverage of materials and/or countries (...)* will mean that they will have *little influence over supply risk* and they won't allow for a universal application of the method. It was also found that *data aligned well with the WGI*. However, it was also pointed out that *in the longer term development of these schemes may help to reduce supply risk concerns*.

These alternative indicators, detailed in the following, have been further analysed in order to assess if they might have overcome the previous limitations:

- **Extractive Industries Transparency Initiative (EITI)**. It expresses the willingness to demonstrate transparency and accountability in the field of oil, gas and mining in a country.
- **Revenue Watch Institute's Resource Governance Index (RGI)**. It gives indication of the quality of governance for natural resources, which intends measuring transparency across rich in oil/gas/minerals reserves-countries.
- **Policy Perception Index (PPI)**. This index, previously denominated Policy Potential Index, measures the opinion about the effects of government policy on attitudes toward exploration investment in mining jurisdictions.

In this section these three approaches will be assessed considering:

- **Scope**, in order to assess if the approach is relevant to the study, which should address key governance aspects related to the risk of raw materials supply. Ideally, suitable approaches will consider the mining stage but also post/mining (smelting, refining) activities, and will apply to biotic and abiotic raw materials.
- **Correlation to WGI values**. If values provided by the alternative approach are highly correlated to WGI values, this will mean that it is not providing additional information as compared to WGI. In such cases, preference will be given to WGI in order to allow comparability among previous and present studies.
- **Geographic coverage**. A good coverage of producer countries by the alternative approach will be needed in order to guarantee the universal application of the supply risk calculation.

Extractive Industries Transparency Initiative (EITI)

EITI scope

EITI expresses the willingness to demonstrate transparency and accountability in the field of oil, gas, and mining in a country. EITI does not cover biotic materials.

It is a scheme in which a country can voluntarily engage. In the report that has to be provided to engage in the scheme, company payments to governments (royalties, taxes, etc.) and government revenues are compared and reconciled. EITI requirements are detailed in Table 4.

Table 4 EITI requirements.

<p>EITI requirements (extracted from (Chapman et al. 2013))</p> <p>The full requirements of the scheme are described by the EITI standard¹², however the seven main components of the EITI can be summarised:</p> <ol style="list-style-type: none">1. Effective oversight by the multi-stakeholder group2. Timely publication of EITI reports3. EITI Reports that include contextual information about the extractive industries4. The production of comprehensive EITI reports that include full government disclosure of extractive industry revenues, and disclosure of all material payments to government by oil, gas and mining companies5. A credible assurance process applying international standards6. EITI reports that are comprehensible, actively promoted, publicly accessible, and contribute to public debate7. That the multi-stakeholder group takes steps to act on lessons learned and review the outcomes and impact of EITI implementation.
--

Starting in year 2002, developing nations have been the first to sign this scheme and most of the compliant countries show very low WGI levels. This shows that more than quantifying transparency and accountability, EITI is an indication of the *willingness* of the minerals, oil and gas sectors to achieve them.

EITI geographic coverage

As found in (Chapman et al. 2013), the coverage of this scheme was very limited: the majority of raw materials were produced outside EITI countries (e.g., the 20 most important producers). This did not allow for the use of this information universally for all materials. Overall there was also little coverage of critical raw materials production, particularly for the compliant countries, but also for the candidate countries, except for chromium and gallium from Kazakhstan. Although China and other G8 countries have expressed their support to the scheme, it was considered in (Chapman et al. 2013) that considering the EITI scheme will not adjust the supply risk of materials significantly.

Since the 2013 criticality study (Chapman et al. 2013), EITI coverage has not experienced relevant changes (Figure 6). Particularly the most significant producing countries not involved in this scheme, as reported in (Chapman et al. 2013) are still out of this scheme, namely Brazil, Chile, China, Greece, India, Japan, Mexico, Russia, South Africa, and Turkey. In addition, other countries that were in the sign up phase at the time of the 2013 study are currently not included, e.g., France, Italy, Germany, Canada, and Australia.

¹² <http://eiti.org/eiti/requirements>

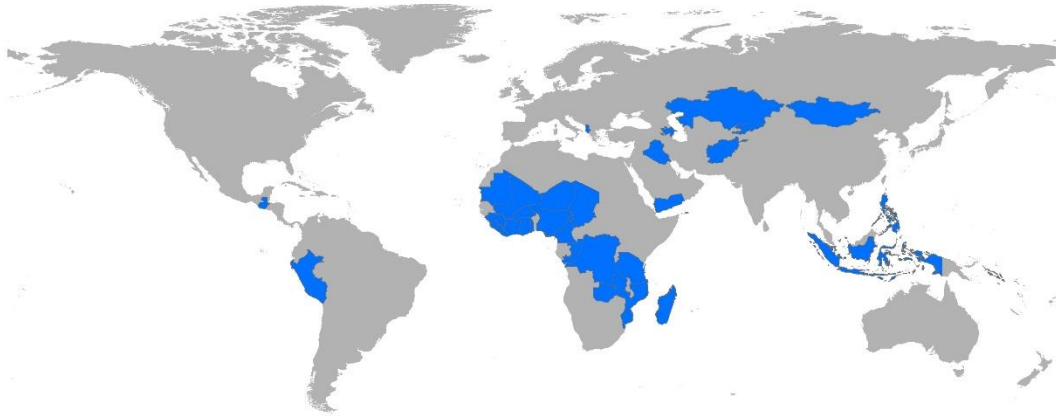

Afghanistan	Ghana	Madagascar	Philippines
Albania	Guatemala	Mali	Republic of the Congo
Azerbaijan	Guinea	Mauritania	Sierra Leone
Burkina Faso	Indonesia	Mongolia	Solomon Islands
Cameroon	Iraq	Mozambique	Tanzania
Chad	Kazakhstan	Niger	Togo
Côte d'Ivoire	Kyrgyz Republic	Nigeria	Yemen
Democratic Republic of Congo	Liberia	Peru	Zambia

Figure 6 Countries for which EITI is reported considering minerals (this includes mining alone and combinations of mining with other extractive activities, e.g., oil and, gas). Years 2011-2013. Source: our elaboration based on EITI data (downloaded from <https://eiti.org/countries/reports>, June 2015).

Remark on the potential use of EITI: Despite the limited coverage of the indicator, its information could complement the use of WGI for those countries which are compliant with the reporting scheme. A country's level of transparency in reporting about its domestic mining activities may be relevant also to the supply risk determination.

Given the limited number of countries covered by EITI, correlation analyses between WGI and EITI were not carried out.

Revenue Watch Institute's Resource Governance Index (RGI)

RGI scope

RGI is an indicator of the quality of governance for natural resources, which intends measuring transparency across countries that are rich in oil, gas and/or minerals reserves. RGI does not cover biotic materials. RGI is a very specific and complete hybrid construct, which integrates information on perceptions from both experts and measurable variables, including a wide range of administrative components such as licensing and contracts. It is a composite index –similarly to WGI– that addresses 4 components, each of them composed of several indicators (see Figure 7):

- Institutional and legal setting: 10 indicators, including also participation on the above mentioned EITI scheme.
- Reporting practices: 20 indicators including mostly economic, administrative aspects.
- Safeguard and quality controls: 15 indicators, including license checks and audits, among other.
- Enabling environment: 5 indicators, including also some dimensions of WGI (VA, GE, RL and CC).

The first three components are extractive industry-specific, while the last component addresses the governance environment in the country in a broader sense. According to RGI results, countries are classified in 4 categories – *satisfactory*, 71-100; *partial*, 51-70, *weak*, 41- 50; *failing*, 0-39).

As for the methodology, it is very remarkable that part of the information integrated in RGI comes for *ad hoc* research work¹³, where many stakeholders are asked to respond an extensive questionnaire¹⁴. The researchers' team includes local experts as well as consultants. Researchers are responsible for analysing and clustering this information, together with indicators provided by other institutions such the International Budget Partnership, Transparency International and the World Bank.

¹³ The RGI information assessed in the 2013 criticality report was based on the analysis of indicators and questionnaire results carried out in year 2012.

¹⁴ Based on the standards by the International Monetary Fund's 2007 Guide on Resource Revenue Transparency and the Extractive Industries Transparency Initiative (EITI), among others. To be found at <http://www.resourcegovernance.org/sites/default/files/RGI%20Questionnaire%202012.pdf>

Institutional & Legal Setting		Reporting Practices		Safeguards & Quality Controls		Enabling Environment	
Indicators	Questions	Indicators	Questions	Indicators	Questions	Indicators	Sources*
Freedom of information law		Licensing process	Information before licensing	Checks on licensing process	Limits to discretionary powers	Accountability and democracy	WGI voice & accountability
Comprehensive sector legislation			Information after licensing		Legislative oversight		EIU Democracy Index
EITI participation		Contracts			Appeal process available	Open budget	IBP Open Budget Index
Independent licensing process	Licensing authority independent from SOC	Environmental and social impact assessments	EI assessment	Checks on budgetary process	Legislative oversight	Government effectiveness	WGI
	Open and competitive licensing process		SI assessment		Review of revenue by national audit institution		Rule of law
Environmental and social impact assessments required	Requirement of EI assessment	Exploration data	Reserves		Quality of government reports	Legislature reviews audit reports	Corruption
	Requirement of SI assessment		Investment in exploration	Understandable reports		WGI control of corruption	
Clarity in revenue collection	Clear authority to collect payments	Production volumes	Production volumes	Government disclosure of conflicts of interest	Timely reports		
	Clear transfers of payments to treasury		Production data by company and/or block				
Comprehensive public sector balance	Includes SOC balance	Production value	Value of resource exports	Quality of SOC reports	Understandable reports		
	Includes fund balance		Production costs		Timely reports		
	Includes non-resource balance		Prices	Reports are audited			
SOC financial reports required		Primary sources of revenue	Value of production streams	SOC reports audited	Audited reports are published		
Fund rules defined in law	Rules for deposits		Government's share in PSCs		Government's share in PSCs	SOC audits include subsidiaries	
	Subnational transfer rules defined in law	Rules for disbursements	Royalties	SOC use of international accounting standards			
			Special taxes	SOC disclosure of conflicts of interest			
		Secondary sources of revenue	Dividends	Quality of fund reports	Understandable reports		
			Bonuses		Timely reports		
			License fees	Fund reports audited	Reports are audited		
			Acreege fees	Audited reports are published			
			Other	Checks on fund spending			
		Subsidies		Government follows fund rules	Practice for deposits		
		Operating company names		Fund disclosure of conflicts of interest	Practice for disbursement		
		Comprehensive SOC reports	Cash flow statements	Fund disclosure of conflicts of interest			
			Joint ventures		Quality of subnational transfer reports	Understandable reports	
		SOC production data	Reserves	Government follows subnational transfer rules	Timely reports		
			Production volumes				
			Prices				
			Value of resource exports				
			Investment in exploration				
		SOC revenue data	Production costs				
			Production data by company and/or block				
			Value of production streams				
			Government's share in PSCs				
			Royalties				
		SOC quasi fiscal activities	Special taxes				
			Dividends				
			Bonuses				
			License fees				
			Acreege fees				
		SOC board of directors	Other				
			Comprehensive and quantitative data				
		Comprehensive fund reports	Timely data				
			Fund rules	Composition			
		Comprehensive subnational transfer reports	Decision-making rules				
			Subnational transfer rules				
		Subnational reporting of transfers					

Figure 7 RGI components. Source: National Resources Governance Institute (<http://www.resourcegovernance.org/rgi/methodology>).

RGI coverage

As above mentioned, RGI includes not only mineral resources activities but also the oil and gas sectors. Among those three, the index value that is assigned to each country will correspond only to the sector with the highest economic relevance in the country. This is one of the reasons why this index has a limited coverage: while 58 countries were covered by the 2013 RGI release, only RGI values for 18 countries mirror values associated to mineral resources (Figure 8). This limited coverage has not been currently overcome since no new release of the index has taken place. Therefore, RGI is not suggested to be incorporated in the criticality methodology. Further coverage in the future might allow for an integration into criticality studies - there is currently a Call for Researchers open for the Resource Governance Index 2016.

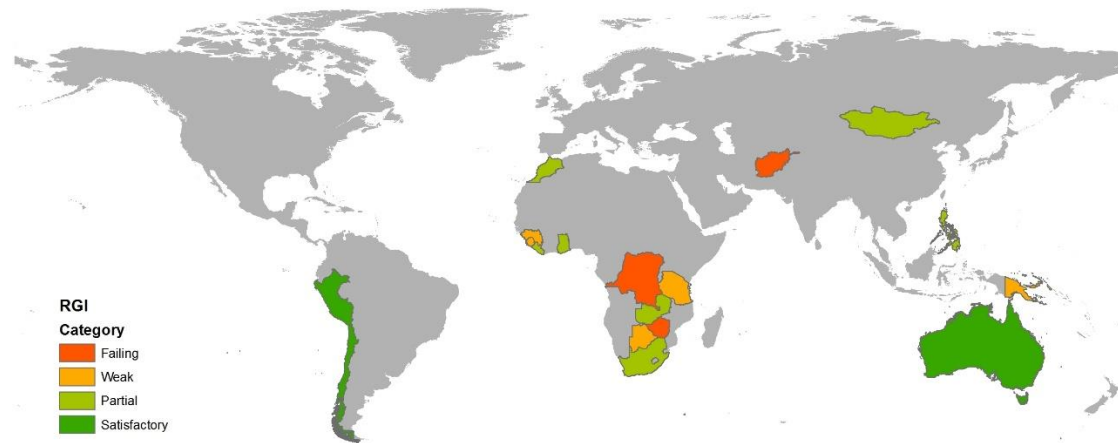

Australia (Western)	Mongolia
Chile	Tanzania
Peru	Botswana
Ghana	Guinea
Liberia	Sierra Leone
Zambia	Papua New Guinea
South Africa	Afghanistan
Philippines	Congo (DRC)
Morocco	Zimbabwe

Figure 8 RGI score for countries where mineral resources were the target of RGI study. Composite indicators values for the last three countries are missing, but lower level indicators are reported. Source: Revenue Watch Institute data, 2013 (downloaded from <http://www.resourcegovernance.org/rgi/downloads>, June 2015).

RGI correlation to WGI

The correlation between RGI and WGI country values was analysed in order to understand if RGI captures relevant information that the WGI - either the average of all dimensions or single dimensions - do not capture. Results show a high correlation overall (Table 4), particularly for the WGI regulatory dimensions (RQ and RL) - while correlation between PV dimension and RGI were lower. This means that WGI is overall a good proxy of the aspects addressed by RGI.

Table 5 Correlation coefficient between RGI and WGI (average of all dimensions and single dimensions).

	RGI
WGI-average all dimensions	0.80
VA	0.80
PV	0.57
GE	0.76
RQ	0.83
RL	0.79
CC	0.78

Policy Perception Index (PPI)

PPI scope

The Policy Perception Index (PPI), previously denominated Policy Potential Index, measures the opinion about the effects of government policy on attitudes toward exploration investment in mining jurisdictions. It is provided by the Fraser Institute’s mining survey (Jackson and Green 2015), which mirrors the opinion of managers and executives of senior and junior companies within the mining jurisdictions and on those policy factors with which they are familiar. PPI does not cover biotic materials. This mining survey had been carried out since year 1997 with the objective of assessing how mineral capacity¹⁵ and public policy (e.g., taxation, regulation) affect investment in exploration.

The PPI covers a total of fifteen topics that are used in the computation of the index (see Table 6), including, e.g., uncertainty concerning existing regulations and over environmental regulation, taxation regime, infrastructure, trade barriers, political stability, and labour regulations.

The 2013 criticality study (Chapman et al. 2013) considered that given that the focus of the survey is on exploration investments, PPI would be better used as part of a *forward analysis (...)* to assess which materials have simplest potential for growth in supply.

¹⁵ Information about mineral capacity is integrated in other indicators provided by the Fraser Institute (Current Mineral Potential Index, Best Practices Mineral Potential Index and Investment Attractiveness Index).

Table 6 Fraser Institute mining survey questionnaire. Source: Fraser Institute, 2015. Survey of Mining Companies 2014 (Jackson and Green 2015).

Mining survey questionnaire (extracted from Fraser Institute, 2015. Survey of Mining Companies 2014)

Survey questionnaire

Respondents are asked to indicate how each of the 15 policy factors influenced company decisions to invest in various jurisdictions. They are also asked to answer two optional questions. The questions about policy factors are:

- 1** Uncertainty concerning the administration, interpretation, or enforcement of existing regulations
- 2** Uncertainty concerning environmental regulations (stability of regulations, consistency and timeliness of regulatory process)
- 3** Regulatory duplication and inconsistencies (includes federal/provincial, federal/state, inter-departmental overlap, etc.)
- 4** Legal system (legal processes that are fair, transparent, non-corrupt, timely, efficiently administered, etc.)
- 5** Taxation regime (includes personal, corporate, payroll, capital, and other taxes, and complexity of tax compliance)
- 6** Uncertainty concerning disputed land claims
- 7** Uncertainty concerning what areas will be protected as wilderness, parks, or archeological sites, etc.
- 8** Infrastructure (includes access to roads, power availability, etc.)
- 9** Socioeconomic agreements/community development conditions (includes local purchasing or processing requirements, or supplying social infrastructure such as schools or hospitals, etc.)
- 10** Trade barriers (tariff and non-tariff barriers, restrictions on profit repatriation, currency restrictions, etc.)
- 11** Political stability
- 12** Labor regulations/employment agreements and labor militancy/work disruptions
- 13** Quality of the geological database (includes quality and scale of maps, ease of access to information, etc.)
- 14** Level of security (includes physical security due to the threat of attack by terrorists, criminals, guerrilla groups, etc.)
- 15** Availability of labor/skills

Possible answers to the question

For each of the 15 factors, respondents were asked to select if the situation at each jurisdiction with which they were familiar:

- Encourages exploration investment
- Not a deterrent to exploration investment
- Is a mild deterrent to exploration investment
- Is a strong deterrent to exploration investment
- Would not pursue exploration investment in this region due to this factor

Additional information

The survey also included questions about the respondents and the type of company they represented, regulatory "horror stories," examples of "exemplary policy," mineral potential assuming current regulation and land use restrictions, mineral potential assuming a "best practices" regulatory environment, the weighting of mineral versus policy factors in investment decisions, and investment spending.

Optional questions

- 1** How the time for permit approval has changed over the last 10 years
- 2** How the cost of transporting goods to market has changed over the last 10 years

Data from the mining survey described above is integrated in the following way to calculate the PPI index for each country. Each jurisdiction is ranked in each policy area assessed by the survey based on the percentage of responses stating that each policy area “encourages investment”. The ranking considering all policy areas is averaged and normalized to 100. Both the values of the aggregated index and the responses to the 15 questions are reported. In addition, analysis for some countries – the same for which data at jurisdiction level are provided - and regions are also given. It is to be noted that the PPI average value in the EU increased after 2013, while dropping in year 2014 (Figure 9).

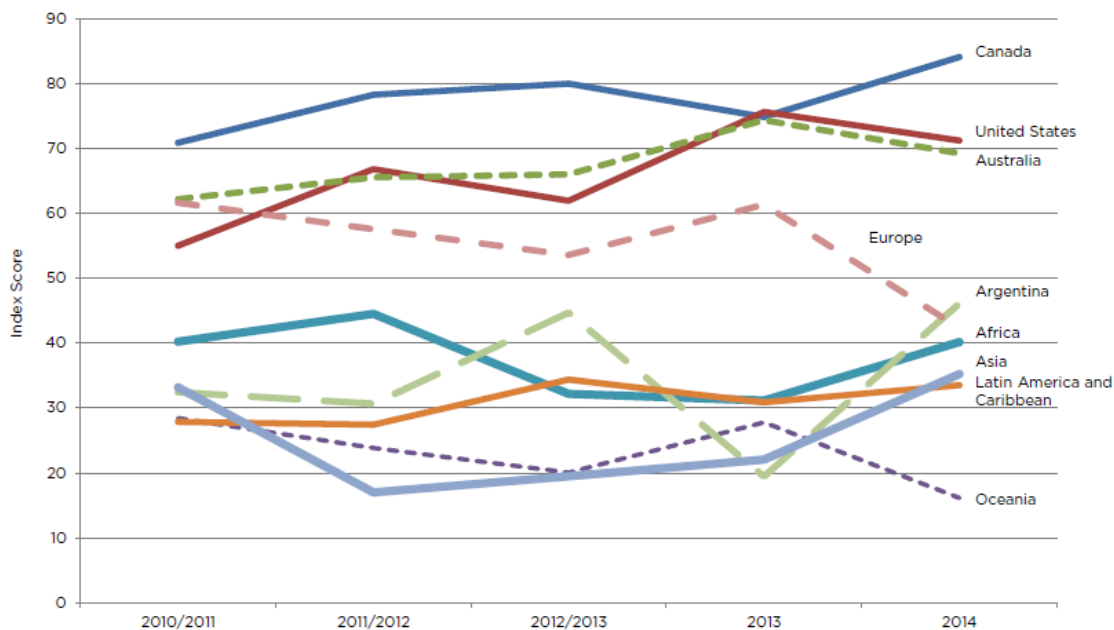

Figure 9 Time trend of the PPI by region (Europe, Africa, Asia, and Latin America and Caribbean) and country (Canada, USA, Australia, and Argentina). Median values are displayed. Source: Fraser Institute, 2015 (Jackson and Green 2015).

Sample design

The mining surveys aims at identifying world regions whose policies are the most attractive for encouraging investment in mining exploration and production. To that aim, a representative sample of the survey is required. Details are given in the 2014 survey report (Jackson and Green 2015) about respondents: 57% respondents were either the company president or vice-president and 27% were either managers or senior managers. Over half of the respondents belonged to exploration companies; over a quarter were producer companies; and over one fifth were consulting and other type of companies.

However, some limitations with regard to survey representativeness of PPI may also exist. Firstly, only 485 responses (390 totally completed) to the survey (out of the 4200 sent)

were received. Secondly, the survey is completed anonymously and contributors¹⁶ to the survey remain confidential. These two aspects make it difficult to assess whether results are representative of the real situation in the country. Examples of how much responses might differ within a country depending on the mining jurisdiction considered can be found for Australia (PPI minimum and maximum value range 25 points) and Argentina (56 points).

PPI geographic coverage

Starting with Canada in year 1997, the geographic coverage of this index has been always increasing. Data is disaggregated at jurisdiction level for some countries – Canada, USA, Australia, and Argentina. As presented in (Chapman et al. 2013), PPI geographic coverage was better than for the other two indicators described above: 58 countries (45% of producing countries), with around 83% coverage of raw materials and 93% of critical raw materials. Yet, PPI was considered limited due to data not being available for large areas of Africa and Middle East. The last release of the indicator shows a widening of the geographic coverage, reaching 84 countries (55% of producing countries (Table 7)).

Table 7 Country coverage by the last release of the PPI. Countries newly covered as compared to the PPI edition analysed in (Chapman et al. 2013) have been highlighted in bold. Source: data downloaded from <https://www.fraserinstitute.org/research-news/display.aspx?id=22259>, July 2015).

Region	Country	
North America	Canada	USA
Oceania	Australia	New Zealand
	Fiji	Papua New Guinea
	Indonesia	Philippines
	Malaysia	Solomon Islands
	Angola	Mali
	Botswana	Mauritania
	Burkina Faso	Morocco
	Central African Republic	Mozambique
	Democratic Republic of Congo (DRC)	Namibia
	Egypt	Niger
	Eritrea	Nigeria
	Ethiopia	Sierra Leone
	Ghana	South Africa
	Guinea(Conakry)	South Sudan
	Ivory Coast	Sudan
	Kenya	Tanzania
	Lesotho	Uganda
	Liberia	Zambia
	Madagascar	Zimbabwe
	Argentina	Guyana
	Bolivia	Honduras
	Brazil	Mexico
	Chile	Nicaragua
	Colombia	Panama
	Dominican Republic	Peru
Latin America and the Caribbean Basin		

¹⁶ The list of potential contributors was compiled from commercially available lists, publicly available membership lists of trade associations, and other sources.

	Ecuador	Suriname
	French Guiana	Uruguay
	Guatemala	Venezuela
Asia	Cambodia	Laos
	China	Mongolia
	India	Myanmar
	Kazakhstan	Thailand
	Kyrgyzstan	Vietnam
		Bulgaria
Europe	Finland	Portugal
	France	Romania
	Greenland	Russia
	Greece	Serbia
	Hungary	Spain
	Ireland	Sweden
	Norway	Turkey

However, the PPI coverage is not as good as for WGI and the fact that values are missing for countries means that the production of some raw materials is not covered. This includes the production of some critical raw materials such as indium, gallium, and phosphate rock (Table 8). Also, more than 20% of the production of materials such as clays, tellurium and selenium takes place in countries not covered by the PPI. **Annex 1.1** provides (1) a detailed list of the raw materials produced in countries not covered by PPI, and (2) information on the sensitivity of the supply risk calculation to missing PPI values.

Table 8 Materials for which a given % of supply is not covered in the last release of PPI (see Annex 1.1 for the details). CRMs in the 2014 list highlighted.

Material	Sum of % of global supply	Material	Sum of % of global supply
Clays	42.20%	Titanium	6.60%
Tellurium	39.00%	Cobalt	6.55%
Selenium	36.80%	Bauxite	5.20%
Potash	35.92%	Molybdenum	4.40%
Feldspar	33.70%	Magnesium	4.15%
Silica sand	28.69%	Barytes	4.10%
Perlite	28.00%	Chromium	4.00%
Indium	25.37%	Natural graphite	4.00%
Gypsum	20.10%	Iron ore	3.90%
Gallium	20.00%	Nickel	3.60%
Talc	18.10%	Gold	3.50%
Tantalum	16.20%	Hafnium	3.13%
Sawn softwood	16.00%	Antimony	3.00%
Limestone	13.70%	Coking coal	2.00%
Manganese	13.20%	Silicon metal	2.00%
Bentonite	12.10%	Tungsten	1.51%
Phosphate rock	12.00%	Fluorspar	1.50%
Diatomite	11.60%	Tin	1.19%
Cork	11.00%	Natural rubber	1.00%
Magnesite	10.00%	Zinc	0.30%
Aluminium	7.90%	Borate	0.02%
Rhenium	7.88%	Copper	0.00%
Pulpwood	7.02%	Vanadium	0.00%

PPI correlation to WGI

As done for RGI above, the correlation between WGI and PPI was analysed. Results showed a moderate-to-high correlation between PPI and WGI, especially for the dimensions RL and CC (Table 9). This means that WGI would be a good proxy of the information addressed by PPI. Correlation of WGI to PPI is lower than to RGI. This means that the information provided by WGI on the governance of countries is less reflected by PPI than by RGI. However, WGI-RGI correlation results are less significant than those of WGI-PPI since the data sample (i.e., the number of countries) was much smaller.

Table 9 Correlation coefficient between PPI and WGI. Source: data downloaded from <https://www.fraserinstitute.org/research-news/display.aspx?id=22259>, July 2015).

	PPI
WGI-average all dimensions	0.69
VA	0.61
PV	0.58
GE	0.62
RQ	0.63
RL	0.70
CC	0.71

3.3.5 The use of WGI in the revised methodology

After reviewing the methodology and the type of results produced by the WGI on the one hand, and assessing the scope, geographic coverage, and correlation to WGI of the three alternative approaches (see Table 10) on the other hand, **WGI has been considered as the most suitable approach** to be the backbone of the supply risk determination.

Continuing using the average of all WGI (six) dimensions is also recommended, given the high level of correlation among dimensions. Also, using the average allows a softer impact of WGI on supply risk results.

None of the proposed alternative methodologies allow for assessing the supply risk of biotic materials, given their focus on mining and extractive activities.

EITI: As found in (Chapman et al. 2013), EITI does not seem to be suited for inclusion in the methodology, which is largely due to its limited country coverage. Also, a straightforward association of EITI and supply risk cannot be established because EITI represents more an indication of the willingness to achieve transparency and accountability rather than a measurement of those two variables.

RGI: The current limited geographic coverage of RGI, as already analysed by (Chapman et al. 2013), and the fact that it embodies information also on other extractive activities out of the scope of this study, prevents suggesting its inclusion in the criticality methodology. Furthermore, RGI does not seem to provide significant additional information as compared

to WGI, since correlation levels are very high. Yet, RGI was found a very valuable approach to natural resources governance, and it is recommended to further investigate future developments. However, in order to be used as part of the methodology, more regular updates of the index would be required.

PPI: The Policy Perception Index was also considered an interesting approach, yet not superior to WGI. On the one hand, the level of correlation between PPI and WGI was not so high, which shows that PPI incorporates information not represented by WGI. Yet, PPI targets specifically the mining sector and does, therefore, not cover in principle further steps in the raw materials supply chain (e.g., smelting, refining, and manufacturing)¹⁷.

Table 10 Comparison of alternative approaches to WGI. Source: our elaboration based on the analysis presented above.

	Scope	Geographic coverage	Correlation to WGI
Extractive Industries Transparency Initiative (EITI)	Partial	Very limited (32 countries)	-
Revenue Watch Institute’s Resource Governance Index (RGI)	Good- partial	Lower than WGI (18 countries)	High
Policy Perception Index (PPI)	Good- partial	Lower than WGI (84 countries)	High-moderate

Confirmation of the current methodology:

→ In the revised methodology, the **WGI should be kept** as indicators able to mirror aspects of country governance that are essential factors determining raw materials supply risk, including governance aspects of the whole country, WGI indirectly embodies all the steps of the raw materials supply chain and is not limited to only abiotic materials (as is the case for the EITI, PPI and RGI).

→ The **WGI should be used as it is currently done, i.e., the average of all WGI dimensions, which appears to be a robust approach.**

¹⁷ It may, however, be applied to the mining stage (using mine production data). This is done, for instance, in the Yale criticality methodology (Graedel et al. 2015)

For future research:

- **Extractive Industries Transparency Initiative (EITI)**. Despite the limited coverage of the indicator, the information could complement the use of WGI. Thus, EITI could be used as a factor reducing the supply risk calculated with the core formulation, for EITI compliant countries.
- **Revenue Watch Institute's Resource Governance Index (RGI)**. Although the limited geographic coverage of RGI leads to not recommending the incorporation of this index to the criticality methodology, further editions might allow for that.
- **Policy Perception Index**. It was considered a very valuable index, yet further research will be needed to assess if the main limitations encountered can be overcome in the next future.
- **WGI**: If specific aspects of country governance were to be addressed in the future (e.g., regulatory framework, geopolitical risk) the use of single WGI dimensions would be more advisable.

Remarks on using governance indicators

When using any of the governance-related indicators/indexes presented here, some aspects should be considered:

-Limited sensitivity to key aspects determining supply risk. Since these indicators/indexes provide average values for the countries considering many aspects, they are limited in their capacity to provide information about factors that could determine the supply risk in very specific conditions (e.g., changes in the tax regime or property rights). For instance, even if trade policy and import/export barriers are embodied in the information used to compute, e.g., WGI and PPI, these indexes will soften these changes as they consider also many other aspects. This supports the need for incorporating the effect of trade barriers and trade agreements in the supply risk calculation, as explained in section 3.4.

-WGI, PPI and some of the RGI aspects are based on perceptions of survey respondents rather than consisting of direct measurements of tangible variables (e.g., income or employment). This means that results might be subjective, since they are based on questions whose content and meaning is sensitive to interpretation and to different cultural backgrounds (e.g., the sense of freedom, corruption, and accountability). The subjective character of perceptions may soften, but also intensify figures.

-Indicators/indices reporting country values will not directly capture conditions/events taking place in specific locations. Therefore, more localized changes in conditions affecting relevant extractive and processing activities will be underrepresented.

-Delayed information. The time it takes to have robust updates of available information is a limitation affecting many components of the criticality methodology. This is also happening for the governance indices included here: WGI is reported, generally, with around 2 years of delay and PPI with 1 year of delay (RGI updates take even more time). This means that the methodology won't have the capacity to incorporate sudden changes, e.g., the political situation in Ukraine, which affected the supply of clays. This might be corrected by more up-to-date information on the trade agreements and restrictions (see section 3.4).

3.4 Trade

3.4.1 Summary

Alongside the governance quality in the supplying countries, measured by the World Governance Index (WGI), the restrictions imposed worldwide on exports of certain raw materials (RMs) can increase the supply risk. On the other hand, concluding trade agreements with the supplying countries can result in more secure supply. However, previous criticality reports (EC 2011, 2014) do not consider aspects of export restrictions and trade agreements in the evaluation of supply risk. In this section we explore how both export restrictions and trade agreements may be included in the calculation of supply risk for adjusting the WGI. We propose to adjust the WGI, which is an important indicator currently used in the supply risk calculation, by an additional trade-related variable. For this, a separate variable, t , was designed which accounts for both the actual export restrictions imposed by some supplying countries and the mitigating effects of international trade agreements.

3.4.2 Export restrictions

Some types of export restrictions are capable of disturbing the smooth supply of RM (e.g., prohibitions on export of a certain RM with a high market concentration) or create market distortions. Especially the more severe cases require careful impact analysis and properly designed trade policy mitigation responses to ensure a continued supply.

Export restrictions are increasingly present in minerals and metals sectors, being mainly driven by national governments' intention to secure the RM domestic supply and/or to stimulate the development of local processing and manufacturing sectors. Also, according to the OECD's Inventory of Restrictions on Exports of Raw Materials the whole range of restrictions (i.e., export taxes, licensing requirements, export prohibitions and other export measures) are imposed by several countries on the export of several products based biotic materials belonging to the following product groups: industrial roundwood coniferous; industrial roundwood non-coniferous tropical; industrial roundwood non-coniferous non-tropical; sawnwood coniferous; sawnwood non-coniferous tropical; sawnwood non-coniferous non-tropical.

The importance of trade restrictions on RM is further supported by the abrupt increase in the number of measures enacted globally after 2009, with more than half of the measures in force in 2012 being introduced after 2009 and almost a quarter in 2012 (Figure 10)¹⁸.

¹⁸ For a detailed analysis, (Fliess and Mård 2012), "Taking Stock of Measures Restricting the Export of Raw Materials: Analysis of OECD Inventory Data", OECD Trade Policy Papers, No. 140, OECD Publishing. <http://dx.doi.org/10.1787/5k91qdmdbtc-en>

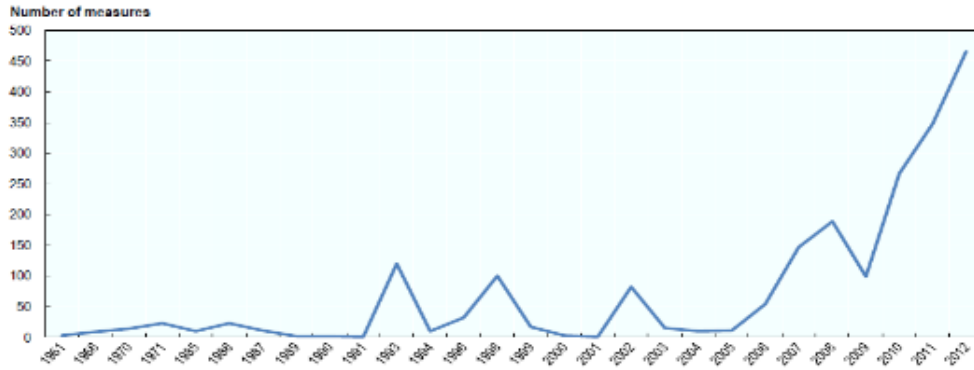

Figure 10 Introduction year of export restrictions in force in 2012 (Source: (Fliess et al. 2014)).

Furthermore, trade barriers add further risk in a context in which the risk of supply disruption is often high due to the combination of high global market concentration and poor country governance (Figure 11).

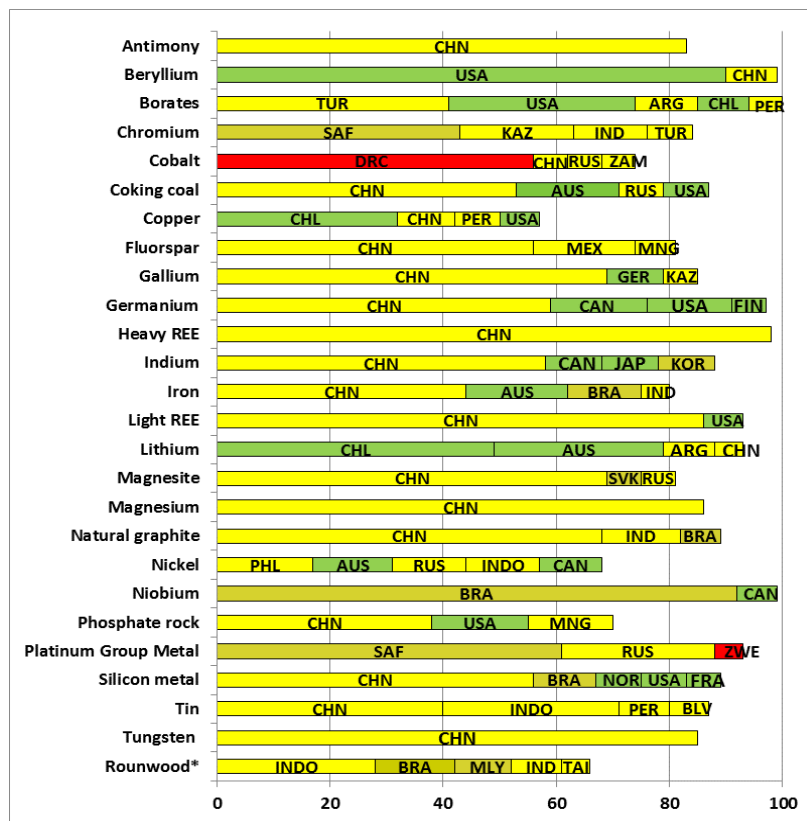

Figure 11 Geographical concentration of raw materials supplier countries and level of governance (based on WGI; red=poor; yellow=intermediate; green=good)¹⁹.

¹⁹ JRC elaboration based on data from the EC report "Study on Critical Raw Materials at EU Level". Legend of producing countries: ARG: Argentina; AUS: Australia; BRA: Brazil; CAN: Canada; CHL: Chile; CHN: China; DRC: Democratic Republic of Congo; FIN: Finland; FRA: France; GER: Germany; IND: India; INDO: Indonesia; JAP:

Figure 12 shows the shares of RM primary production whose supply risk (by country) might increase due to the trade barriers introduced in the period 2009-2012²⁰. We used the same raw materials and the same percentage of world supply as reported in Figure 11 and adopted the following approach: if a country supplying a specific material also applies export restrictions in the specified period, the related world supply share is retained in the graph; on the contrary, if no restrictions are applied, its production share does not show up. Note that the export restrictions referred to in Figure 12 are export quotas, export taxes and license requirements present in the period 2009-2012.

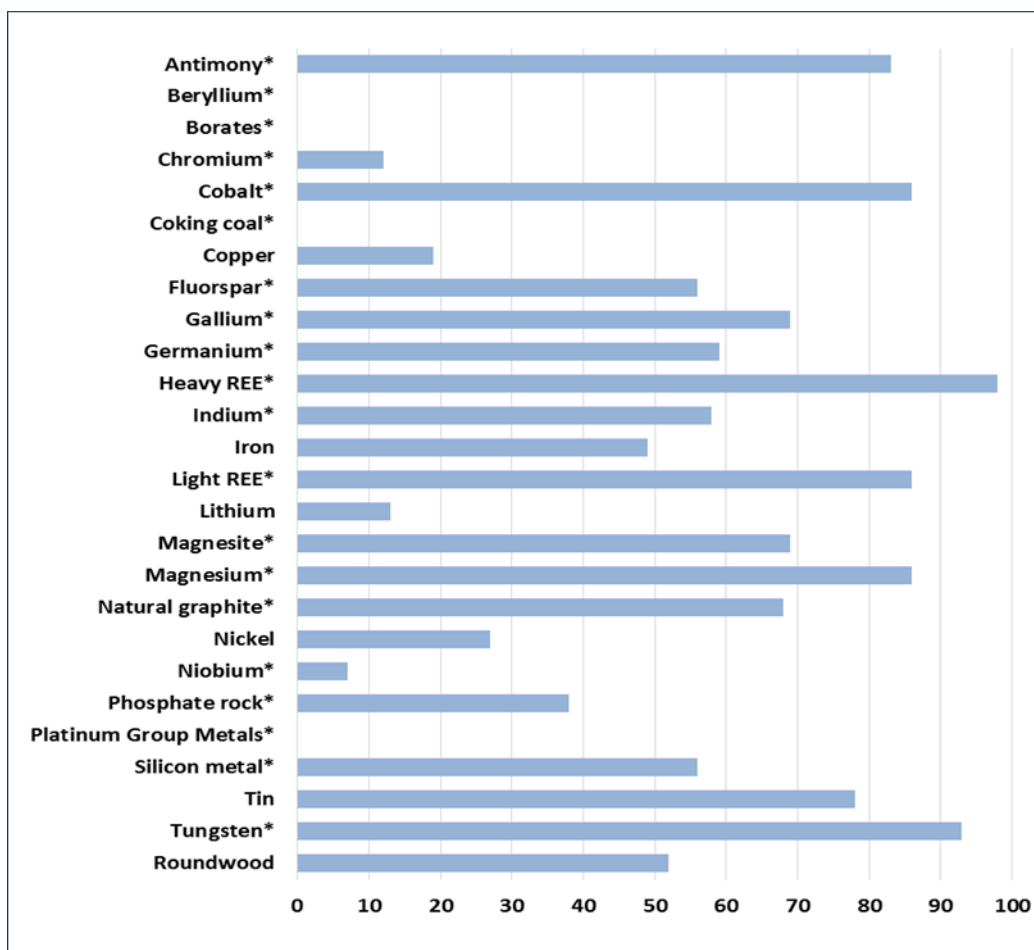

Figure 12 Shares of worldwide RM primary production whose supply was subject to selected trade barriers in the period 2009-2012.

The information reported in Figure 12 can give a first overview, but cannot be used as such in criticality assessment. In fact, the figure only shows that, for a given raw material, a

Japan; KAZ: Kazakhstan; KOR: Republic of Korea; MLY: Malaysia; MEX: Mexico; MNG: Mongolia; MOR: Morocco; NOR: Norway; PER: Peru; RUS: Russian Federation; SAF: South Africa; SVK: Slovakia; TAI: Thailand; TUR: Turkey; ZAM: Zambia; ZWE: Zimbabwe.

²⁰ These are the results of a first analysis based on (1) OECD's Inventory of export restrictions on exports of industrial raw materials (Fliess and Mård 2012) and (2) the candidate CRMs (identified in the report "Study on Critical Raw Materials at EU Level" (Chapman et al. 2013)) and their corresponding primary production shares worldwide.

given country applied one or all three types of measures. No information is provided on the consequences of such measures.

Thus, whereas the existence of additional supply risks related to trade barriers is generally perceived, a quantitative method of translating the generic information (as that reported in OECD's Inventory of Restrictions on Exports of Raw Materials²¹) into a quantitative adjustment of the supply risk of a specific RM is still lacking. For the analysis of the three principal export restrictions (i.e., export taxes, physical quotas, and export prohibitions) on the export of raw materials, we have used the OECD's Inventory of Restrictions on Exports of Raw Materials.

3.4.3 International trade agreements

In principle, international trade agreements (TA) can be considered as a general instrument for mitigating the supply risk. In spite of the variety of existing TA in which the EU is participating (e.g., multilateral trade agreements within the World Trade Organization (WTO) framework, bilateral and regional trade agreements, and unilateral tariff preference schemes), in this assessment *we only retain the EU's bilateral and regional trade agreements, because they seem to be more capable of providing trade exchange stability*. This assumption is supported by the fact that many export restrictions have been imposed in the industrial raw materials sector in the last years under the existing multilateral trade agreements²². A good example is the recently settled trade dispute between the EU and China on China's introduction of export restrictions on several rare earth elements, tungsten, and molybdenum. The EU-China dispute settlement procedure took more than 3 years, which illustrates that temporary supply instability can occur in spite of participation in multilateral trade agreements.

Example: The EU-China dispute on China's export restrictions on several rare Earths, tungsten and molybdenum

Dispute object: EU's request to the WTO regarding China's export restrictions (i.e., export taxes, export quotas, minimum export price requirements, and export licensing requirements) for several rare earths, tungsten, and molybdenum;

Inconsistency complained: Inconsistency with China's Accession Protocol, Working Party Report, Marrakesh Agreement, GATT Arts. XI and XX;

Request date: March 13, 2012

Final dispute settlement date: May 2, 2015

Source: World Trade Organisation, *Dispute settlement, Dispute DS 432, "China - Measures Related to the Exportation of Rare Earths, Tungsten and Molybdenum"*, https://www.wto.org/english/tratop_e/dispu_e/cases_e/ds432_e.htm

²¹ http://qdd.oecd.org/subject.aspx?Subject=ExportRestrictions_IndustrialRawMaterials

²² See (Fliess and Mård 2012) for more details.

The EU bilateral or regional trade agreements in force are listed and grouped by category in Table 11.

Warning: Data on export restrictions and trade agreements need to be used with caution when they are further applied to adjusting supply risk of a specific raw material. Firstly, they sometimes represent partial or general information, which needs to be further explored. As a result, the direction and amplitude of their trade and economic effects cannot always be precisely estimated.

Furthermore, the mitigation effect of bilateral Trade Agreements is only considered in case of co-existence with Export taxes (see further details in the next section).

3.4.4 Construction and use of the trade-related variable

The barriers to free trade of raw materials impact differently the value chain stages (e.g., processing, manufacture, commodity import) which use them. Hence, the extent of their specific economic impact and supply risk posed to the European manufacturing industry needs to be properly clustered (i.e., not mixing various stages of the value chain) and accounted for.

In order to quantify the contribution of trade to increase or reduce supply risk, **we constructed a separate trade-related variable "t"**. In the following paragraphs we present the variable "t" and illustrate its application to metals, with focus on three examples, i.e., lithium, indium, and tungsten. The same approach can be applied to the rest of candidate raw materials, including biotic materials.

In case of metals, the **supply-chain reference scope is RM ores & concentrates**. In case a bottleneck (i.e., the weakest point in the supply chain) is identified elsewhere in the supply chain, the scope is to be adjusted subsequently, e.g., to the refining stage instead of mining. The **time frame is the period 2010–2015**. In our analysis, we take into account the restrictions imposed (i.e., export taxes, physical quotas, and export prohibitions) on exports of RM **at least once in the reference period**. They will be retained even though they were subsequently modified or eliminated, or they are applied for just 1 year out of 5 during the reference period.

Construction method. Supply risk to the EU increases as a result of restrictions imposed on exports of a certain raw material and, in the case of export taxes (details in the *Box*, below), decreases by concluding free trade agreements (FTA) with the supplying countries. Thus, by constructing a parameter "t", which stands for "trade", the impact of both export restrictions and trade agreements is accounted for using a modifier in the calculation of supply risk.

As far as trade agreements are concerned, we only take into account the supply risk mitigating effect on export taxes of the bilateral trade agreements concluded by the EU with the RM supplying countries (Table 11). When in force, the supply risk of the concerned country goes back to the level as if no export tax was applied to the RM.

Table 11 EU bilateral and regional trade agreements in force.

EU preferential trade agreements in force, out of which:			
Customs Union	EEA	bilateral or regional agreements	Economic Partnership Agreements (EPA)
Andorra, Monaco, San Marino, Turkey	Iceland, Lichtenstein, Norway	Albania, Algeria, Bosnia-Herzegovina, Chile, Columbia, Costa Rica, Ecuador, Egypt, El Salvador, Faroe Islands, Iraq, Israel, Jordan, Lebanon, Macedonia, Mexico, Montenegro, Morocco, Nicaragua, Occupied Palestinian Territory, Panama, Peru, Serbia, Syria, Tunisia, South Africa, South Korea, Switzerland	Antigua, Barbados, Barbuda, Belize, Cameroun, Dominican Republic, Fiji, Guatemala, Grenada, Guyana, Haiti, Honduras, Jamaica, Madagascar, Mauritius, Papua New Guinea, Seychelles, St. Kitts and Nevis, St. Lucia, St. Vincent and the Grenadines, Suriname, Trinidad and Tobago, Zimbabwe

Source: DG Trade, Overview of trade agreements,

<http://ec.europa.eu/trade/policy/countries-and-regions/agreements/>

Application of the mitigating effect of the bilateral trade agreement for a certain RM will depend on the concerned RM's coverage by the provisions on export duty in the agreement. Furthermore, the actual mitigation effect of the EU bilateral trade agreements concluded with the country supplying a certain RM will be examined on a case-by-case basis.

Links between export restrictions and EU bilateral trade agreements (FTA)

One important observation is the link that exists between export taxes and the mitigating impact of EU bilateral trade agreements.

There are **three possible cases**:

1) In case a country does not apply export taxes, then there is no impact so no adjustment is needed as the risk is comparable to the EU internal market.

In case a country applies an export tax, there is an increased supply risk, which is:

2) Either mitigated for the EU by a bilateral agreement (subject that the raw material concerned is covered by the provision on export duty in the agreement) – then the supply risk goes back to the level as if no export duty was applied.

3) Or not mitigated on absence of a trade agreement – then the supply risk remains higher as defined in the previous point.

The case of export quotas remains a separate element of supply risk as our FTA cannot guarantee their removal. Mirroring the legal provisions of the WTO our FTAs make reference to the GATT exceptions that may be invoked to justify their use (even though their use is in principle ruled out). Trading partners may use these exceptions and only long WTO dispute settlement proceedings may eventually end up in the removal of the quotas. Therefore, for all practical reasons, impact of quotas cannot be mitigated by the existence of an FTA.

Summary: **There are two distinct trade parameters: one for export taxes (in two steps, yes/no, and if yes including the FTA mitigating factor) and one for export quotas (without mitigating factor).**

Calculation and use of the variable t

Calculation. For the calculation of t we used the following assumptions:

- The mitigation effect of bilateral trade agreements is only considered in the case of export taxes.
- Since we consider the EU trade block as a whole, with free trade inside the EU (i.e., equivalent to lower risk), a value of 0.8 is automatically assigned to t for each EU country.
- For a certain RM, when a country imposes no export restriction, and there is no trade agreement in force, $t = 1$. That means that HHI_{WGI} remains unchanged, with no influence of trade on it being accounted for.
- The maximal theoretical value of t is 2.

Changes to the criticality methodology:

Variable t is constructed as follows:

$$t = (ET_{TA} \text{ or } EQ \text{ or } EP)$$

Where:

- t is the trade-related variable;
- ET_{TA} stands for export tax imposed (%), eventually mitigated by trade agreement (TA) in force;
- EQ is the export physical quota imposed (physical units, e.g. tonnes);
- EP is the export prohibition introduced for a certain RM;

Export taxes contribution to the increase of the supply risk as follows:

$$\begin{aligned} ET &= 1 + 0.10 \quad (0 < ET \leq 25\%) \\ &= 1 + 0.20 \quad (25 < ET \leq 75\%) \\ &= 1 + 0.30 \quad (ET > 75\%) \end{aligned}$$

Export quotas contribution to the increased supply risk:

$$EQ = 1 + (\text{country } i \text{ production of a certain RM} - \text{physical quota imposed}) / \text{total world production}$$

Export prohibition represents an extreme version of export quota (i.e., quota = 0).

When there is more than one restriction, the highest score will be retained.

Use. We adjusted HHI_{WGI} by the variable t to HHI_{WGI-t} in order to take into account the contribution of trade to the supply stability, based on export restrictions' estimated impact (i.e., proportionally, by type). We refer to export taxes, physical export quotas and export prohibitions. Licensing requirements are left aside due to the difficulty of quantifying them. As HHI_{WGI} is calculated and used twice, the first time using Global Suppliers mix data -

$(HHI_{WGI})_{GS}$ - and then using the mix of the Actual Suppliers to EU - $(HHI_{WGI})_{EU\text{sourcing}}$ - t is used to correct HHI_{WGI} both for the Global Suppliers Mix and EU-28 actual sourcing (for the place of t in the Supply Risk – SR - formula and further details, see the beginning of the section 4).

The way t is used for adjusting the HHI_{WGI} for Global Supplier country concentration and concentration of EU28 sourcing is captured in the following formula:

$$(HHI_{WGI-t})_{GS \text{ or } EU\text{sourcing}} = \sum_c (S_c)^2 WGI_c * t_c$$

where:

- HHI_{WGI-t} is the HHI_{WGI} for Global Supplier country concentration *or* concentration of EU28 sourcing adjusted by t .
- S_c is the share of country c in the *global supply (or EU28 sourcing)* of the RM considered;
- WGI_c is the rescaled score in the World Governance Indicators (WGI) of country c ;
- t_c is the value of the trade-related variable t of country c for the RM considered.

Data sources:

- For data on export restrictions, OECD's Inventory of Restrictions on Exports of Raw Materials, http://qdd.oecd.org/subject.aspx?Subject=ExportRestrictions_IndustrialRawMaterials
- For the EU bilateral trade agreement in force, European Commission, DG Trade, Overview of trade agreements, <http://ec.europa.eu/trade/policy/countries-and-regions/agreements/>

Worked examples for Lithium, Indium, and Tungsten are provided in the Annex.

3.5 Secondary raw material and recycling

3.5.1 Summary

The JRC explored further the role of secondary raw materials and recycling in the risk component in respect to what had been done in previous criticality reports (EC 2011, 2014). Beyond the role of recycling, key elements to be investigated were data sources and the related data quality, and representativeness for the EU. Priority was given to EU sources of data such as the Raw Material System Analysis (MSA) study (BIO by Deloitte 2015), commissioned by DG GROW, which covered 28 raw materials. Furthermore, data published in the report 'Recycling Rates of Metals' by the International Resource Panel of the United Nations Environment Programme (UNEP 2011; Graedel et al. 2011) were utilized, partly in order to maintain the highest possible comparability with previous EC criticality reports (EC 2011, 2014). In addition, we explored whether recyclability should be used in the criticality assessment and whether a specific risk is to be associated to secondary sources of supply.

We recommend using MSA data whenever possible because of the focus on material flows in the EU. If MSA data are not available, we recommend using estimates from the UNEP report on recycling. The EOL-RIR was found to be most suitable for use in criticality analysis, because it aligns well with EU targets including raw materials policy, and the section explains how it can be calculated using MSA data.

3.5.2 Introduction

In previous criticality reports (EC 2010, EC 2014), Figure 13 is used to illustrate that the sources of secondary materials are the quantity of materials obtained from recycling new and old scraps. Secondary raw materials from recycling can represent a source of materials which can partially contribute to reduce the overall supply risk.

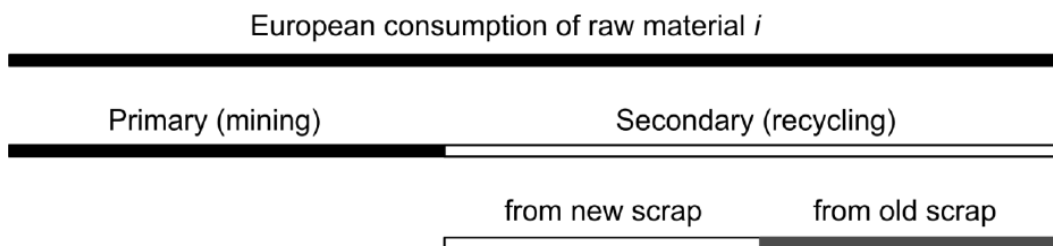

Figure 13 Schematic representation (not to scale) of recycling as included in the EU criticality exercise (EC 2010).

Recycling acts as a risk-reducing filter in the supply risk component (EC 2014) as shown in the formula below. The role of recycling as a variable that can mitigate the supply risk²³ remains as such also in the revised methodology:

$$SR = (HHI_{WGI-t}) \cdot (1 - EOL_{RIR}) \cdot SI_{SR}$$

Please refer to section 1 for an explanation of terms in the equation.

3.5.3 Secondary raw materials, recycling and recyclability

Although recycling and recyclability are terms used as synonyms in some cases, they provide different information. Recycling can be defined at different stages of the life cycle of materials and products (e.g., recycling of production/manufacturing scrap, recycling of end-of-life materials) while recyclability is generally defined at the end of life (EOL) based on the amount of materials in EOL products reaching waste management systems that could be potentially recovered (taking into account recovery efficiencies of the technologies used for such purpose).

A few definitions are therefore useful, as reported in the box below.

Definition of Basic Recycling Terminology:

Secondary raw materials are defined as '*materials produced from other sources than primary*'.

Recycling rates give '*in time value of the state-of-the-art of the amount of material recovered based on current collection and treatment technology performances*'.

End of life recycling input rate (EOL-RIR) is '*the input of secondary material to the EU from old scrap to the total input of material (primary and secondary)*'. In the EC criticality assessments (EC 2011, 2014), recycling rates and EOL-RIR refer only to **functional recycling**.

Functional recycling is '*the portion of EOL recycling in which the material in a discarded product is separated and sorted to obtain recyclates*'. Recyclates obtained by functional recycling are used for the same functions and applications as when obtained from primary sources. As opposed to recyclates generated from **non-functional recycling** which substitute other raw materials, and therefore do not contribute directly to the total supply of the initial raw material.

Recyclability is '*the potential quantity of a material or product available for recovery at a certain period of time*'. For a material 'a', it refers to the theoretical amount of 'a' potentially recovered once products containing 'a' reach their end of life (EOL).

²³ Please note that the World Governance Indicator (WGI) is expanded by a trade variable, t, which accounts for the influence of trade agreements and export restrictions on the raw material supply risk (see section 3.4 for a detailed discussion of trade).

New scrap refers to *'the scrap generated from processing and manufacturing processes'* and it is also sometimes regarded as pre-consumer scrap. It has a known composition, normally high purity, and origin, and can be often recycled within the processing facility.

Old scrap, also regarded as post-consumer scrap, is *'the amount of material contained in products that have reached their end of life (EOL)'*. It is often mixed with other materials such as plastics or alloys, therefore its recycling requires further detailed processing for proper recovery.

To summarise, although both of these concepts (recycling and recyclability) might seem synonymous to each other, using one concept over the other would significantly affect the assessment and the results of the supply risk determination.

Beyond old and new scrap, as discussed above, also other sources of raw materials could contribute to the EU supply, such as from tailings, spoilings heaps, etc., as briefly discussed in the box below. These are not however considered in the present revision of the EC methodology. They could be further explored in future works.

Further sources of secondary raw materials can also be tailings, spoilings heaps, and waste rock of old mine sites (Bäckström 2012). Re-opening old mining sites for the re-processing of old waste may be one of the environmentally attractive and cost effective remedial options for closed and abandoned mines, and more importantly a potential source of supply of materials to Europe (DHI 2012).

Several EC funded projects include research to identify old mine sites and estimate their reserves, the amount of metal economically feasible to extract and produced. In such context, the "ProMine" project developed the first pan-European GIS-based database containing the known and predicted metalliferous and non-metalliferous resources.

Such research is continued in the "**Minerals4EU/MICA**" project which aims to develop an EU Mineral intelligence network structure delivering a web portal, a European Minerals Yearbook and foresight studies.

The 'Prospecting Secondary raw materials from the Urban Mine and Mining waste (**ProSUM/MICA**)' project is expected to deliver a centralised database, the so-called EU Urban Mine Knowledge Data Platform (EU-UMKDP), which will include all available data and information on arising, stocks, flows and treatment of waste electrical and electronic equipment (WEEE), end-of-life vehicles (ELVs), batteries and mining wastes.

ProSUM will be built on the 'Minerals Intelligence Network' already in place and other ongoing EU funded projects as Minerals4EU, EURARE, and the Knowledge and Innovation Communities on Raw Materials.

Other projects on this area are GeoSeas, EuroGeosource, and OneGeology-Europe.

3.5.4 Role of recycling in previous criticality studies

Several reviews about methods to evaluate raw material supply risk are available (Erdmann and Graedel 2011; Achzet and Helbig 2013). Beyond the EC criticality methodology, in three out of 15 studies available on criticality, recycling is used in the calculation of supply risk (NRC 2008; Erdmann et al. 2011; Graedel et al. 2012), but with a less prominent role in comparison to (EC 2011, 2014), both in terms of visibility and in terms of consequences.

The EC 2010 criticality report states that the more material is recycled in the EU, the lower the supply risk and vice versa. The report also mentions that 'efficient recycling of EOL products and all kinds of production residues at various points in the lifecycle significantly reduces the demand for primary raw materials and thus alleviates the supply risks with which critical raw materials are faced' (EC 2010). In the 2010 criticality methodology, it is implicitly assumed that recycling has no supply risk, though it is referred to as a simplification of the economic reality (EC 2010). Recycling is considered as a riskless possible way to mitigate potential supply risks of primary sources. In 2014, the revised EU criticality report stated that supply risk only applies to primary production as secondary production does not depend on geology. As result within the criticality methodology, recycling is assumed riskless and to reduce overall supply risks (EC 2014).

The use of recycling as "risk-reducing filter" in the calculation of supply risk in EU criticality studies is shown in Figure 14.

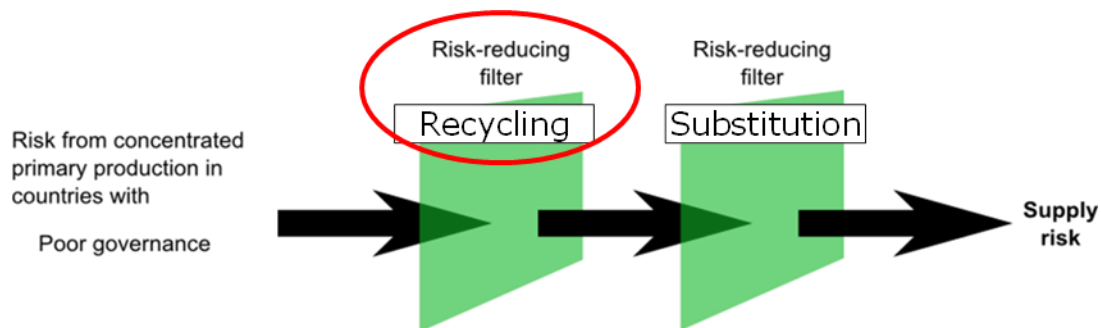

Figure 14 Recycling as a filter mitigating supply risk in the previous EC criticality studies.

3.5.5 Secondary raw materials and recycling in the revised methodology

In the previous EC studies, recycling rates have been 'labelled' differently: recycled content (RC) in the EC 2010 report and end of life recycling input rate (EOL-RIR) in the EC 2014 report. They are however based on the same flows and arrive to the same numerical values. To avoid such confusion, we recommend using the definition on EOL-RIR included in the definitions at the beginning of this section.

In the revised methodology, the role of recycling as a risk-reducing filter of supply risk remains unchanged compared to the previous EC criticality exercises (EC 2011, 2014).

Efforts are focused on using European data readily available for 28 raw materials assessed in the Raw Material System Analysis (MSA) study commissioned by DG GROW (BIO by Deloitte 2015) as well as data from the UNEP report 'Recycling Rates of Metals' (UNEP 2011; Graedel et al. 2011).

Guidance on how to update and improve the quality of EOL-RIR is provided in the next paragraphs.

Changes and confirmations in the revised methodology:

- In the revised EC methodology, the **role of recycling remains unchanged** (i.e, risk-reducing filter).
- **EU based data of higher quality** are to be used
- The revised methodology can be used for both biotics and minerals.

As data sources of EOL-RIR, we propose to following options (**cascade**):

I. Use the Raw Material System Analysis (MSA) data when available to calculate EOL-RIR (section I).

II. When data from the Raw Material System Analysis (MSA) are not available use data from UNEP's report 'recycling rate of metals' (section II).

III. When MSA and UNEP data are not available we recommend using recycling rates from the previous EC criticality reports, or data available from other sources as sectorial reports and expert judgement (section III).

Deviations from I and II and justifications are always to be reported in the RM Factsheet, including the reasoning why the general calculating method does not apply.

Revised RM Factsheets:

Together with the definition of EOL-RIR, we suggest to include a figure illustrating more clearly the system boundaries and flows considered for the calculations. We suggest including a table showing the values of recycling used in the previous and current EC criticality reports to improve the transparency of the recycling rates used to estimate supply risk. In addition, we recommend including in each of the individual raw material factsheet explicit and clear information about recycling metrics and their data sources. Individual material fact sheets included in Annex V of (EC 2010) can serve as a good starting point.

I. Calculation of EOL-RIR using MSA data

The MSA study offers in good detail the input and output flows, and stocks of materials throughout the EU economy. One of the interesting aspects of the MSA data compared to global flow analysis is the inclusion of import and export flows to each of the stages of the life cycle of a material. Including such flows helps understand in which stage and in which form raw materials are entering the EU. One of the findings well-illustrated in the MSA diagrams is that for many materials the extraction and processing stages are mainly located outside Europe. As consequence, many materials enter the EU as intermediates at the manufacture and as end-products at the use stages. For example, over 70% of Beryllium enters as end product at the use stage while the remaining 30% enters as intermediate at the manufacture stage.

MSA studies

In 2012, the European Commission launched the *Study on Data Needs or a Full Raw Materials Flow Analysis* with the objective to support the EC in identifying the information and data needs for a complete raw material flow analysis at the European level. The study focused on information collection for 21 materials or groups of materials from a range of publicly available data bases. In 2015, The study was followed up by the project called *Study on data for a Raw Material System Analysis (MSA)* (BIO by Deloitte 2015). The MSA study aimed to provide a complete overview of existing data sources adapted to material system analysis in Europe, a detailed methodology on establishing MSA in Europe, a complete material system analysis for 28 materials, and recommendations for their maintenance and update. Both projects used the concept of Material System Analysis defined by OECD “as a material specific flow accounts. MSA focuses on selected raw materials or semi-finished goods at various levels of detail and application (e.g. cement, paper, iron and steel, copper, plastics, timber, water) and considers life-cycle-wide inputs and outputs”.

A first step before estimating the EOL-RIR of a raw material is to **define the system boundaries**. The system boundaries can be set up at different life cycle stages (extraction, processing, manufacture, and use) and even to include several life cycle stages (extraction and processing, processing and manufacture, processing, manufacture and use). Recycling rates for a single stage may be useful to understand better the inputs and outputs from/to such stage and identify the most relevant flows. However, since recycling in the EC methodology is seen as contribution to primary supply and therefore to the European industry, **we suggest to define the system boundaries for the productive stages, namely for processing and manufacture for several reasons:**

- The **processing stage is not happening for all materials in the EU**, as result EOL-RIR calculated only taking into account for the processing stage can be zero while still some secondary material can enter manufacture stage.
- **For some materials, the input of primary material is equal or much lower than the input of secondary material**, and therefore the EOL-RIR has very high rates at the processing stage. Figure 15 shows the material flow analysis of tungsten. At the processing stage, the input from primary (2,580 tonnes) and secondary (2,630 tonnes) materials are almost equal. At the manufacture, the input of processed material (10,900 tonnes) is one third higher than the input of secondary material (7,600 tonnes).
- **To be consistent with previous EC criticality studies that excluded ‘new scrap’** as part of the input of secondary materials in the EOL-RIR definition.

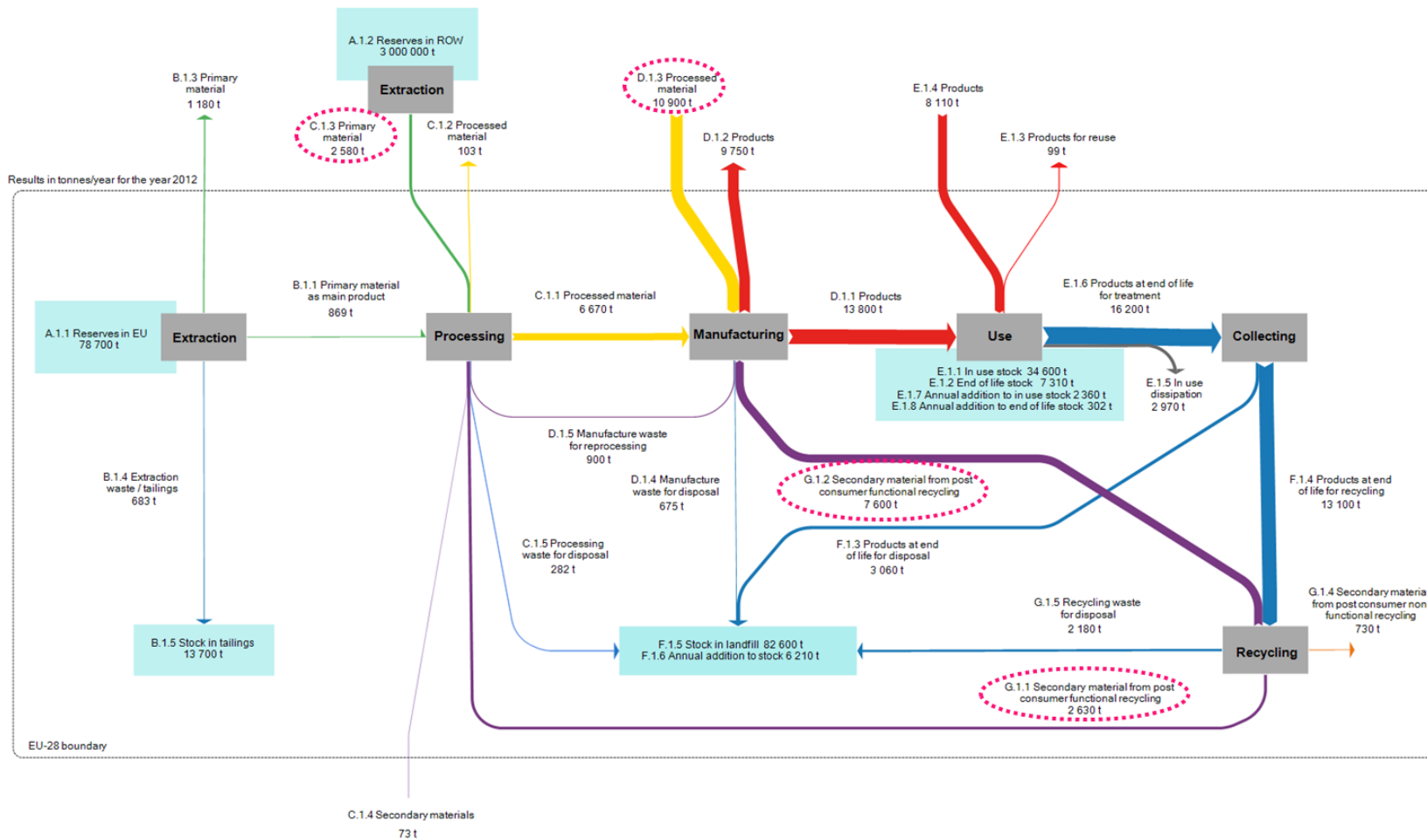

Figure 15 Material system analysis of Tungsten (W) (BIO by Deloitte 2015).

Once the system boundaries are defined, it is also important to discuss which **flows need to be taken into account for the EOL-RIR calculations**.

JRC has explored **four possible options to account for EOL-RIR** using the MSA study. In the following pages, we describe the recommended option with a diagram, and provide the EOL-RIR formula and detail of the flows accounted for. The other three options are reported in **Annex**.

Figure 16 illustrates the life cycle stages of a raw material in Europe and in the rest of the world (ROW). The first part of the figure represents the life cycle stages of a raw material in ROW, while the life cycle stages of a raw material in Europe are represented by the brown boxes. The system boundary is represented in pink dashes. The colour code of the flows is the same as the one used in the MSA study. Flows discussed for the calculation of the EOL-RIR are represented in green (primary material), yellow (processed material), and purple (secondary material).

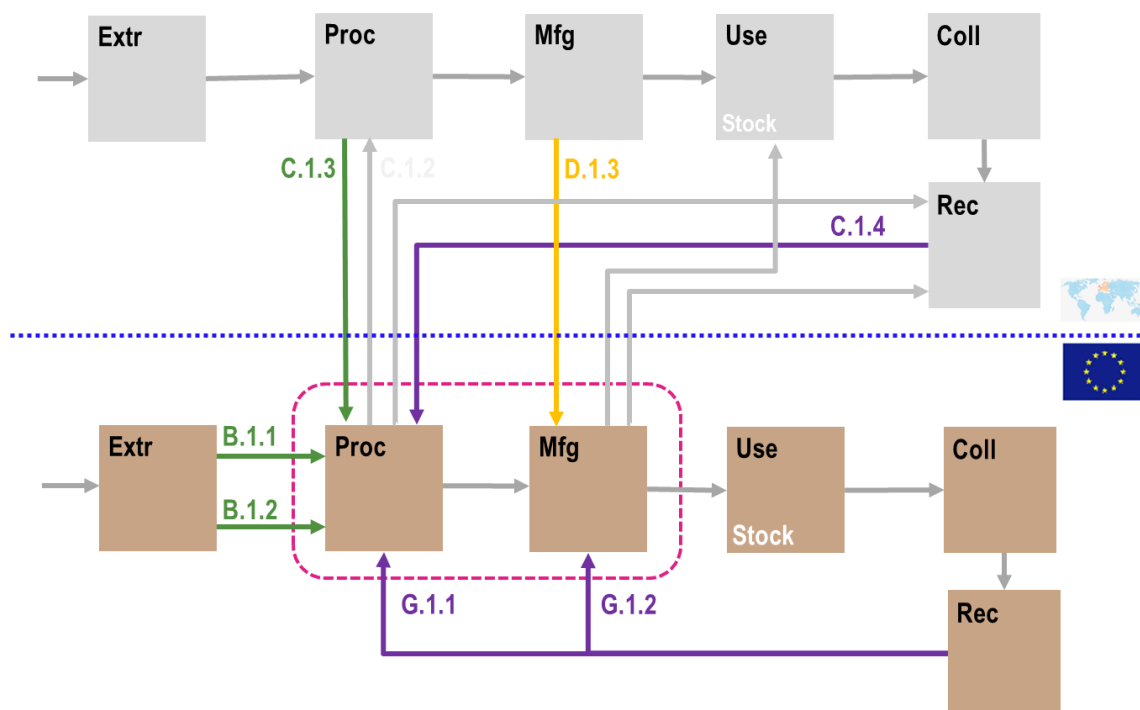

Figure 16 Exemplary material system analysis of a raw material. Flows included in the 'EOL-RIR' calculation are shown in green, yellow, and purple.

In the revised methodology:

JRC recommends using the calculation of EOL-RIR considering the gross import (C.1.3) to processing, because it is better aligned to EU targets including the Raw material policy (i.e., support EU industry's contribution to GDP to 20%). This approach also ensures the comparability with recycling estimates provided in the UNEP report on 'recycling rates of metals' (UNEP 2011).

EOL-RIR is to be calculated by applying the following formula:

$$EOL - RIR_c = \frac{G.1.1 + G.1.2}{B.1.1 + B.1.2 + C.1.3 + D.1.3 + C.1.4 + G.1.1 + G.1.2}$$

Where the MSA flows accounted for are:

- B.1.1.** Production of primary material as main product in EU sent to processing in EU;
- B.1.2.** Production of primary material as by product in EU sent to manufacturing in EU;
- C.1.3** Imports to EU of primary material;
- C.1.4.** Import to the EU of secondary materials;
- D.1.3** Imports to EU of processed material;
- G.1.1** Production of secondary material from post-consumer functional recycling in EU sent to processing in EU;
- G.1.2** Production of secondary material from post-consumer functional recycling in EU sent to manufacture in EU.

An example of use of MSA data for calculating EOL-RIR is reported in Table 12.

Table 12 Example of use of MSA data for calculating EOL-RIR.

Materials	EC report 2014 (EC 2014)	MSA study 2015 (BIO by Deloitte 2015)
Aggregates	Not included	7
Antimony	11	28
Beryllium	19	0
Borate	0	1
Chromium	13	21
Cobalt	16	35

II. Calculation of EOL-RIR using UNEP data

In the report 'recycling rates of metals – a status report' by UNEP, recycling is expressed by three main metrics: old scrap ratio (OSR), recycled content (RC), and end of life recycling rate (EOL-RR) (UNEP 2011). The OSR describes the fraction of old scrap to the overall scrap market, which includes new scrap from manufacturing. The RC is the fraction of secondary metal (old and new scrap) in the total metal input to the total metal production. RC is sometimes also referred to as recycling input rate (RIR). The EOL-RR refers to the amount of old scrap in the product reaching their EOL. It refers to functional recycling only that is "the portion of EOL recycling in which the metal in a discarded product is separated and sorted to obtain recyclates".

Figure 17 illustrates the life cycle stages of one exemplary material. The boxes represent the main stages while the black arrows the flow of metal entering and leaving each stage. Dash arrows indicate losses of metal. The system boundaries used to define each of the recycling metric proposed by UNEP are represented by dashes (pink). The diverse equations to calculate recycling indicators are included inside each of the system boundaries defined.

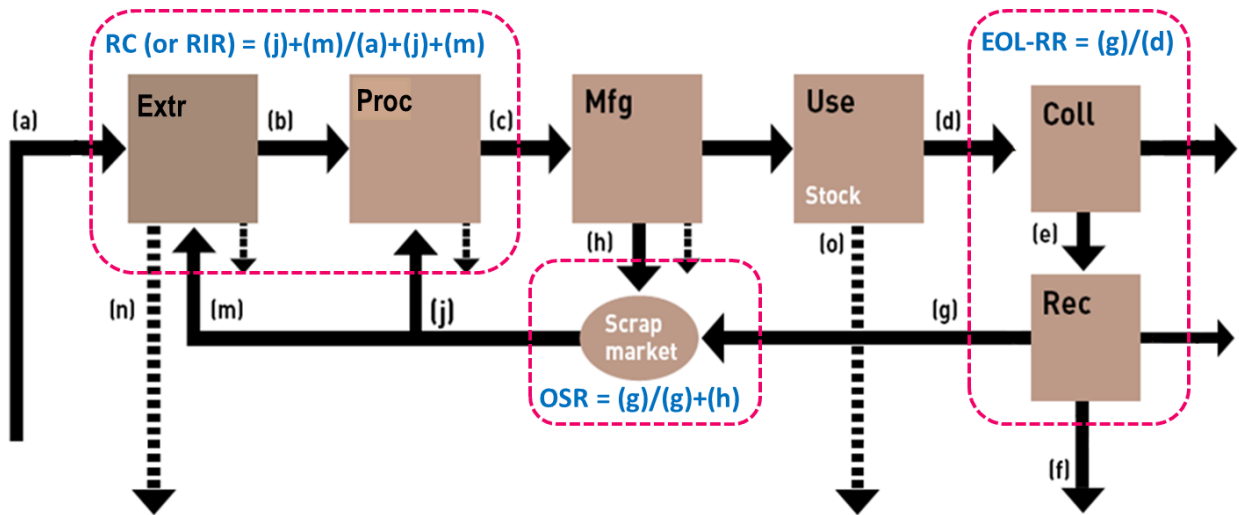

(a): primary metal input; (b): refined metal; (c): intermediate products (e.g. alloys, semis); (d): EOL products (metal content); (e): EOL metal collected for recycling; (f): EOL metal separated for non-functional recycling; (g): recycled EOL metal (old scrap); (h): scrap from manufacturing (new scrap); (j) scrap used in fabrication (new and old scraps); (m): scrap used in production (new and old scrap); (n): tailings and slag; (o): in-use dissipation. **Extr:** Extraction; **Proc:** Processing; **Fab:** Fabrication; **Mfg:** manufacturing; **Coll:** collection; **Rec:** recycling

Figure 17 System boundaries and flows to estimate diverse recycling indicators for a metal life cycle. Modified from (UNEP 2011).

UNEP definitions of old scrap ration (OSR) and recycled content (RC) could be used to estimate the 'end of life recycling input rate' as defined by the EC criticality methodology, this means including only the contribution of old scrap to the total production of a material. 'End of life recycling input rate' values can be deducted from UNEP equations as following:

$$OSR = \frac{\text{Input of secondary material (only old scrap)}}{\text{Total of secondary material (new and old scraps)}} = \frac{(g)}{(g)+(h)} \quad (eq a)$$

$$RC = \frac{\text{Input of secondary material (new and old scraps)}}{\text{Input of primary material} + \text{Input of secondary mat. (new and old scraps)}} = \frac{(j) + (m)}{(j) + (m) + (a)} \quad (eq b)$$

Given the fact that:

$$\text{Secondary material (new and old scrap)} = (g) + (h) = (j) + (m) \quad (eq c)$$

$$EOL - RIR = OSR \times RC = \frac{\text{Input of secondary material (only old scrap)}}{\text{Input of primary mat.} + \text{Input sec.mat. (new and old scraps)}} \quad (eq d)$$

The UNEP report provided several recycling values for OSR and RC estimates, also many times from different data sources. To estimate the end of life recycling input rate (EOL-RIR) at EU level (only considering the contribution from old scrap), we first calculate the average values of UNEP's OSR and RC. Then, we use *equation d* to estimate RC (EU). Table 13 provides some examples of the calculation.

Table 13 End of life recycling input rate (EOL-RIR) calculated using UNEP's figures.

Material	OSR _{av} (%)	RC _{av} (%)	OSR _{av} (%) x RC _{av} (%)
Aluminium	45	35	16
Antimony	45	16	7
Beryllium	45	18	8
Chromium	66	19	13
Cobalt	50	32	16

III. Calculation of EOL-RIR using other sources

When MSA and UNEP data are not available JRC recommends using recycling rates from the previous EC criticality reports, or data available in some scientific and technical publications. For some materials, recycling figures might be available in sectorial reports, or might also be provided by expert judgement. In such cases, a detailed justification about the use of other sources than MSA study and UNEP shall be given. Such justification shall include information about the system boundaries and flows accounted for the EOL-RIR calculations; description about to number of end-uses accounted for; and details about whether EOL-RIR refer to the complete recycling stage or partially to pre-processing and end-processing stages.

Materials not covered by the MSA study and/or the UNEP's report are the following:

<p>Biotic materials: natural rubber, pulpwood, and sawn softwood.</p> <p>Industrial minerals: barytes, bentonite, clays (and kaolin), diatomite, feldspar, gypsum, limestone, perlite, potash, silica sand and talc.</p> <p>Other materials: hafnium, scandium, tellurium, and vanadium, and several rare earths (lanthanum, cerium, praseodymium, samarium, and gadolinium).</p> <p>Please note that some new materials included in the 2015/2016 update may need to be added to this list.</p>

There are several reasons why data for recycling is not readily available. In some cases, the recycling of such materials is not done by selective waste treatment separation and recycling routes. In many cases, materials are not selectively separated for recycling but recycled together with the rest of material where it is contained. This is the case for instance for two biotic materials: natural rubber (contained in tyres), and pulpwood (used in paper). Natural rubber is not selectively separated and recycled from end of life tyres, but recycled as composites. Neither pulpwood is selectively extracted from paper and recycled, but instead recycled together with the paper. In all these cases, developing a more detailed analysis of the materials is needed to understand how recycling can be assessed and quantified.

In some cases, there are some limitations set by nature such as physics, chemistry, metallurgy, and thermodynamics for the functional recycling of the materials. Products reaching recyclers must be separated into suitable fractions to obtain optimal ranges for the recovery of the targeted materials. A big variation in the composition and properties of the processed fraction will affect negatively the recovery yield of materials. Some of the recyclates cannot be used for the same functions or applications and are, therefore, used in other functions. In this case, their recycling does not contribute to a potential

reduction of their supply, but instead reduces the demand of other raw material in new applications and products.

Hereafter, we try to illustrate how other data sources for materials not covered by the MSA study and UNEP report could be used for biotic materials and industrial minerals.

Biotic materials

In the revised methodology three biotic materials were targeted: natural rubber, pulpwood and sawn softwood. The following lines summarises the information available to calculate their EOL-RIR (for more information about biotic materials see section 0).

Natural rubber: About 75% of natural rubber in the EU is used by the tyre industry (Chapman et al. 2013). The European tyre and rubber manufacturer's association (ETRma) published information regarding the amount of used tyres (UT) and their recovery (ETRMA 2011). Such information states that about 34% of all used tyres are recovered however it is not clear if the resulting recycled rubber is used to replace virgin rubber in tyres, and therefore if such rate can be fully attributed to functional recycling. Thus, unless further discussions are engaged with EU tyre and rubber manufacturers association (ETRma), and other related actors, we suggest to use 0% as the EOL-RIR value given in the 2014 EC criticality report.

Pulpwood: Pulpwood is not recycled as originally harvested but in the form of pulp. The fact of recycling pulpwood as one of its intermediates contributes to significant resource savings due to the processing and extracting pulp. The confederation of European paper industries (CEPI) reports that 52% of paper for recycling is supplied to the production of paper and board (CEPI 2015). This estimate matches the EOL-RIR value estimated in the 2014 EC criticality report (51%).

Sawn softwood: Sawnwood has a variety of different end-uses, being the construction its primary driver (80%), and then the furniture sector (20%). There are detailed studies accounting for the recycling of sawn softwood. In 2013, the EOL-RIR used in the criticality assessment was 9%.

Industrial minerals

Recyclates obtained from industrial minerals are frequently used for other functions and applications than the virgin materials originally extracted. The EU Industrial minerals association (IMA) has published a report that includes recycling rates and information about the end-use of the recyclates obtained from some industrial minerals materials (IMA 2013). JRC has elaborated further on such data to quantify the amount of secondary materials effectively substituting virgin primary materials, and therefore contributing to the total supply. The table below summarises the EOL-RIR for some industrial minerals. Detailed information about how the EOL-RIR of industrial minerals is calculated is provided in **Annex 1.2.3**.

Table. Estimates of EOL-RIR given by 2014 EC criticality report and elaborated from IMA 2013 (IMA 2013).

Industrial minerals	EC study 2014	Elaborated from IMA 2013
Bentonite	0	8
Clays (and Kaolin)	0	7
Feldspar	0	32
Limestone	0	26
Silica sand	24	53
Talc	0	32

For industrial minerals not included in the table above (i.e. barytes, diatomite, gypsum, perlite and potash), we suggest to use EOL-RIR given in the 2014 EC criticality report.

3.5.6 Outlook

For future research, we foresee two aspects that could be further considered:

The risk associated to secondary materials

We propose to discuss further if the risk associated to secondary raw materials is to be estimated and whether/how to incorporate it in the criticality assessment. If secondary materials need to be treated equally to primary materials, we foresee two possible options:

Option a) Full integration of primary and secondary raw materials in the Herfindahl-Hirschman Index (HHI) calculation.

$$(HHI_{WGI-t})_{GS} = \sum_C (S_C)^2 \cdot WGI_C \cdot t_C$$

The World Governance Index (WGI) could be used for both primary and secondary sources. The share of country C in the global supply of the raw material considered (S_C) would need data on secondary raw material flows at both international as well as EC level.

Option b) Integrate primary and secondary materials analogously as done in option a, but give a value of zero to the World Governance Index WGI for secondary resources from the EU.

The potential recycling of raw materials

'Potential recycling' or 'recyclability' rates aim to provide a potential estimate of the quantity of materials available at certain period of time. As the amount and number of materials used in products is highly driven by the functionalities that those materials can provide to end-products, a more comprehensive analysis about those functionalities, and how materials are contained in products can help forecast their future potential demand, and therefore the amount possibly available from end-uses and end-products.

An initial indication about the potential recycling of a material can be done using (Ciacci et al. 2015) approach which distinguish each end-use of a material into three categories: 'in-use dissipation', 'currently unrecyclable' and 'potentially recyclable' when discarded. The 'in-use dissipated' refers to the amount of materials scattered and dispersed into the

environment (i.e. sacrificial anodes, fertilizers). The 'currently unrecyclable' stock accounts for material flows into use for which technological and/or economic barriers hinder their recycling (i.e., the recovery of rare earth elements from exhausted glass polishing powders). The 'potentially recyclable' stock gives a theoretical estimate of the amount that could be recoverable using today's treatment and recycling technologies, thus the upper limit up to which the recycling of those materials could be done. The 'Potential recyclable' figures by Ciacci et al. have been calculated globally but they could be analogously calculated for the EU using data from EC criticality studies.

The availability of EOL-RIR and 'potential recycling' would help understand the possible improvements and limitations in current recycling.

3.6 Substitution in SR

Substitution in the context of economic importance and supply risk is discussed in detail in section 2.3 of this report. As discussed in section 2.3, substitution is dependent on factors such as the price and performance of the substitute (EI component) as well as the substitute production, substitute criticality and substitute co-production.

Because existence of available substitutes has the potential to decrease the demand for the candidate material, it can alleviate supply risk inherent in the current supply mix of the candidate material and is therefore **included in the supply risk calculation**. Considerations related to reducing the risk of supply disruptions in the short-term (through readily available substitutes), is important to business within the EU.

Approach to substitution in the revised methodology:

Substitution is dependent on several factors (as summarised below) and interferes essentially both with economic importance and supply risk:

1. Knowledge of existing substitutes (only readily-available substitutes)
2. Technical performance (e.g., very unlikely a tantalum capacitor would be substituted with an aluminium capacitor because a mobile phone would weight 1kg)
3. Cost performance (costs usually drive decisions in business)
4. Substitute production (are substitutes produced in sufficient quantities to be available for newly introduced end-uses?)
5. Substitute criticality (is the proposed substitute already a CRM in the 2014 list?)
6. Substitute by-production (if the proposed substitute is mainly obtained as a by- or co-product, its availability might be at risk).

In the revised methodology elements influencing substitution are subdivided as follows:

- Substitution calculation within EI component (SI_{EI}):

Substitute Cost-Performance (SCP)

- Substitution calculation within SR component (SI_{SR}):

Substitute Production (SP)

Substitute Criticality (SCr)

Substitute Co-Production (SCo)

Please refer to section 2.3 for an explanation on how to incorporate Substitution in the calculation of the supply risk.

4 BIOTIC MATERIALS

4.1 Summary

The chapter discusses the revised methodology for identification of critical raw materials in terms of its suitability for application to biotic raw materials. In contrast to abiotic resources (e.g., minerals and metals), biotic materials are derived from renewable biological sources. We conclude, however, that the revised EU criticality methodology can be also applied to biotic materials. This chapter provides information on data sources that could be used during the assessment, mainly illustrating this for two examples of biotic materials widely used in the EU economy; namely natural rubber and cork. Furthermore, as biotic materials differ from abiotic materials, e.g., due to their renewability, sourcing periodicity and dependence on climatic conditions, land availability and sustainable management of the biotic resource, the criticality methodology (in its current form) may not fully capture all relevant aspects of biotic materials criticality. These could be included in a future update of the methodology or addressed by using slightly different methodologies side by side.

4.1.1 Biotic raw materials in the criticality assessment

The last list of critical raw materials was published in May 2014 (EC 2014), introduced the analysis of 3 biotic raw materials (see the box below for a definition): natural rubber, pulpwood, and sawn softwood.

Biotic raw materials are important for several EU economic sectors, such as: construction, woodworking, furniture, paper, chemical, automotive, and pharmaceutical. Even though they are renewable, their supply is also affected by several constraints that can lead to shortages in the EU. These concerns resulted in the inclusion of these three biotic materials in the 2014 criticality report.

Definition:

Biotic raw materials are “*materials which are derived from renewable biological resources*”, meaning that these materials “*are of organic origin but not of fossil origin*” (Chapman et al, 2013).

Biotic raw materials are, e.g., natural rubber, wood, cork, fibrous materials (rattan, hemp, flax, etc.) sugar, starch, and vegetable oils. The critical raw material list is focused on non-food and non-energy materials. Therefore, material end-uses such as burning wood for energy recovery and biofuels production from vegetable oils were excluded as candidates for the list of critical raw materials.

In addition to the 2010 and 2013 EU criticality studies, several Member States published their own analyses on raw material issues, e.g., Germany (IW Consult 2011), the Netherlands spices (Dutch Ministry of Agriculture 2009; Dutch Ministry of Foreign Affairs 2013; IDH 2015), and the UK (BGS 2012).

In 2008, the Netherlands assessed its needs for biotic raw materials, for all the uses including agriculture, food, energy and chemicals. This assessment was performed based on two criteria, namely “*importance of the material for the Dutch economy*” and “*sustainability*”, and was done in the framework of the “*biodiversity policy programme and sustainable trade initiative*”. From this assessment the following biotic materials

were identified as important: soya, palm oil, fish (meal), peat, cocoa, coffee, and spices (Dutch Ministry of Agriculture 2009; Dutch Ministry of Foreign Affairs 2013; IDH 2015).

The United Kingdom published a “*Review on the future resource risk faced by UK business and an assessment of future viability*” (UK Department for Environment 2010) which included also biotic resources, considering their uses in different sectors (food, feed, and chemicals). In this study, wood, palm oil (used in food and cosmetics) and fish (used in food) were identified as key biotic resources to the UK business. In their work a scoring methodology was used for prioritisation of resources, considering criteria such as: consumption/production, scarcity/availability, available alternative, supply distribution (or concentration of supply), geopolitical influences, press coverage (to measure public concerns related to the resource), and price fluctuations. The same study also includes an assessment of the resource risk impacts on the different economic sectors (using four scenarios of supply and demand).

The described approaches are different from the EU criticality studies, both with respect to methodological considerations and the broadness of the scope (the EU approach only looks at non-food and non-energy raw materials, while the other studies consider also the food sector). However, all studies agree on the importance of identifying those raw materials of particularly importance in the sense that a disruption of their supply may significantly damage the economy.

4.1.2 Why are biotic raw materials important?

The importance of biotic resources for the EU economy has been underlined by several EU legislation frameworks in particular the EC communication “*Innovating for Sustainable Growth: A Bioeconomy for Europe*” COM(2012)60 (EC 2012), highlighted that the development of a strong bio-based economy will support the creation of jobs and sustainable growth.

Biotic materials are used in several non-food and non-energy sectors, such as: construction (wood material, isolations materials), woodworking, furniture, pulp and paper, chemical, transport (tyres), pharmaceutical, and cosmetic industry. They can be used as sustainable substitutes for fossil-based materials (e.g., bio-polymers and other bio-based chemicals) contributing to decrease the dependence on fossil materials and greenhouse gas emissions.

The European Chemical Industry Council - CEFIC (CEFIC 2014) estimates a share of 9% of biotic materials (about 8 million MT per year) used as feedstock in the EU chemical industry. The identified materials include: vegetable oils, animal fats, pulp wood, starch and sugar, bioethanol, natural rubber, glycerol, and others. Vegetable oils, starch/sugar and natural rubber are the most used biotic feedstock, with 18 to 14% share of the biotic materials consumption in the EU chemical industry.

Natural rubber is mainly used in the production of tyres, which are responsible for about 75% of total EU natural rubber consumption. The remaining 25% is used for tubing, footwear, construction materials and food contact materials. The members of the European Tyre & Rubber Manufacturers Association (ETRMA) produced 4.67 million tonnes of tyres in 2013, accounting for 20% of the world tyre production, which represents an important market for the EU.

According with the EU projections of (Mantau 2015), about 460 million m³ of wood were consumed in 2010 for the production of building materials (ranging from sawn wood to wood-based panels) and pulp and paper.

Therefore, biotic materials are used in a variety of important markets some of them already well-established in Europe, such as the woodworking and furniture industries, tyres and paper, as well as others in big expansion such as organic acids and biopolymers.

4.1.3 Why are biotic raw materials different from abiotic?

It is important to highlight that biotic materials are substantially different from abiotic materials, especially in that their supply is subject to several constrains not affecting abiotic materials. These, however, are not well reflected in the criticality methodology. The supply of biotic materials is seasonal and can be dramatically affected by:

1. Land availability;
2. Sustainable management of the biotic resources;
3. Competition with other end uses (bioenergy, food and feed);
4. Climatic conditions, natural disasters and fires;
5. Biological threats (pests, parasites, insects, etc.).

Several of these aspects and their effect on biotic risk of supply are discussed in detail in section 5 on Additional Influences.

Apart from the above commonalities, there is also a high degree of heterogeneity both between and within biotic materials.

4.2 Assessment of the suitability of the refined methodology for biotic materials

The authors of (Chapman et al. 2013) the EU criticality study applied the CRM methodology to three biotic materials, namely natural rubber, pulpwood, and sawn softwood. The methodological approach followed for the calculation of the economic importance and the supply risk was robust enough for application to biotic raw materials.

Among the analysed materials, natural rubber was the most "critical" biotic material. Natural rubber scored above the economic importance threshold of 5 (score of 7.73) but below the threshold of 1 for the supply risk (score of 0.9). The high economic importance found for natural rubber can be explained through its wide use in tyres, which was associated with the Megasector "road transport" i.e., one of the most important megasectors in the EU²⁴. During the calculation of economic importance only the application of natural rubber in tyres was considered due to a lack of data. However, as stated by the authors, the use of natural rubber in tyres represents only 75% of the EU consumption of this raw material. Therefore, a quarter of the overall use of natural

²⁴With a Gross Value Added (GVA) of 147,406 €M for Road Transport, only the megasectors for Food, Metals, and Mechanical Equipment have higher GVAs

rubber was not accounted for. For the supply risk metric, (Chapman et al. 2013) reported a moderate concentration of production, since over 10 countries worldwide produce natural rubber (mainly South East Asian countries). A zero recyclability rate of natural rubber was considered for the calculation of the supply risk because, according to the authors, a closed-loop recyclability of tyres is not technically feasible. Finally, the authors stated that, for the moment, there are no substitutes for natural rubber in tyres that can deliver the same performance characteristics. Therefore, an overall substitution index of 0.83 was introduced in the calculation (considering few applications where natural rubber can be substituted).

For pulpwood and sawn softwood the authors highlight that it was more difficult to do a full comparison with the abiotic materials because for these materials the EU is not dependent on imports. Pulpwood scored 2.25 on economic importance and very low on the supply risk (0.12). Regarding economic importance pulpwood is mainly used in EU for paper production and the paper megasector has one of the lowest GVA (41,276 €M). For supply risk, pulpwood production is spread all over the world and therefore the country production concentration is low. Additionally, in the EU paper has a high recycling rate (51% was used in the 2013 study for the supply risk calculation, this corresponds to the percentage of paper for recycling that is supplied to the production of paper and board (CEPI 2015), decreasing in this way the amount of raw material need). A 0.7 substitution index was given to pulpwood for all the end-uses, due to the possible substitution of paper by electronic alternatives.

For sawn softwood, the authors calculated a score of 5.27 for the economic importance (slightly above the threshold 5). Similar to pulpwood, sawn softwood scored very low in the supply risk assessment (0.15). The high economic importance is a consequence of the high GVA of the construction megasector (104,441 €M), which is the main end use of sawn softwood. Regarding the supply risk, similar to pulpwood, quite a number of countries in the world are producers of sawn softwood.

The authors highlighted that one of the main difficulties of the analyses of criticality for biotic materials was the poor data quality and availability, especially regarding end uses of natural rubber.

In the next sections each of the components of the revised methodology (described in sections 2 (economic importance) and 3 (supply risk) are discussed in terms of their applicability for the assessment of the criticality of biotic materials. Information on data sources that could be used during the assessment are also provided, mainly for two biotic exemplary cases: natural rubber and cork. It is important to highlight that all the considered materials are mainly harvested from forests or other wooded land (following the definitions of the Food and Agriculture Organization of the United Nations, (FAO 2010a)). Other sources of biotic materials are agriculture crops, e.g., cotton and trees outside the forest.

4.2.1 Natural rubber: background information

Natural rubber is mainly harvested (rubber tapping) from the rubber tree *Hevea brasiliensis* in the form of latex (a white emulsion). Other species can also be sources of latex but their use is not as straightforward as *Hevea brasiliensis*.

Natural rubber is extracted by making a cut in the rubber tree bark. The natural rubber can start to be harvested when the tree achieves at least 45 cm in circumference which corresponds to a tree age of about 6 years and it can last until the tree reaches around 30 years. After this period the tree can be harvested to provide wood for furniture and other applications.

Hevea brasiliensis is a native species of the Amazon region but it has been introduced into several other regions for rubber production. At the moment Southeast Asian countries are the bigger producers of natural rubber.

(Chapman et al. 2013) considered a limited number of natural rubber applications, covering about 75% of the consumed natural rubber. In addition to its use in tyres, natural rubber can also be used in: tubing, foot wear, construction materials, and food contact materials. However, very little data seem to be available on natural rubber consumption, recyclability, and substitutability for each of these applications (only one study was found with information on Malaysian consumption (MYS 2014)). Information on total consumption of natural rubber within the EU is available in the ETRMA statistics (ETRMA 2014). Data on the distribution of natural rubber through the different end uses is difficult to find. The International Rubber Study Group provides estimates of the world application shares of natural rubber (see Figure 18), but not on the EU level.

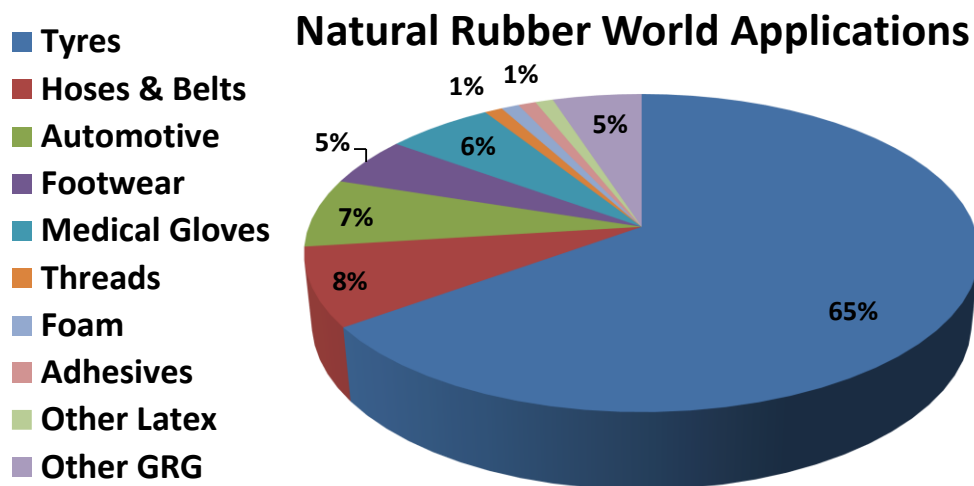

Figure 18 Distribution of the world natural rubber applications. Estimates from the International Rubber Study Group.

Additional sources of statistical information on natural rubber include:

- FAOSTAT with information on trade, production and harvested areas of natural rubber (FAOSTAT 2015). <http://faostat3.fao.org/search/rubber/E>;
- International Rubber Study Group, (IRSG 2015) has several reports on the rubber industry. <http://www.rubberstudy.com/statistics.aspx>. Their Rubber Statistical Bulletins have information on global natural rubber: production, consumption, exports, distribution of consumption by sector and cultivation areas. In the latest data sources, it is possible to detect shifts of land occupations between rubber plantations to palm oil plantations in Malaysia.
- Figure 19 provides information on the evolution of natural rubber harvesting areas. It is possible to see that in Malaysia the area harvested for cultivation of natural rubber decreased in the last decade, while for other countries this area increased, resulting in a net increase of the global harvested area.

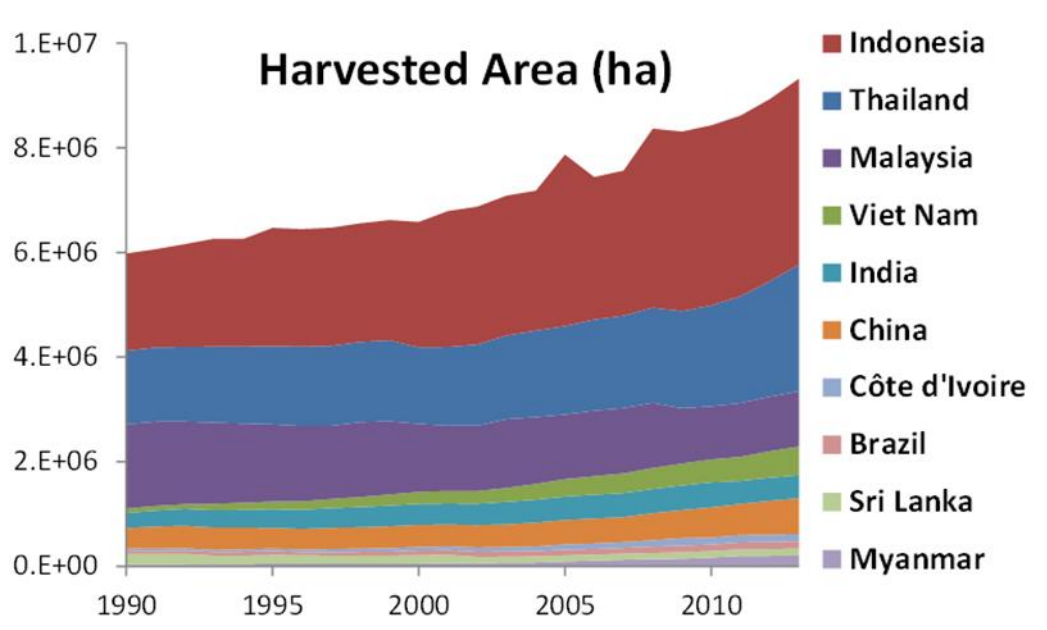

Figure 19 Natural rubber harvested are, data from FAOSTAT.

According with the refined methodology described in section 3.2 the share of EU imports of the analysed materials should be taken into account in the calculation of the supply risk. From the biotic materials under consideration, natural rubber is completely dependent on imports. Therefore, natural rubber was chosen as an example to test the inclusion of the EU imports share in the methodology.

Table 14 shows the distribution of natural rubber imports to the EU for the supplying countries. Data of imports were collected from EUROSTAT (EUROSTAT 2015), while data from production were collected from (Chapman et al. 2013). For the EU imports, figures include the following product categories: (1) natural rubber latex, whether or not pre-vulcanised; (2) smoked sheets of natural rubber; (3) technically specified natural rubber (tsnr); (4) other natural rubber. The 2012 ETRMA statistics report also reported information on natural rubber EU imports from 2007 to 2011 (ETRMA 2012).

Table 14 Comparison of the world natural rubber production distribution and the EU import shares

Country	Production (kton)		EU Imports (kton)					
	2012*	Share	2012	Share	2013	Share	2014	Share
THAILAND	3,512	30.8%	185	16.6%	184	16.1%	207	17.3%
INDONESIA	3,015	26.5%	349	31.2%	383	33.5%	406	33.8%
VIETNAM	955	8.4%	70	6.2%	71	6.3%	78	6.5%
MALAYSIA	923	8.1%	228	20.4%	200	17.5%	187	15.5%
INDIA	915	8.0%	5	0.4%	3	0.2%	4	0.3%
CHINA	795	7.0%	3	0.3%	0	0.0%	1	0.1%
COTE D'IVOIRE	255	2.2%	144	12.9%	154	13.5%	127	10.5%
BRAZIL	171	1.5%	0	0.0%	0	0.0%	0	0.0%
SRI LANKA	150	1.3%	5	0.5%	4	0.4%	5	0.4%
MYANMAR	136	1.2%	0	0.0%	0	0.0%	0	0.0%
PHILIPPINES	111	1.0%	0	0.0%	0	0.0%	0	0.0%
Rest of World	451	4.0%	129	11.5%	143	12.5%	186	15.5%
Total	11,389	100.0%	1,120	100.0%	1,145	100.0%	1,202	100.0%

*Data from the 2013 contractor's report.

Table 14 shows that even if Thailand is the main producer of natural rubber, it is only the 3rd (in 2012) or 2nd (in 2014) country in the share of EU imports of natural rubber. Indonesia has the main share of EU imports and Malaysia has also an important contribution to the imports, while its production represented only 8% of the world production.

4.2.2 Cork: background information

Cork is used in a wide variety of applications, including the beverages industry (e.g., stoppers for wine bottles), apparel, in several construction materials and in automotive applications. Its world production is concentrated in Portugal (more than 50% of the production share) and Spain (c. 30 %). The main applications of prime, natural cork is to produce wine stoppers and construction materials. However, nowadays cork is also used – most often in its agglomerated and/or expanded form - to produce: footwear, protective equipment, corkboards, bags, clothing, sport equipment and is widely used as a construction material for insulation (thermal, acoustic and vibration), flooring, counting, and decoration as well as in the automotive industry.

Cork is a material that is harvested from the external tissue (outer bark) of the Cork Oak (*Quercus suber*) which occurs naturally in several Mediterranean countries. Cork Oaks can live on average 150-200 years and cork can be harvested for the first time when the tree reaches at least 70 cm of diameter at breast height and an age of around 22 years. After that, cork can be sourced every nine years from the upper limbs of the trees and the tree cannot be completely harvested because this would affect the survival of the tree. The first three harvests give a quality of cork that cannot be used to produce stoppers due to its hardness and inelasticity.

The Cork Oak forests provide several environmental and social benefits: (1) biodiversity protection, supporting up to 135 different plant species per square metre and a rich diversity of fauna (WWF 2015); (2) prevention against soil erosion; (3) they are natural barriers against fires; (4) and regulation of soil hydrological cycle; (5) they are also providers of a high variety of food and other non-wood products.

Cork Oak forests can be affected by poor management and over-exploitation of the forest resources which leads to an impoverished supply (quantity and quality). Against a back-drop of increased global wine production and consumption, especially for high-quality, New World wines, substitutes for wine stoppers (plastic stoppers, metal and glass) have taken significant market share. As a result, income from cork is reduced, which in turn can decrease investments on oak forests leading to their further degradation (FAO 2010b and DG GROW). Further details on this treats are described as an example in section 5.2.3.2.2 (Economic land use competition for biotic materials).

From the data collected form Associação Portuguesa da Cortiça (APCOR 2015a) the consumption of cork is divided as shown in Figure 20 (in terms of Portuguese cork volume sales).

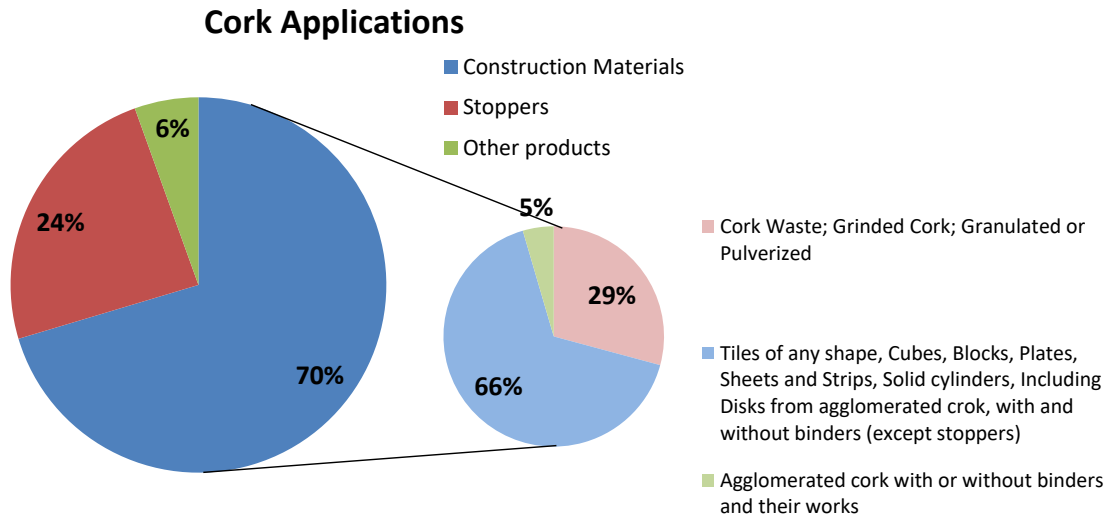

Figure 20 Distribution of cork applications from Portuguese sales, in terms of volume. Source: (APCOR 2015a).

This figure represents the distribution of the end uses of the cork produced in Portugal. More accurate distribution should be calculated if information is available for the cork applications within the EU.

The annual cork production and cork oak cultivation areas are shown in Table 15 (data from 2010, (APCOR 2014)). The figure shows that the majority of producing countries are located within the EU. The EU is a net exporter of cork, exporting to countries such as the United States, Russia Argentina and China.

Table 15 Annual production and calculation area by producing country.

Country	Average annual production		Cultivation area	
	2010 (in ton)	Share (%)	2010 (in ha)	Share (%)
Portugal	100,000	49.6	715,000	33.7
Spain	61,504	30.5	574,248	27.1
Morocco	11,686	5.8	383,120	18.1
Algeria	9,915	4.9	230,000	10.9
Tunisia	6,962	3.5	85,771	4.1
Italy	6,161	3.1	64,228	3.0
France	5,200	2.6	64,800	3.1
Total	201,428	100	2,117,167	100

4.2.3 Step by step discussion on the suitability of the refined methodology for biotic materials

The proposed methodology is general enough to be used also in the assessment of criticality of biotic materials. Concerns on data availability exist and may complicate the assessment, especially of the recycling and substitution parameters. The next sections will discuss in detail the applicability of the refined criticality methodology as discussed in section 2 and 3 to biotic materials

(1) Allocation of the biotic material end uses to the industrial sectors and calculation of their value added using NACE Rev. 2

As described before, good quality data for all biotic material end uses may be difficult to find. For example, for the majority of natural rubber applications there is no clear distinction between uses of natural or synthetic rubber in the statistical databases. However, the information available on the main uses is enough to calculate the economic importance using the proposed approach for NACE Rev. 2 (see section 2.2). Therefore, no changes will be needed for the calculation of the biotic materials economic importance.

For **natural rubber** considering the main use in tyres manufacturing this corresponds to the industrial sector of "Manufacture of rubber and plastic products" with NACE Rev. 2 code 22 and a gross value added of 82 000 million Euros in 2013. Additionally, the majority of the other uses described in Figure 18 are also within industrial sector 22 (see Table 16).

For **cork** the majority of use applications (Figure 20) fall within the industrial sector of "Manufacture of wood and of products of wood and cork, except furniture; manufacture of articles of straw and plaiting materials" which has the NACE Rev. 2 code 16 and a gross value added of 29 584.8 million Euros in 2013 (see also Table 17).

Table 16 Allocation of natural rubber end uses to correspondent sectors and CPA categories.

Natural Rubber			
End use	2-digit NACE Rev. 2 sector	Detailed NACE Rev. 2 sector (3- and 4-digit)	CPA categories
Tyres	22 - Manufacture of rubber and plastic products	22.11 - Manufacture of rubber tyres and tubes; retreading and rebuilding of rubber tyres	22.11.11 - New pneumatic tyres, of rubber, of a kind used on motor cars; 22.11.12 - New pneumatic tyres, of rubber, of a kind used on motorcycles or bicycles; 22.11.13 - New pneumatic tyres, of rubber, of a kind used on buses, lorries or aircraft; 22.11.14 - Agrarian tyres; other new pneumatic tyres, of rubber
Other rubber goods	22 - Manufacture of rubber and plastic products; 15 -	22.19 - Manufacture of other rubber products	22.19.30 - Tubes, pipes and hoses, of vulcanised rubber other than hard rubber; 22.19.40 - Conveyor or transmission belts or belting, of vulcanised rubber; 22.19.50 - Rubberised textile fabrics, except tyre cord fabric; 22.19.60 - Articles of apparel and clothing accessories, of vulcanised rubber other than hard rubber; 22.19.71 - Hygienic or pharmaceutical articles (including teats), of vulcanised rubber other than hard rubber; 22.19.72 - Floor coverings and mats, of vulcanised rubber other than cellular.
	15 -	15.20 -	15.20.11 - Waterproof footwear, with outer soles

	Manufacture of leather and related products	Manufacture of footwear	and uppers of rubber or plastics, other than footwear incorporating a protective metal toe-cap; 15.20.12 - Footwear with outer soles and uppers of rubber or plastics, other than waterproof or sports footwear; 15.20.13 - Footwear with uppers of leather, other than sports footwear, footwear incorporating a protective metal toe-cap and miscellaneous special footwear; 15.20.14 - Footwear with uppers of textile materials, other than sports footwear; 15.20.21 - Tennis shoes, basketball shoes, gym shoes, training shoes and the like.
--	---	-------------------------	---

Table 17 Allocation of cork end uses to correspondent sectors and CPA categories.

Cork			
End use	2-digit NACE Rev. 2 sector	Detailed NACE Rev. 2 sector (3- and 4-digit)	CPA categories
Construction materials, stoppers and other uses	16 - Manufacture of wood and of products of wood and cork, except furniture; manufacture of articles of straw and plaiting materials	16.29 - Manufacture of other products of wood; manufacture of articles of cork, straw and plaiting materials	16.29.22 - Articles of natural cork; 16.29.23 - Blocks, plates, sheets and strips, tiles of any shape, solid cylinders, of agglomerated cork; 16.29.24 - Agglomerated cork; articles of agglomerated cork n.e.c.
	15 - Manufacture of leather and related products	15.20 - Manufacture of footwear	15.20.13 - Footwear with uppers of leather, other than sports footwear, footwear incorporating a protective metal toe-cap and miscellaneous special footwear.

(2) Substitution

As described before (section 2.3) the revised methodology includes substitution both in the economic importance and supply risk components. This calculation relies on the identification of substitutes for the end uses of biotic materials. The same methodology described in section 2.3 can be applied to account for substitution of biotic materials.

For the case of natural rubber the main potential substitute is synthetic rubber, however for several applications, such as tyres (excepted for several 2-wheel vehicles), it is difficult to completely substitute natural rubber (ETRMMA 2014), because synthetic rubber doesn't have equal performance characteristics, such as good shear resistance.

For cork and its application in wine stoppers the main substitute is plastic (for plastic stoppers - made from polyethylene) but also aluminium and glass. The performance and costs of this materials vary but plastic stoppers typically known as synthetic stoppers are

considered to be good alternatives to cork with similar performance, except for long aging of wines (up to 20 years) (APCOR 2015b). According to (Silva et al. 2011) synthetic stoppers have typically high rates of oxygen transfer and are recommended for wines consumed within less than 2 years after bottling. Less oxygen permeable stoppers are screw caps and technical cork stoppers followed by natural cork stoppers.

(3) Import dependency in the calculation of the supply risk

In the 2013 criticality report (Chapman et al. 2013), the Herfindahl-Hirschmann-index (HHI) was used to account for country concentration of supply when calculating the supply risk. For all the biotic materials, country concentration was calculated considering the raw material production distribution in the world, which represents the global supply mix of the raw materials. The new proposed methodology accounts also for the distribution of raw material supply to the EU (EU supply mix), by calculating a weighted average of both global supply risk and imports supply risk (see section 3.2).

This improvement can easily be applicable to biotic materials, influencing mainly materials that are highly dependent on imports from outside the EU. For this reason this improvement was tested for natural rubber since it is a biotic material highly dependent on imports. Data from production was collected from the 2013 criticality report (Chapman et al. 2013) (figures from 2012) and data from imports were collected from (EUROSTAT 2015).

The results presented in Figure 21 shows that a lower concentration of supply to the EU (mainly four countries supply natural rubber to the EU) when compared with the global supply (mainly 2 countries supply natural rubber).The import reliance for natural rubber was assumed to be 100% since the EU is completely dependent on imports from outside the EU.

Regarding Cork, the EU is a net exporter. Therefore, the supply risk of cork should not be affected by import dependence.

NATURAL RUBBER - GLOBAL SUPPLIER COUNTRIES
(~11.4 Mt in 2012)

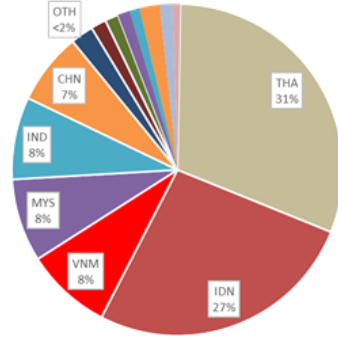

NATURAL RUBBER - ACTUAL SUPPLIERS TO EU28
(~1.1 Mt in 2012 EUROSTAT)

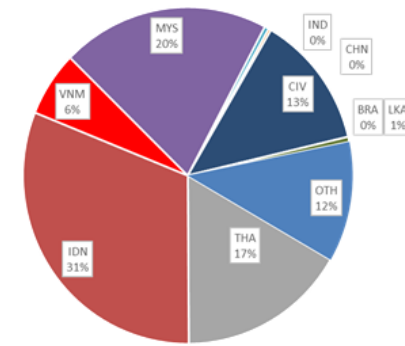

Material	Country name	Country Code	WGI Scaled	% of global supply
Natural rubber	Thailand	THA	5.58	31%
Natural rubber	Indonesia	IDN	5.94	26%
Natural rubber	Vietnam	VNM	6.1	8%
Natural rubber	Malaysia	MYS	4.36	8%
Natural rubber	India	IND	5.6	8%
Natural rubber	China	CHN	6.18	7%
Natural rubber	Côte d'Ivoire	CIV	7.32	2%
Natural rubber	Brazil	BRA	4.74	2%
Natural rubber	Sri Lanka	LKA	5.58	1%
Natural rubber	Myanmar	MMR	8.3	1%
Natural rubber	Philippines	PHL	5.98	1%
Natural rubber	Other Africa	OTH	0	2%
Natural rubber	Other Latin America	OTH	0	1%
Natural rubber	Other Asia/Pacific	OTH	0	1%
Total				100%

Country Code	WGI Scaled	% import to EU	% of actual supply to EU28
THA	5.58	16.6%	16.6%
IDN	5.94	31.2%	31.2%
VNM	6.1	6.2%	6.2%
MYS	4.36	20.4%	20.4%
IND	5.6	0.4%	0.4%
CHN	6.18	0.3%	0.3%
CIV	7.32	12.9%	12.9%
BRA	4.74	0.0%	0.0%
LKA	5.58	0.5%	0.5%
MMR	8.3	0.0%	0.0%
PHL	5.98	0.0%	0.0%
OTH	0		
OTH	0	11.5%	11.5%
OTH	0		
Total			100%

Figure 21 Distribution of natural rubber production (global supply) (left). Distribution of natural rubber suppliers to EU (right).

(4) Export restrictions and international trade agreements in the calculation of the supply risk

The procedure described in section 3.4 to take into account export restrictions and trade agreements in the calculation of supply risk can be applied to biotic materials following the two data sources suggested: (1) For export restrictions: OECD's Inventory of Restrictions on Exports of Raw Materials and (2) For EU bilateral trade agreement: DG Trade, Overview of trade agreements.

As already mentioned in section 3.4, in the OECD's inventory several restriction to imports can be found for biotic materials, such as: industrial roundwood coniferous; industrial roundwood non-coniferous; sawnwood non-coniferous non-tropical; sawnwood coniferous; sawnwood non-coniferous tropical; sawnwood non-coniferous non-tropical. No export restrictions are mentioned in the OECD's inventory for natural rubber and cork from the supplying countries, other sources of information should be explored if restrictions are known to exist.

Regarding trade agreements, the same procedure described in section 3.4 is also applicable for biotic materials.

(5) Recycling ratio in the calculation of the supply risk

In terms of recycling, biotics are different from the majority of the abiotic materials, for the majority of the cases the recovered biotic "old scrap" can't be re-used in the same application or with the same properties as the original raw material. This is the case of recycling of end-of-life tyres, where natural rubber is recovered together with the other materials in the tyres. These recovered end-of-life tyres are then usually used for example in flooring applications. For the case of cork used in stoppers it cannot be used again for producing beverages stoppers, they are typically used as agglomerates in a variety of applications from insulation and flooring to craft materials. Therefore, for biotic materials it is important to identify the cases where the recycling decreases the demand of the materials for the targeted application, in order to calculate the recycling ratio in the supply risk. A detailed analysis of biotic material recycling is provided in section 3.5 on recycling.

4.3 Confirmations / novelties in the revised methodology (biotics)

All the refinements proposed in the revised methodology are flexible enough to be applied to all raw materials including biotic materials. However, biotic materials are different from abiotic ones, and to highlight this difference JRC proposes to include in the RM fact sheets information on aspects that influence the supply risk of biotic materials (also discussed in section 5). At the same time JRC also proposes future improvements to the methodology (see boxes below). The analysis conducted in section 4 provides also information on data sources that could be used during the assessment, mainly for two examples of biotic materials widely used in the EU economy, namely natural rubber and cork.

In the revised methodology:

The revised methodology can be used to assess the criticality of biotic materials.

In the RM fact sheets:

It is important to highlight that biotic materials are, in several aspects, different from abiotic materials and their supply is affected by factors not reflected in the present criticality methodology. These are further discussed in section 5 on additional influences. ***It is recommended to include information on these additional influences in the materials fact sheets.***

Possible future improvements: If specific aspects related to biotic materials supply risk (e.g., degradation of cork oak ecosystems or the risks that are evaluated in section 5) shall be addressed in the calculation of the criticality, a solution could be to analyse the criticality of biotic materials separately from abiotic ones, using the same methodology, but incorporating a few additional influences to supply risk that are specific for biotic materials. This could be done by creating a separated list for critical biotic materials that included in the assessment additional factors related only with the supply risk of biotic materials. This could be an important improvement recognising the differences between the two groups (biotic and abiotics). These differences include, e.g., renewability, sourcing periodicity and dependence on climatic conditions, land availability and sustainable management of the biotic resource, etc. It should also be taken into account that there is a high degree of heterogeneity both between and within biotic materials and thus methodology may need to be continuously adapted and refined as new materials are considered.

5 ADDITIONAL INFLUENCES

5.1 Summary

This chapter discusses the role of five additional influences for the supply risk of abiotic and biotic materials. These are part of a larger group of eight additional influences described in the 2013 Study on Critical Raw Materials at EU Level (Chapman et al. 2013), as shown in the upper part of Figure 22.

The JRC work and subsequent discussion with DG GROW and stakeholders led to the conclusion that the same revised methodology can be used for both minerals and biotics, at least for the upcoming revision of the list of critical raw materials. Integration of additional influences relevant to both minerals and biotics seems highly recommended. A proposal for such integration is shown in the lower part of Figure 22, where also the relevance of each additional influence to both minerals and biotics is indicated by life cycle stage. Environmental and social issues are relevant across the full raw materials life cycle.

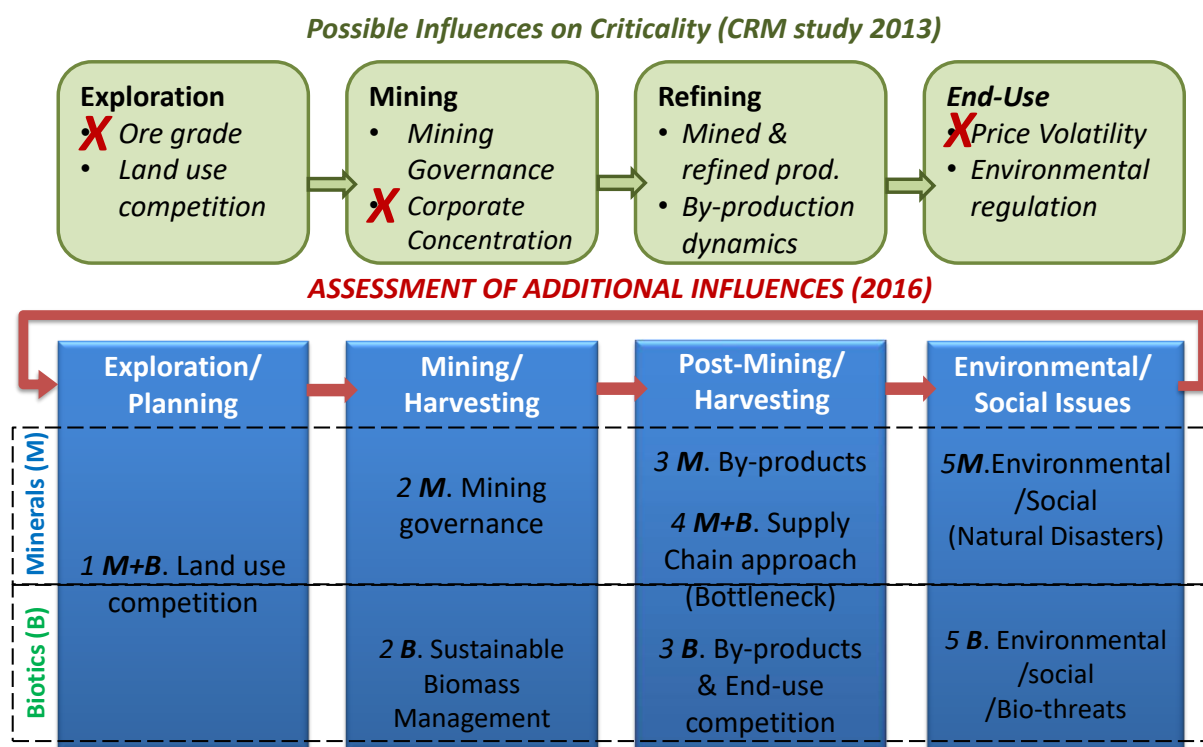

Figure 22 Additional influences to the supply risk of abiotic and biotic materials. M: Minerals. B: Biotics. (X = excluded)

The five additional influences discussed are (Figure 22): (1) land use competition (minerals and biotics), (2) mining governance (minerals) and sustainable sourcing of biotic materials, (3) by-production dynamics (minerals) and end-use competition (biotics), (4) supply chain approach (minerals and biotics), and (5) environmental and social considerations (minerals) and natural disasters (biotics). The importance and relevance of these influences to the supply risk are discussed and ways to integrate them into the criticality calculation are presented.

Two additional influences are integrated into the revised methodology and reflected in the equations: **Mining governance** and **Supply chain approach**, as described in sections 3.2 and 3.3, respectively.

In view of the next revision of the CRMs list, some of the other influences are to be better reflected in the factsheets and/or the JRC put forward concrete proposals for future developments.

Additional influences may be of high relevance if they bring in risk factors that are not well captured in the existing calculation. A key element in analysing the relevance of additional influences in terms of supply risk is differentiating between their role as supply risk factor as such, and/or having an important role when responding to, or anticipating, supply disruptions (resilience). An additional influence may have a larger role in the ability to respond to supply disruption in the future. This is beyond the criticality calculation in scope, which is essentially looking at the current and recent past in terms of supply (see the Overall framework and scope section of this report).

As illustrated in the next paragraphs, several aspects in relation to additional influences are rather to be considered in the context of resilience (see section 1.2), thus out of the criticality calculations.

5.2 Land use competition

5.2.1 Summary

The provision of biotic and abiotic resources requires the occupation, transformation, and use of land. Land use regulations and protected areas may restrict the use of land for extraction activities. Similarly, different economic activities for industrial or residential purposes may compete with each other for the same land area. In this chapter, the influence of both, land use regulation and economic land use competition, on the supply risk of raw materials is discussed. The analysis shows that land use competition can be an important factor in the determination of supply risk. However, due to the complexity of the evaluation it is not recommended to incorporate issues of land use competition into the current criticality methodology. Information pertaining to both land use regulation and land use competition can, however, be included with the raw material factsheets and could be further investigated in the context of the EU criticality assessment in a future study.

5.2.2 Background

In the EC 2010 report (EC 2010), the Ad hoc Working Group on Criticality mentioned the possibility to consider policy actions to improve access to primary resources, including best practices in the area of land use planning and permitting. The report also mentions the role of competition of a potential mining site with other land uses (e.g., natural protection). In the 2013 study (Chapman et al. 2013), land use is mentioned as an additional influence in the early stage of raw materials supply, i.e., at the exploration stage (Figure 22). The report focuses on competing land uses within the EU itself, such as those protected by Natura2000²⁵, and investigated the overlap between Natura2000 sites and known mineral deposits. Nevertheless, the authors concluded that existing

²⁵ A coordinated network of protected areas in the world (see http://ec.europa.eu/environment/nature/natura2000/index_en.htm).

mining activities (for **abiotic materials**) indicate that land use competition between mining and natural protection is not a limiting factor in mineral deposit development. Apart from this mainly regulatory land use influence on domestic abiotic resource supply, the report also mentions economic land use competition as threat to the supply of **biotic materials**, where the cost-benefit ratio of an activity as compared to other alternative uses of the land determines land allocation. However, it should be noted that land-use competition varies according to each biotic material considered.

In conclusion, (Chapman et al. 2013) concentrates on land use as influence in the context of domestic supply in the early stages of the raw materials' supply chain, pointing to two different elements related to land use as additional influence. First, the report points to regulatory land use limitations like Natura2000 for deposits of abiotic raw materials. Second, mainly related to biotic raw materials, it mentions economic land use competition as potential influence. Apart from the EC 2014 reports (Chapman et al. 2013; EC 2014), land use is rarely reported as influence in criticality studies. Nevertheless, it must be explored how land use as an additional influence could be further developed, especially if biotic materials are considered in the assessment.

5.2.3 Analysis

Land use may be relevant in the context of supply risk in two ways. First, it could affect the supply risk when the production function of the land (e.g., mining) competes with the protective function (*regulatory/social* context). An example of such economic competition for land among several uses includes, e.g., mining versus urbanization. But based on the former EU criticality study, it may be mainly seen in terms of land use regulation and in this sense it would enable us to bring a specific *regulatory/social* issue into the methodology for the first time.

Essentially four issues for further elaboration are included in the analysis:

- Land use regulation: EU-28 and beyond
- Economic land use competition
- Vulnerability of specific raw materials to land use
- Land use: influence in supply risk or in mitigating supply risk

5.2.3.1 Land use regulation

The main land use regulations that can affect raw materials supply include: protected areas (e.g., designated areas for conservation of biological diversity such as EU Natura 2000), and product-specific legislation and incentive initiatives (mainly affecting biotic material supply). Both can impose restrictions to the exploitation of raw materials within a region and/or the conversion of the land from its original use to raw materials sourcing activities. While Natura 2000 is a network set at European level restrictions can also be set at country level either directly by the central government or by regional authorities. This restrictions may refer to minimum setback distances aiming at protecting natural resources e.g. water reserves: surface bodies, groundwater reservoirs and drinking water wells; infrastructures e.g. roads and railways, gas pipelines, electric transmission lines; permanently inhabited areas e.g. densely populated areas (air quality, noise pollution, etc.).

The International Union for Conservation of Nature (IUCN) definition of protected area is: "A clearly defined geographical space, recognised, dedicated and managed, through legal or other effective means, to achieve the long-term conservation of nature with associated ecosystem services and cultural values" (IUCN 2015). IUCN has established six categories of protected areas according to their management objectives. These categories are increasingly used worldwide by national governments for defining protected areas: Ia - Strict Nature Reserve; Ib - Wilderness Area; II - National Park; III - Natural Monument or Feature; IV - Habitat/Species Management Area; V - Protected Landscape/ Seascape; and VI - Protected area with sustainable use of natural resources.

Legislation on conservation areas may vary by country regarding the access to raw material resources within those areas. In general, IUCN protected areas of the categories I-II are more restricted to biotic resources use (e.g., forest products) than categories V-VI (Coad et al. 2008). The priorities for each IUCN category are listed in Table 18.

Table 18 Priorities defined for each IUCN protected area category. Key: 1 = Primary objective; 2 = Secondary objective; 3 = Potentially applicable objective; - = not applicable. Source (Eagles et al. 2002).

Management objective	Ia	Ib	II	III	IV	V	VI
Scientific research	1	3	2	2	2	2	3
Wilderness protection	2	1	2	3	3	-	2
Preservation of species and genetic diversity (biodiversity)	1	2	1	1	1	2	1
Maintenance of environmental services	2	1	1	-	1	2	1
Protection of specific natural/ cultural features	-	-	2	1	3	1	3
Tourism and recreation	-	2	1	1	3	1	3
Education	-	-	2	2	2	2	3
Sustainable use of resources from natural ecosystems	-	3	3	-	2	2	1
Maintenance of cultural/traditional attributes	-	-	-	-	-	1	2

Information on the location and characteristics of the protected areas can be found in the World Database on Protected Areas (WADPA et al. 2015). This is a database created by the IUCN and the United Nations Environment Programme (UNEP) and managed by UNEP-WCMC, incorporating information for both terrestrial and marine protected areas (Figure 23).

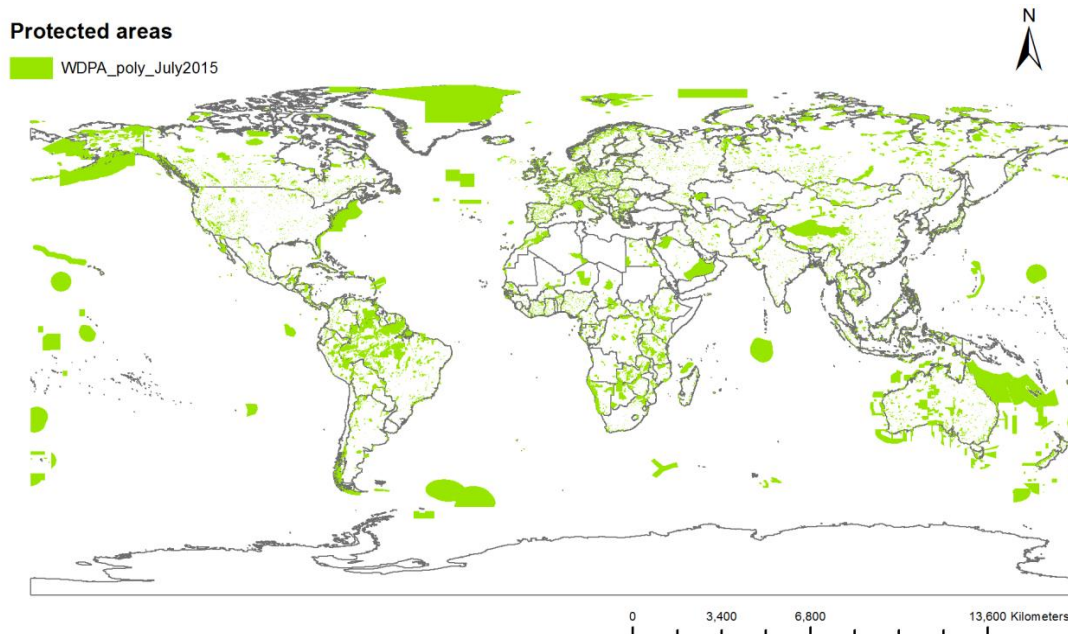

Figure 23 World protected areas. Source: Figure constructed using the world database of protected areas (WADPA et al. 2015).

According to the 2014 United Nations List of Protected Areas (Deguignet et al. 2014), in August 2014 a total of 209,429 protected areas were identified (with information from 193 countries) covering an area of 32,868,73 km² and referring to 3.41% of the world's marine area and 14% of terrestrial areas (15.4% excluding Antarctica). Those include all the areas that meet the IUCN definition of protected area (with or without IUCN management categories), designated sites under national, regional and international conventions and agreements. The distribution of protected areas is highly irregular in terms of size and number. Regarding inland protected areas, Central America and South Africa show the highest percentage of 28.2% and 25%, respectively. The Convention on Biological Diversity defined a 10 year plan to stop the loss of biodiversity, setting out the so-called Aichi Biodiversity targets to be achieved by 2020, the target 11 stipulates that "By 2020, at least 17 per cent of terrestrial and inland water, and 10 per cent of coastal and marine areas, especially areas of particular importance for biodiversity and ecosystem services, are conserved through effectively and equitably managed, ecologically representative and well connected systems of protected areas and other effective area-based conservation measures, and integrated into the wider landscapes and seascapes". Therefore, the world areas of protection are expected to grow further in the future.

Regarding the EU legislation on protected areas in compliance with the subsidiarity principle, direct regulation of land is a right reserved to the legislative bodies of each member state of the European Union. Nevertheless, matters of common interest that require harmonised action across the European territory in order to be effectively tackled are indeed regulated by the EU.

A number of EU legal acts²⁶, some of which binding, have been approved in several domains (natural protection, water quality and quantity preservation, etc.) and have

²⁶ Different types of EU legal acts are: Regulations (legally binding), Directives (legally binding), Decisions (legally binding), Recommendations and Opinions.

potential influence, either directly or indirectly, on the European landscape and, in consequence, also on the development of economic activities for the supply of raw materials.

Council Directive 92/43/EEC of 21 May 1992 on the conservation of natural habitats and of wild fauna and flora, together with Directive 2009/147/EC of the European Parliament and of the Council of 30 November 2009 on the conservation of wild birds, represent the most important Europe-wide policy on nature conservation. The two Directives are implemented through a network of protected sites (Natura2000 network). Each of these sites "shall enable the natural habitat types and the species' habitats concerned to be maintained or, where appropriate, restored at a favourable conservation status in their natural range" (Council Directive 92/43/EEC).

Human activities potentially hindering the integrity of protected natural habitats are discouraged within Natura2000 sites. The European legislation does not put explicit bans; on the contrary, it requires that the appointed authority at Member State level evaluates case by case the possibility for specific activities to take place within a Natura2000 site, and with which limitations. The Natura2000 dataset itself lists among the impact categories one specific type for "mining, extraction and energy production" and another related to "agriculture, forestry and animal breeding" (EEA 2016).

Furthermore, a stricter protection regime is enforced in priority sites where hosting of one or more species and/or habitats is classified as a priority. In these sites raw material sourcing activities are more likely to be banned or considerably limited.

In summary, the level of restriction imposed on mining or biotic sourcing activities by the presence of a Natura2000 site is a function of several factors, including: the overall level of protection of the site itself (priority or non-priority site); the type of natural habitats and species protected by the site (e.g., it is more likely that the level of restriction is higher when species/habitats are directly present within the area where the raw material sourcing takes place) type of level of disturbance expected (e.g., mining activities and technologies adopted, such as open pit, underground, etc.).

An additional element to be considered is the presence of Nationally Designated Areas (CDDA), often, but not always, overlapping with Natura2000 sites. These sites are classified by increasing levels of protection (i.e., from landscape park (lower level of protection) to natural reserves (higher level of protection), following the international convention set by IUCN. Nevertheless, as is the case with Natura2000 sites, each Member State implements slightly different legislative restrictions (banned activities) in each of these categories of protected sites.

Other elements potentially conflicting with mining or biotic sourcing activities in Europe and mentioned in EU legal acts are: the presence of High Nature Value (HNV) farmland (see CAP legislation); presence of flooded areas (see Floods Directive); presence of water bodies (see EU Water Framework Directive).

Information on Natura2000 and CDDA information can be found at the European Biodiversity data centre (BDC). <http://www.eea.europa.eu/themes/biodiversity/dc> (Figure 24).

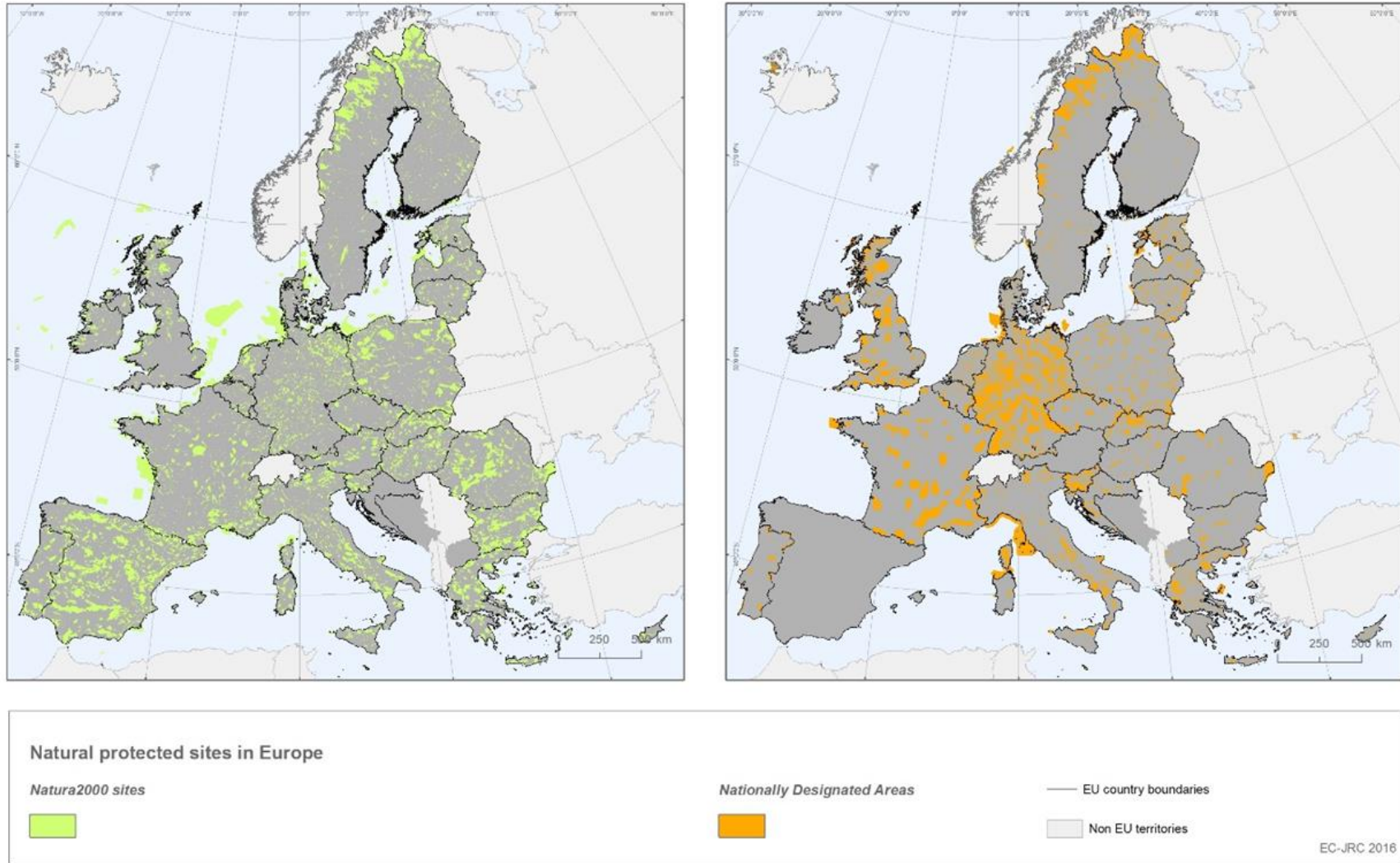

Figure 24 Natural protected sites in Europe. Data sources: EEA (Natura2000 network and Nationally Designated Areas).

Figure 25 reports an overview of mining locations with respect to the presence of Natura2000 sites. Data on mines have been derived from SNL Metals & Mining and include both active mines and mining sites currently not operational. Overall, more than 10% of the mapped mines in EU28 are located within a Natura2000 site. Nevertheless, almost 72% of mining locations are in close proximity (within a 5 km radius) of these natural protected areas.

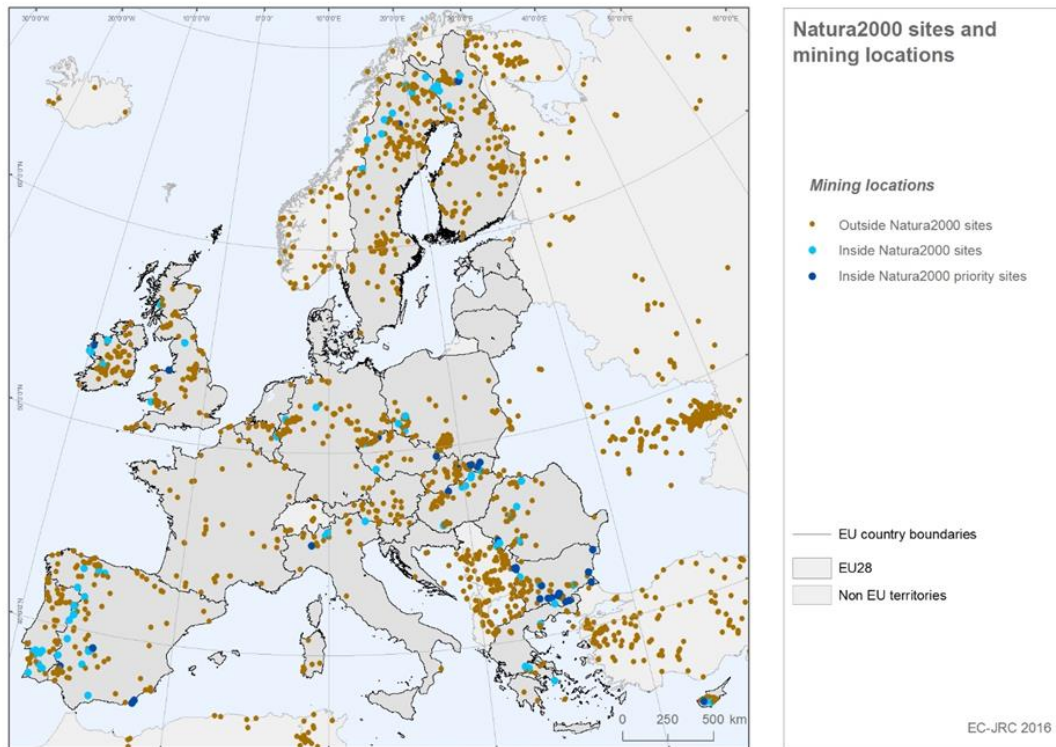

Figure 25 Location of mining sites (total) with respect to the Natura2000 network. Data sources: SNL (mining sites); EEA (Natura2000 network).

At European level, it is also possible to distinguish Natura2000 areas classified as “priority site”: according to Council Directive 92/43/EEC and Directive 2009/147/EC, this status implies that regulation and criteria applied for permitting human activities, are more stringent. Of the 10% mining sites located within Natura2000 areas, almost 30% fall within the boundaries of a protected area classified as “priority site”.

The information on distribution of protected sites (both globally and EU-wide) can be correlated with information on distribution of mining sites and biotic materials in order to depict areas where the sourcing of those materials may be subject to restrictions. This information will therefore allow the identification of areas where the productive function of land may compete with the conservation function. Generic information on forests within protected or designated conservation areas and production areas can be obtained (by country) from the Food and Agriculture Organization (FAO) (including the EU Natura 2000 and national designated areas) (FAO 2010a). For example, in 2010 Asia was the world region with the highest fraction of forest cover located within protected areas (23.7% in 2010) and nearly a quarter of the EU’s forest area is protected under Natura 2000 (EC 2013).

5.2.3.1.1 Product specific legislation and incentive initiatives (mainly affecting biotic materials)

Land use for biotic materials supply can also be subject to legislation on specific bio-based products. An example of such legislation is the renewable energy directive (EC/28/2009) (EC 2009), which stipulated “no-go” areas for sourcing biotic materials used in the production of biofuels used to fulfil the EU renewable targets. These restrictions included: primary forest and other wooded areas, areas designated for conservation of biodiversity, grasslands, highly biodiversity grasslands and lands with high carbon stocks (such as wetlands, peat lands and continuously forested areas). The fulfilment of these restrictions is demonstrated through voluntary schemes that certify the origin and supply chain of biofuels and their raw materials. This example of the EU renewable energy directive illustrates a product-specific legislation that could influence the supply risk of any biotic material.

Subsidies and incentives given to different commodities may change land use towards the production of the subsidised materials (e.g., vegetable oils for the production of biofuels). Additionally, initiatives such as Payments for Ecosystem Services (PES) and the Reducing Emissions from Deforestation and Forest Degradation (REDD+) can also influence land use. PES are incentives paid to, e.g., farmers or forest owners for maintaining services such as clean water, recreation, biodiversity habitats, and carbon storage. The REDD+ initiative offers incentives to developing countries that decrease or stop carbon emissions caused by deforestation and forest degradation and invest in low carbon strategies for development. Furthermore, the REDD+ includes also provisions for forests sustainable management and improvement of forests carbon stocks (UN-REDD 2015). However, it is important to highlight that only one per cent of the roundwood processed in the EU comes from tropical forests (DG GROW). These incentives can have either positive (e.g., directing the competition for land towards more sustainable exploitation of biotic materials) or negative (e.g., preventing sourcing activities that may require conversion of land use) effects on land use competition for biotic materials supply.

5.2.3.2 Economic land use competition

5.2.3.2.1 Economic land use competition for abiotic materials

Land use patterns and trends are the result of different actors competing for the same finite land resource, e.g., for the production of food and feed, industrial activities, or human settlements, and represent a system of complex interactions of the various actors involved. Besides the presence of legal constraints (see previous section), also the economic competition for land (this section) can potentially affect the supply risk of raw materials. Besides the value inherent in the land area, e.g., due to its size, location, or the presence of resource deposits, the land value also depends on the proximity to auxiliary resources (e.g., water of energy) and access to markets that provide goods and services to allow for any industrial or residential activities, for example.

With respect to these other competing functions, mining activities can either result in negative or positive interactions with the surrounding environment. The first is the case for human settlements if we assume that people generally do not prefer to live close to a source of air/water/soil/noise/visual pollution. On the contrary, for manufacturing activities it could be beneficial to be located in the vicinity of an extraction site in order to optimise the infrastructures in place.

These interactions also depend on the relative distance: for instance, people would like to live far enough from a mining site, not to suffer its potential negative impacts, but close enough to work there (a mine creates jobs and therefore attracts people).

In order to highlight the importance of these potential competitions and how they might evolve under future scenarios, Figure 26 reports the population living next to (5km distance) metals mining locations in years 2010 and 2050.

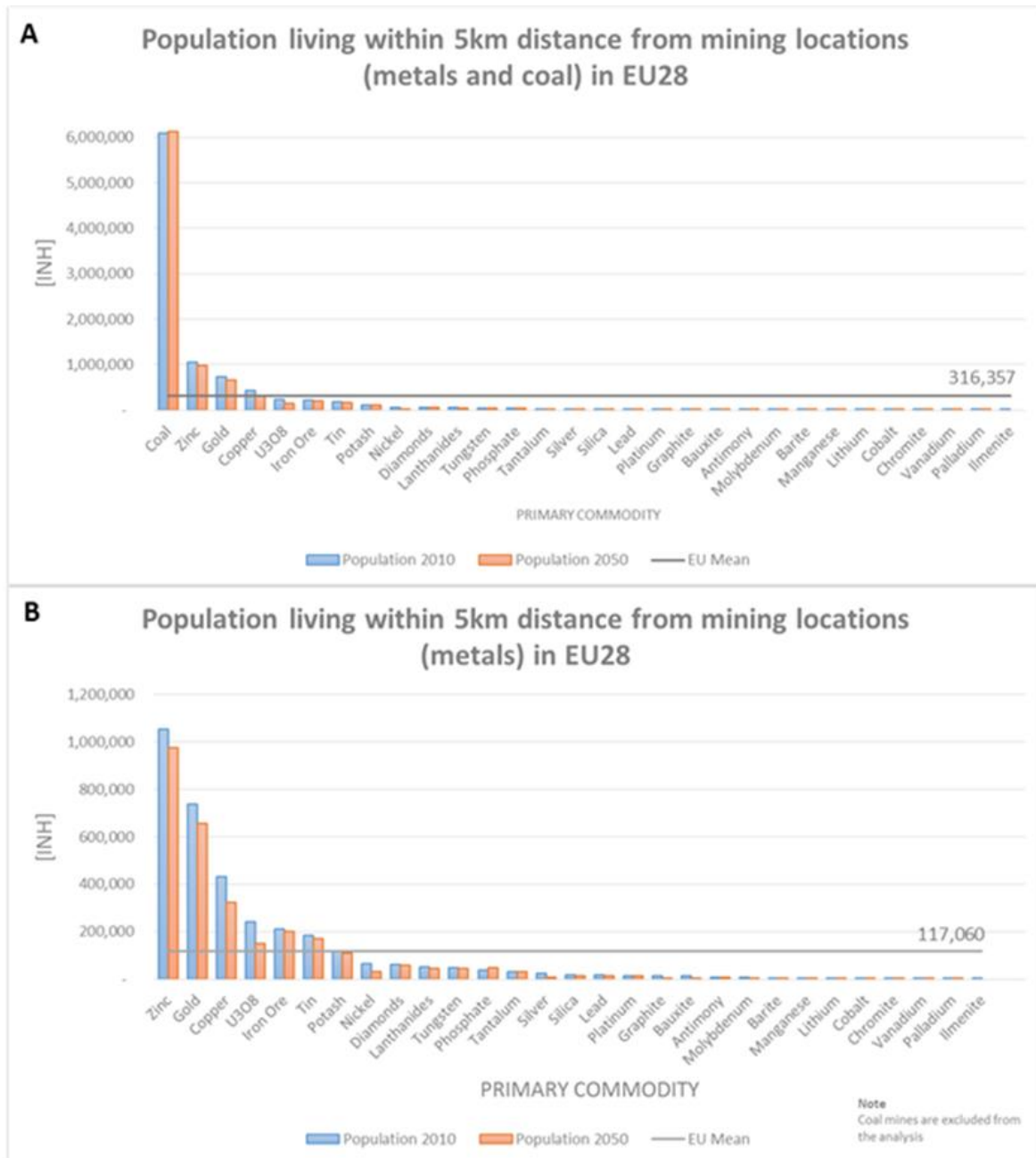

Figure 26 Population density in proximity to metals mining locations in EU28, for the years 2010 and 2050. The units are number of inhabitants living within a 5km radius from the mines. Graph A refers to all commodities, whereas coal mines are excluded from graph B. Data sources: SNL database, accessed on 12th June 2015 (current mining locations); LUISA platform simulations - EU Reference Scenario (population density maps).

The analysis is partially based on the output of the Land Use-based Integrated Sustainability Assessment platform (LUISA), developed by the JRC²⁷. In particular, the simulation for the EU Reference Scenario has been used (Baranzelli et al. 2014).

The knowledge and analysis of the territorial context in which mineral extraction activities take place, is necessary to understand how land use competition processes might evolve. Regional and local specificities play an important role. For example, Figure 27 and Figure 28 depict the case of a mining concession located in the Rhône-Alpes region. The area is characterised by the proximity to the city of Lyon (approximately 25 km) and by the presence of vineyards (classified under the category “permanent crops” in both figures).

²⁷ <https://ec.europa.eu/jrc/en/luisa>

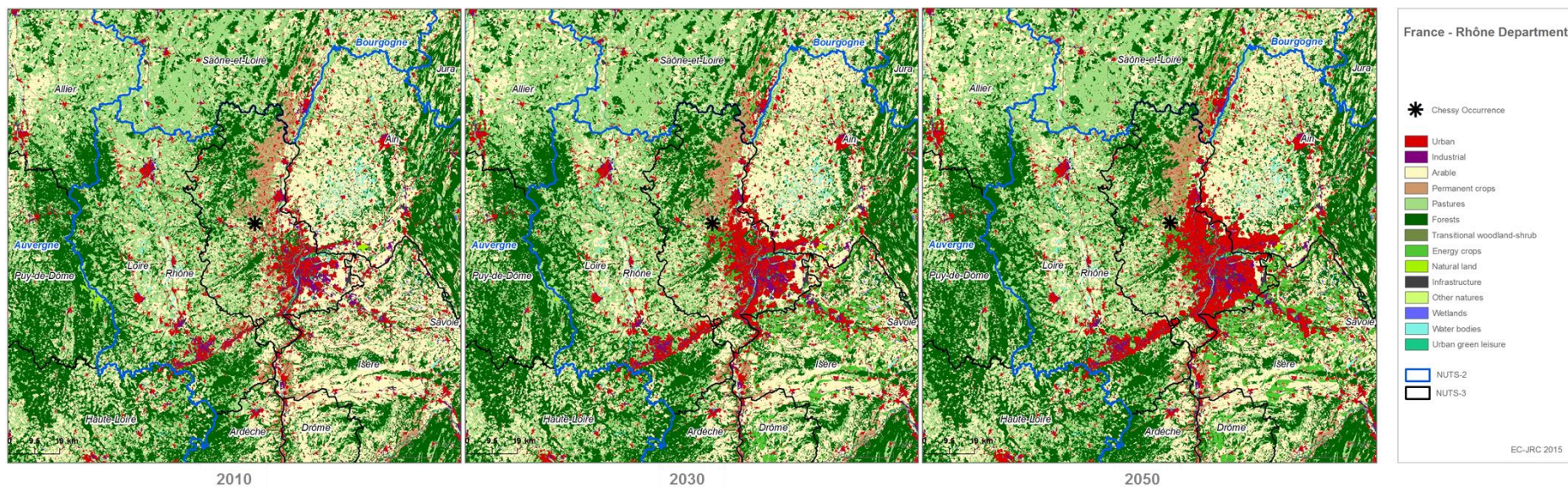

Figure 27 Simulated land -use/cover changes over the period 2010 - 2050, in the Rhône-Alpes region, Rhône Department. Data sources: G.E.G.M. - FRANCE (Chesy-les-Mines location); LUISA platform simulations - EU Reference Scenario.

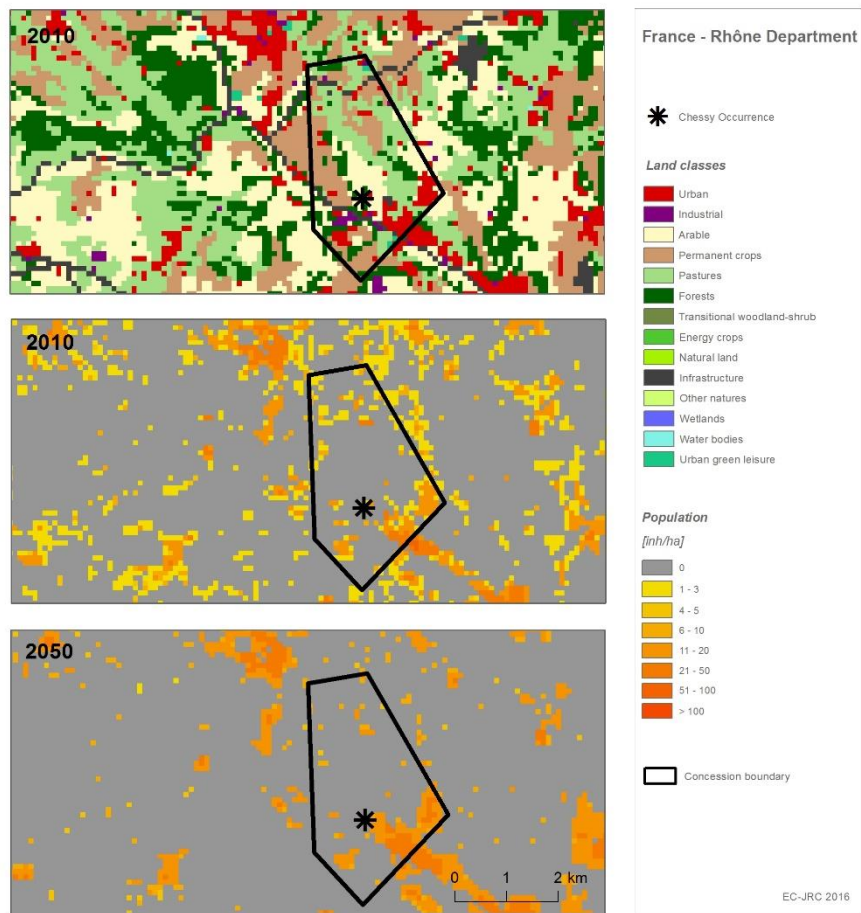

Figure 28 Zoom-in to the area nearby Chessy-les-Mines. Land –use/cover patterns in 2010 are represented in the first frame from above; population density in 2010 and 2050 are represented in the second and third frames, respectively. Data sources: G.E.G.M. - FRANCE (Chessy-les-Mines location); LUISA platform simulations - EU Reference Scenario.

Notably, under the EU Reference Scenario, the area next to the mine is subject to a process of urban expansion, where population distribution is projected to undergo a densification process. These dynamics, together with the close presence of valuable vine varieties, are likely to exacerbate the competition for land and resources.

Example: MINATURA2020

As the exploitation of EU-28 mineral deposits is considered to play a key role in ensuring that the needs of the European society can be satisfied in a sustainable manner, the potential of exploitable mineral deposits is evaluated in the MINATURA2020 project (<http://minatura2020.eu/introduction/>). In this project, the deliberation between mineral exploitation and other land use objectives is a challenging arena which requires informed evidence. In response to this challenge, the overall objective of this three-year project is to develop a concept and methodology for the definition and subsequent protection of “Mineral Deposits of Public Importance” in order to ensure their best use in the future with a view to being included in a harmonised European regulatory, guidance, or policy framework.

5.2.3.2.2 Economic land use competition for biotic materials

Regarding economic land use competition, biotic materials have also to compete for land with other economic activities, such as: mining, urbanisation, road transport, agriculture, plantation forestry and cattle farming (both agriculture and forestry can provide sources of biotic materials). According to FAO, from 2000 to 2010 up to 40 million hectares of primary forest were lost or changed, among the causes for this loss are land use competition with the above mentioned uses. The pressure on forests and their products will continue, due to population increase and increase demand for food and bio-based fuels (UNEP 2013). Worldwide land use competition is addressed in studies that model greenhouse gas emission from direct and indirect land use change (Laborde et al. 2014; Laborde 2011). The majority of these studies are, however, focused on land use competition between food and energy crops, due to the energy policies that promote biofuels and bioenergy.

In the context of the EU criticality methodology (focused only on non-food and non-energy materials) biotic materials differ from the abiotic ones because competition for land may go down to the specific competition between biotic resources species (e.g., different tree species) and take place not only between the general economic uses. Land use allocation is usually driven towards the most economically efficiency use, e.g., land primarily used for biotic material sourcing may be converted to grow more profitable market crops (such as palm oil, rice, sugar cane, and soya beans). However, as reported in the 2013 criticality study (Chapman et al. 2013) and mentioned above, incentives and subsidies may affect the cost-benefit ratio, favouring specific commodities to the detriment of others.

Data availability may limit the development of a complete evaluation of the economic land use competition for biotic materials supply. Data on land use competition are not widely available. General data on land use and land use cover, are available through different databases (e.g., from the FAO Land Use Systems of the World, (LADA 2010) and from the global land cover maps provided by the European space agency (ESA 2010)), but complete data on the distribution of individual biotic materials may not be freely accessible. Therefore, land competition between biotic materials and different commodity crops or other uses remains difficult to assess.

In the European context, the Joint Research Centre develops and maintains a platform devoted to the simulation of land-uses and related land functions changes across EU28. The Land Use-based Integrated Sustainability Assessment platform (LUISA) (also referred above) can be described as a platform with a land-use model at its core, linked to other upstream and downstream models, data, processes, and indicators (Lavalle et al. 2011; Baranzelli et al. 2014; Maes et al. 2014).

The allocation of land uses (LUs) to space is governed by a land-use optimisation approach, which is based on both rules and statistically inferred transition probabilities. In addition to exogenous suitability factors, such as terrain morphology and accessibility characteristics, other factors can also be accounted for: spatial planning, regulatory constraints (e.g. natural protected areas) and exogenous incentives do influence specific LU conversions.

LUISA can be therefore used in order to explore the combined impact of both legislative constraints and economic competitions among different uses/functions, comprising biotic materials supply in the EU context (see Figure 29 for an example).

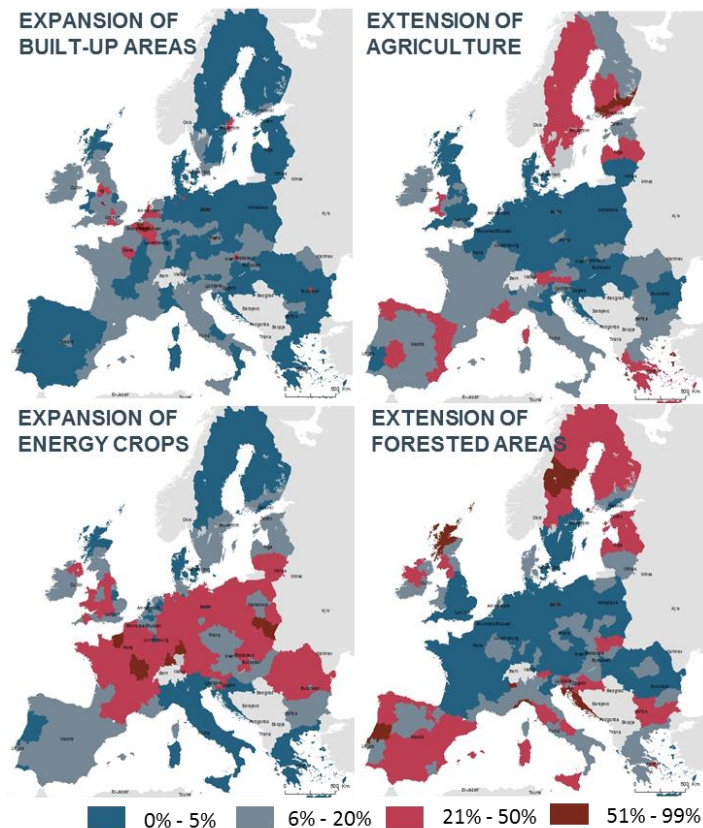

Figure 29 Example of aggregated simulation output from the LUISA platform. Percentage contribution of main land-use/cover changes across the European regions, as per the Reference Scenario. Source: (Baranzelli et al. 2014).

Example: The case of **cork production** is particularly interesting: in fact, cork production is a major economic activity in Portugal, the country with the largest cork oak area (ca. 730,000 ha) and the biggest cork producer in the world (around 50%). Nevertheless, cork oak woodlands are recognised as a strategic resource by the Portuguese government from a socio-economic, but also environmental, perspective .

In particular, Cork oak (*Quercus suber*) silvopastoral woodlands are part of the semi-deciduous and sclerophyllous vegetation of the Iberian Peninsula which forms a complex and highly diverse landscape of woodlands, shrublands and extensive semi-natural grasslands. This landscape is very valuable in terms of biodiversity conservation, soil protection, and hydrological stability.

However, deforestation, agriculture intensification, and resulting soil erosion, combined with other biophysical stress factors (e.g., increased frequency of long drought periods) have altered the landscape significantly over the last century, contributing to a steep decline of cork oak woodlands in Portugal, particularly during the 80s and 90s (De Sousa et al.). A decline in the intensity and quality of management is also a contributory factor.

These developments have compelled the Portuguese government to implement in 2001 a legal framework for the protection of cork oak woodlands²⁸. In addition, an official programme has been also launched for recovering and improving the management of these ecosystems (MADR 2003). As a result, total cork oak land cover has stabilised in recent years, decreasing by only 1% between 1995 and 2010 (ICNF 2013).

In 2010, the cork sector in Portugal amounted to 1.5% of national industry production and 2.1% of total exports (AdC 2012). Cork sales are essentially composed of raw materials, cork intermediate products and final products such as cork stoppers for wine bottles, construction materials, and thermic and acoustic insulation materials (AdC 2012). The competitive structure of the sector differs considerably along the product value chain, and even within some particular stages. There is substantial discrepancy particularly at the raw material production stage, with 30% of cork woodland area producing less than 0.01% of the total national production (AdC 2012), mainly due to:

- poor vitality of cork oak systems, with 60% of evaluated area in poor conditions and 8.2% of the trees being dead
- high fragmentation of property, thus precluding economies of scale. Currently, two main factors contribute to property fragmentation: 1) fractionation of inherited property by the successors; 2) low coverage of rural land registry for taxing purposes, therefore decreasing rural land market liquidity.

Furthermore, there is large degree of market share concentration by Amorim Group (AdC, 2012), the world leader in the cork sector. The disparity in market power and reputation creates large information asymmetries, which increase the risks and hampers the development and implementation of strategies by smaller companies and/or potential entrants. In fact, four of the ten largest sector groups in Portugal have exited the market over the last 10 years.

Thus, three main processes can be currently identified:

- cork oak woodland area in Portugal has stabilised over the last decade, due to the implementation of a legal framework protecting these ecosystems;
- however, the quality of cork oak woodland systems remains low in a relatively large area;
- increasing market share concentration by the largest cork production group leads to low competitiveness of the sector and creates obstacles for smaller producers, thus increasing the risks for preserving cork woodland systems in good conditions.

On the demand side, despite the recent increase in cork exports in value (APCOR 2015a), Portugal's cork export volumes have been decreasing during the last decade (APCOR 2011, 2015a).

The demand for cork in Portugal is mainly driven by developments in the wine sector, with cork bottle stoppers comprising 70% of the total cork production in value (euros) (APCOR 2015a). Since the 1980's, global wine production has been in decline (Klerath and Wang 2013). Despite a slow recovery around the turn of century, wine production has peaked in 2004, reaching in 2012 the lowest levels in more than 40 years, as a result of poor weather conditions and the ongoing structural removal of capacity in

²⁸ Decree-law no. 169/2001 of May 25. Diário da República no. 121, Série I-A

Europe. Compared to 2005, Europe had reduced its winemaking capacity by roughly 10% in 2012 (Klerath and Wang 2013), with the steepest declines being observed in large producers such as France (10%) and Spain (13%). In comparison with these trends, the decrease in wine production in Portugal has been relatively small, with an average annual decrease rate of -0.01% in the period between 2000 and 2015 (IVA 2015). However, the production of cork stoppers in Portugal appears to be mostly directed towards international markets (AdC 2012), since exports account for 63% of the total production (APCOR 2015b). Therefore, developments in the international wine markets should be expected to play a bigger role than the domestic market, particularly in the United States (18% of total stopper exports in value) and Europe (around 70%, of which France: 19%; Spain: 11%; Italy: 10%). The observed decrease in export volumes (APCOR 2011) might thus be a consequence of the considerable removal of wine production capacity in key export countries such as France and Spain. Furthermore, the increase in the use of alternative materials (e.g. plastics stoppers and aluminium screw-tops) in countries such as the USA and Australia (where wine production has actually been increasing) might pose additional pressures for the cork sector (WWF 2006).

The construction sector also plays an important role on the demand for cork, accounting for 26% of total exports in value and 70% in volume (APCOR 2015a). The construction sector was severely affected by the economic crisis in 2008-2009. For example, the issue of construction permits in the European Union has decreased on average by 6.3%/year between 2007 and 2010, compared to an annual growth rate of 2.2% between 1993 and 2007 (AdC 2012). These recent developments had a significant impact on the cork sector. In Portugal, for example, historical low levels of cork demand were recorded in 2009 as a consequence of the crisis in the construction sector, only comparable to those observed in the 1930's (AdC 2012).

The combination of pressures in the cork sector from both the supply side (poor forest management practices) and the demand side (decline in the global cork markets) currently poses a number of inter-related threats to the preservation of cork woodland landscapes. Furthermore, changing climatic conditions and related risk of diseases and forest fires might put their sustainability at risk (see next sections for more information on these influences on biotic materials), leading to processes of land abandonment, loss of irreplaceable biodiversity and accelerated desertification within the coming decades.

5.2.3.3 Vulnerability of specific raw materials to land use

In function of the vulnerability to land use regulation and economic land competition, it is important to identify the difference in dependence on (EU-28) land among different raw materials.

A first factor in this context is the sourcing of the raw material, i.e., mainly EU production or non-EU production. As an example, consider beryllium versus feldspar. The EU has no share in the 259 tonnes produced worldwide in 2011 (EC 2014), but for feldspar, the EU has a relevant contribution of 35% of the global production in 2010, making it relatively self-sufficient (EC 2014). As a result, the EU land use regulation and economic competition is irrelevant in the analysis of land use as a supply risk factor for beryllium.

For those raw materials that have a significant EU primary production, it is worth to find out the vulnerability of raw materials to land use in function of their land footprint. Indeed, some raw materials can have a higher or lower need of land in function of the ore concentration, soil quality, water availability, the required facilities and auxiliaries, and whether they are mined open pit or underground. For example, when comparing copper with feldspar in terms of land to be transformed as inventoried in environmental

life cycle assessment (LCA) databases, the land footprint of copper is about two orders of magnitude higher on mass base.

5.2.3.4 Land use: influence on the supply risk or a factor to mitigate supply risk?

Land use, and in particular land use regulation, may be factors that do not mainly lead to immediate supply disruptions as such, but it may be even more important to mitigate future supply disruptions, i.e. in function of resilience. Following the paper on resilience in material supply chain by (Sprecher et al. 2015), increase of primary production from EU 28 sources is an obvious strategy to cope with supply disruptions; see for example the mapping of rare earth concentrations in agricultural and grazing-land soils in Europe in response to the 2010 rare earth crisis (Sadeghi et al. 2013). In this mitigation path, EU land use regulation can be an important factor that undermines the resilience of the EU in coping with supply disruption, next to lack of substitution or poor recovery from secondary sources. As resilience to supply disruptions is out of the scope of the current criticality assessment (which consists of economic importance and supply risk), it is questionable whether to introduce land use and in particular land use regulation as an additional supply risk factor.

Economic land use competition on the other hand, in particular for biotic raw materials, may be different as the economic competitiveness may be a factor that can influence the supply more directly if e.g. competition for other land uses at cork or natural rubber fields is facing an increased competitiveness of other land use types, e.g. urbanisation.

5.2.4 Concluding remarks on land use competition

With respect to land use as additional influence in criticality, the following conclusions of the study are provided in function of further development:

- Before any further development, it is to be defined if the development is to be focused on land use in EU28 solely or beyond. Data and maps for extra-EU may pose problems in terms of availability.
- In deciding on land use regulation, one has to be aware that it may be more important in resilience to supply disruption than being a risk factor as such.
- If land use is to be introduced as additional influence in the criticality methodology, it is unlikely that it can be implemented in a screening stage, i.e., in the criticality formula. More likely is that it fits into a more detailed criticality assessment, or maybe more adequately in assessing EU's resilience to supply disruptions.
- In case of implementation of EU-28 land use in a detailed criticality assessment, the focus should be on those raw materials with important EU-28 primary production and with an important land footprint (e.g. by open pit mining). Here, the EC-JRC can rely on land use mapping to identify potentially conflicting land use regulations and/or economic land competition. Also information from the Minerals4EU project may provide relevant data and maps.

In the revised methodology:

In conclusion, the analyses performed by JRC showed that **land use competition can be an important influence to the supply risk** of raw materials. Nonetheless, due to the complexity of this issue, and to keep the assessment within its current scope, no ready-to-implement proposals are recommended by the JRC to introduce land use competition in the calculations for criticality.

However, several aspects related to land use competition can be **incorporated in the material fact sheets**. JRC will continue to work on this topic also in collaboration with the Minatura2020 consortium.

Land use regulations in the raw material fact sheets: If available, information should be added in the material fact sheets, to identify the existence of regions (within the supplying countries) where the conservation function of the land competes with the production function for the abiotic or biotic material under consideration. This should be done by identifying the type of protection and the restrictions applied. Additionally, information should be added on legislation that promotes or prevents biotic and abiotic material sourcing within a supplying region.

Economic land use competition in the raw material fact sheets: If the raw material is known to be subjected to economic land use completion, this should be highlighted in the material fiches. This should be done by identifying the other use competitor and explaining how this competition will affect the supply of the biotic material.

Future work: There is the need to improve the availability of georeferenced data for raw material resources.

5.3 Mining governance

5.3.1 Summary

The level of governance in countries from which raw materials are being sourced is an important consideration in the evaluation of supply risk. Various indices exist that could be used toward such an evaluation, including, e.g., the World Governance Index (WGI), Extractive industries transparency initiative (EITI), Revenue Watch Institute's Resource Governance Index (RGI), and Policy Potential Index (PPI). A detailed discussion of country-level governance in the supply risk evaluation is provided in section 3.3. The analysis concludes that, even though WGI is not a production specific index, it nevertheless presents a suitable approach for including governance issues in the supply risk calculation. WGI provides country-level information relevant to the whole raw materials value chain, and can be used in the context of both abiotic and biotic materials. However, indices including PPI and RGI also represent valuable approaches that could be used in addition to WGI, if current limitations such as reduced coverage or data representation/transparency are overcome in the future. Furthermore, it might be worth to consider the level of governance not only in the mining/harvesting stage, but also in subsequent supply chain stages.

Please refer to section 3.3. for a detailed discussion of the topic.

Confirmation of the current methodology:

→ In the revised methodology, the **WGI should be kept** as indicators able to mirror aspects of country governance that are essential factors determining raw materials supply risk, including governance aspects of the whole country, WGI indirectly embodies all the steps of the raw materials supply chain and is not limited to only abiotic materials (as is the case for the EITI, PPI and RGI).

→ The **WGI should be used as it is currently done, i.e., the average of all WGI dimensions, which appears to be a robust approach.**

5.4 Sustainable sourcing of biotic materials

5.4.1 Summary

The level of governance in countries from which biotic materials are being sourced is an important consideration in the evaluation of supply risk. Poor sustainable management of forests and natural areas can reduce the availability of biotic resources. Data on the existence of biotic certification schemes and sustainable resource management may be capable of providing relevant information for biotic materials in criticality assessments. This chapter reviews some of the certification schemes relevant to the sourcing of biotic resources and information on sustainable resource management, and discusses the possibility to also use the World Governance Index (WGI) in the evaluation of supply risk of biotic materials. WGI is a useful proxy of governance issues in the current criticality methodology and may be complemented with information on sustainably managed harvesting areas in a future study.

5.4.2 Introduction

In the previous section mining governance was addressed as an important aspect in the supply risk of abiotic materials. This aspect is related to mining management strategies addressing economic, social, and environmental costs and benefits. For biotic materials these issues are also important because losses of forests and other biotic resources are connected with weak sustainable management (weak governance). Issues of weak governance are mainly present in countries with no proper legislation in place or lacking policy enforcement. This may lead to losses of productivity and difficulties to maintain an adequate supply of a biotic material, ultimately resulting in supply shortages. Additionally, on the demand side environmental and social concerns may shrink the available resources of biotic materials to suppliers that guarantee sustainable management of forest and plantations. Sustainable management aims at preserving and enhancing the economic, social and environmental value of the resources.

5.4.3 Analysis

Indicators on sustainable forest management are being developed by several initiatives (Ross 2015). However, at the moment a single common indicator able to assess sustainable management of resources is missing. In the global forest resources assessment of 2010 (FAO 2010a), as a pilot study, FAO asked countries for the first time to provide data on areas considered to be under sustainable forest management. However, since there was not a common definition of sustainable forest management (SFM), the results obtained cannot be compared from country to country.

In the EU, the concept of SFM was defined in 1993 at the pan-European Ministerial Conference on the Protection of Forests in Europe (MCPFE) as:

"The stewardship and use of forest lands in a way and at a rate that maintains their productivity, biodiversity, regeneration capacity, vitality and their potential to fulfil now and in the future relevant ecological, economic and social functions at local, national and global levels and that does not cause damage to other ecosystems."

Further work on SFM criteria is carried in Forest Europe (successor of the MCPFE), with periodic updates.

Similar definitions were also developed in America (North America: the Montreal Process, Central and South America: the Tarapoto process) (EC 2015).

An additional indicator used by FAO (FAO 2010a) and United Nations Economic Commission for Europe when assessing forest management is “area of forest with a management plan”. However, the existences of a plan does not guaranty that it is effective towards sustainable management. It only embodies a written intention to try to ensure that SFM criteria are respected Figure 30 shows the results on the reported areas with a management plan. This data was subject to country reporting and cover 79 percent of the global forest area (FAO 2010a).

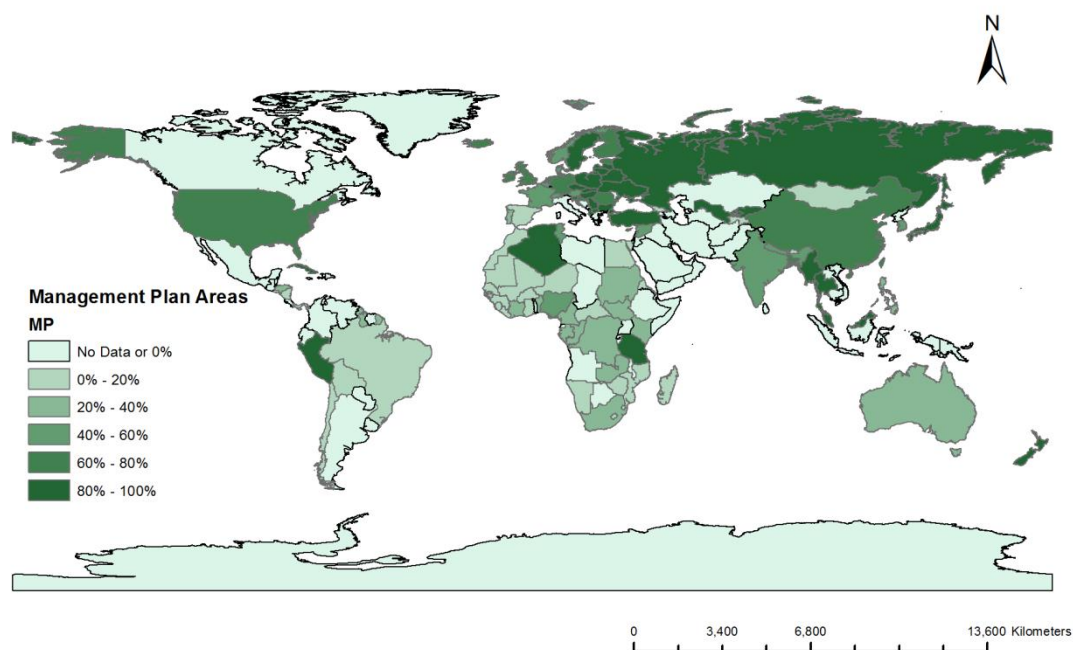

Figure 30 Distribution of reported forest areas with a management plan. Percentage of forest in 2010. Source: FAO global forest resources assessment of 2010 with a management plan.

Sustainable forest management is certified mainly by two certification schemes: The Programme for the Endorsement of Forest Certification (PEFC) and the Forest Stewardship Council (FSC). This certification attests that the resources are managed accordingly with the principles of sustainable development. The two together account for about 98% of the worlds certified forest area (PEFC 2014; FSC 2013) and 10 per cent of the forest areas have double certification from both PEFC and FSC. FSC is a multi-stakeholder organisation that provides centralised accreditation according to its defined standards, while the PEFC is an umbrella organisation that operates by endorsing national certification systems. These schemes are based on sustainable principles that guarantee good forest management; they include specific management for long-term harvesting goals, reforestation, and impact assessment of sourcing activities (Sikkema et al. 2014). Both of these certification schemes have two main types of certification: (1) forest management certification directed to forest managers or owners; (2) chain of custody certification directed to traders, directed to manufactures and all other entities processing forest goods after sourcing.

The EU has a specific legislation against the placing of illegal timber on the EU market (the EU Timber Regulation). Based on this, each economic operator introducing timber and timber products within the EU market shall guarantee traceability of the timber

supply chain and exercise a due diligence system that shall be maintain and regularly evaluated.

The FSC and PEFC certifications²⁹ encompass several requirements to attest sustainable production of forest products (including products such as wood, natural rubber and cork), while preserving biodiversity and avoiding negative social and environmental impacts.

A more complete analysis can be done by desegregating the available data in order to obtain: tree species/or product specific information. At the moment it is possible to obtain the overall certified area per country, taking into account that some forest areas are certified by both schemes and double counting is expected by combining the total certified area. Data on forest certified areas per country is also available in the FSC and PEFC statistical reports (FSC 2014; PEFC 2014).

Figure 31 shows data of certified cork oak forest in Portugal and Spain as an example of desegregated data for biotic material (APCOR 2011).

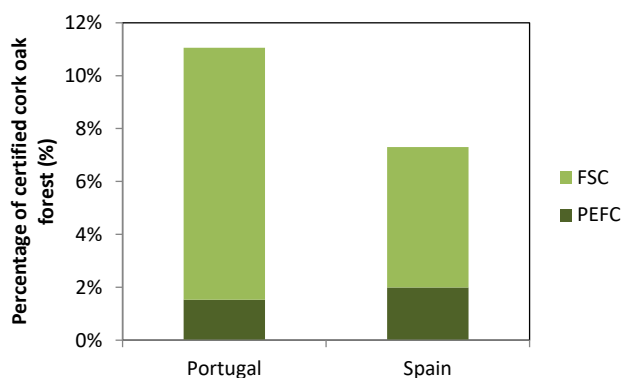

Figure 31 Percentage of certified cork oak forests, an example for Portugal and Spain.

The percentage of certified forests is still low due to cost and administrative burdens, however PEFC and FSC certifications are increasing fast all over the world and the certification schemes have already created measures to decrease the burdens upon small forest owners (e.g., through group certification).

Other certification schemes can be used to account for good resource management whether or not the biotic material under consideration is under the scope of PEFC or FSC. These include: Round Table for Sustainable Palm Oil (dedicated to palm plantation), FairWild (for medical and aromatic plants), Round Table on Responsible Soy, International Sustainability and Carbon Certification (global scope for food, biofuels, and materials), and others more focusing on bioenergy uses of biotic materials³⁰. For natural rubber, the sustainable Natural Rubber Initiative (SNR-i) was created to "secure a global sustainable natural rubber economy that delivers benefits across the whole of the natural rubber value chain", with criteria on: improvement of productivity, enhancement of natural rubber quality, forest sustainability, water management, and human and labour rights. <http://www.snr-i.org/index.php>

²⁹ Information on the forest management certification is available in the FSC and PEFC databases and monthly reports, which includes information on the certified hectares, tree species, and forest product (e.g., cork or natural rubber).

³⁰ <https://ec.europa.eu/energy/en/topics/renewable-energy/biofuels/voluntary-schemes>

5.4.4 Concluding remarks on sustainable sourcing of biotics

Poor sustainable management of biotic resources may result in difficulties to maintain an adequate supply of biotic materials. At the sometime on the demand side, environmental and social concerns may shrink the available resources to suppliers that attest good management of forests and plantations. Data on certified areas of biotic sourcing can be included in the material fact sheets. In future assessments with more focus on biotic materials, this information may also be considered to adjust WGI in order to decrease supply risk in certified areas.

For the **revised methodology**, in section 3.3. the JRC concluded that WGI should be kept since it translates aspects of country governance that are essential for raw material supply, not differentiating biotic or abiotic materials. However, a more target approach for biotic materials is proposed for future improvements.

Sustainable sourcing in the material fact sheets: Information on the existence of certification schemes that attest good resource management of the target biotic material should be included in the material fiches. This should include the name of the scheme, a general description, and percentage of harvested area certified in each supplying country. Also information of good practices of biotic resource management should be included.

Possible future improvements: The quantification of sustainable management harvesting areas within a country for a given biotic material (e.g. using percentage of non-certified forests or non-certified biotic materials) may be used in combination with WGI to introduce in the methodology a component of the supply risk that will be dependent on biotic management. Since WGI gives a general overview of country governance, the information on sustainable management of biotic may be used for adjusting WGI (scaled) when calculating biotic supply risk, similarly with what was suggested for trade restrictions, in section 3.4. In this way the corrected WGI will increase with the share of non-sustainable managed areas and therefore supply risk will be higher in those regions. Information on the share of non-certified areas could be used for this proposed improvement, since the coverage of these certifications is increasing worldwide (including on product supply chain certification) and are an important indicator on sustainable management of biotic materials. However, other indicators that can be used to account for biotic sustainable management should also be considered, a good option could be to follow the development of the indicators within the Global Forest Resources Assessment, by FAO.

5.5 Supply chain approach

5.5.1 Summary

Accounting for the source concentration (i.e., the number of countries involved in raw materials production) in connection with the level of country governance is important in the determination of supply risk. This chapter discusses the need to account for source concentration along the different stages of a raw materials' supply chain, i.e., not only the mining/harvesting stage, but also subsequent life cycle stages such as material processing and refining. Recommendations are provided on how to systematically adopt a supply chain approach via bottlenecks screening (i.e., a stage with the highest supply concentration) in the supply risk calculation.

Please refer to section 3.2. for guidance on implementation in the revised methodology.

5.5.2 Introduction

Unlike the aforementioned additional influences, land use and mining governance, the additional influence of supply chain criticality is found further down in the value chain. The 2014 report (EC 2014; Chapman et al. 2013) discussed the refining stage. The report refers to the AHWG comments which suggested '*examining not only the mining stage but also the smelting and/or refining stages of the supply of raw materials*'.

The 2013 criticality study (Chapman et al. 2013) analysed in chapter 5.4 (page 59) the refining stage of the supply of several raw materials and provided few example of this analysis. Data on geographically distribution of production for mining and refining stages are given for bauxite (mine) vs. aluminium (refinery), manganese (mine vs. refinery), nickel (mine vs. refinery), and zinc (mine vs. smelter). The report concluded that assessing the supply risk at different stages of the value chain, e.g., mining and refining, can lead to different results based on changes in the concentration of production.

5.5.3 Analysis

Metal and refining production fits with geographical concentration and is basically a further development of the country concentration factor, already incorporated as key supply risk factor. The added value would be a further detailing of the concentration of stages in the supply chain, i.e. not only at the mining or harvesting stage but also further downstream at the metal and refining production stages or for biotic materials in post-harvesting stages (e.g., vulcanisation of natural rubber) where the material may be further processed or refined before manufacturing.

From the literature study and the overall picture of influences on supply risk, metal and refining are an important influence. Proper analysis of the supply chain and taking into account the locations and producer concentration at each stage of the supply chain may significantly change the quantification of the risk. The location is highly important: reporting just the location of "primary production" is insufficient; it should be better detailed in function of its stages.

It is worth to consider what happens after the mining in a more generic process, i.e., not limiting it to "metals" as raw materials and "refining" as the only downstream process. Indeed, to account for both abiotic and biotic materials, the process chain can be

simplified into "mining/harvesting" followed by "post-mining/post-harvesting". Thus, the "primary production" should be detailed as follows:

- Concentration of the mining/harvesting operations;
- Concentration of post-mining/post-harvesting (e.g. refining, concentrating, beneficiation).

To illustrate, the importance, the case of Lithium is elaborated. Lithium is produced from two main sources:

(i) Lithium minerals (i.e. spodumene, petalite, and lepidolite). Mineral production is dominated by Australia (40.4 % of global lithium output in 2012), but the conversion of lithium minerals takes place at facilities predominantly located in China.

(ii) Lithium brine. Production of lithium brines sources is confined to Chile, Argentina, USA and China, together accounting for 51 % of global lithium output in 2012.

Country share of lithium production at "mining" and "refining" stages is presented as pie chart in Figure 32.

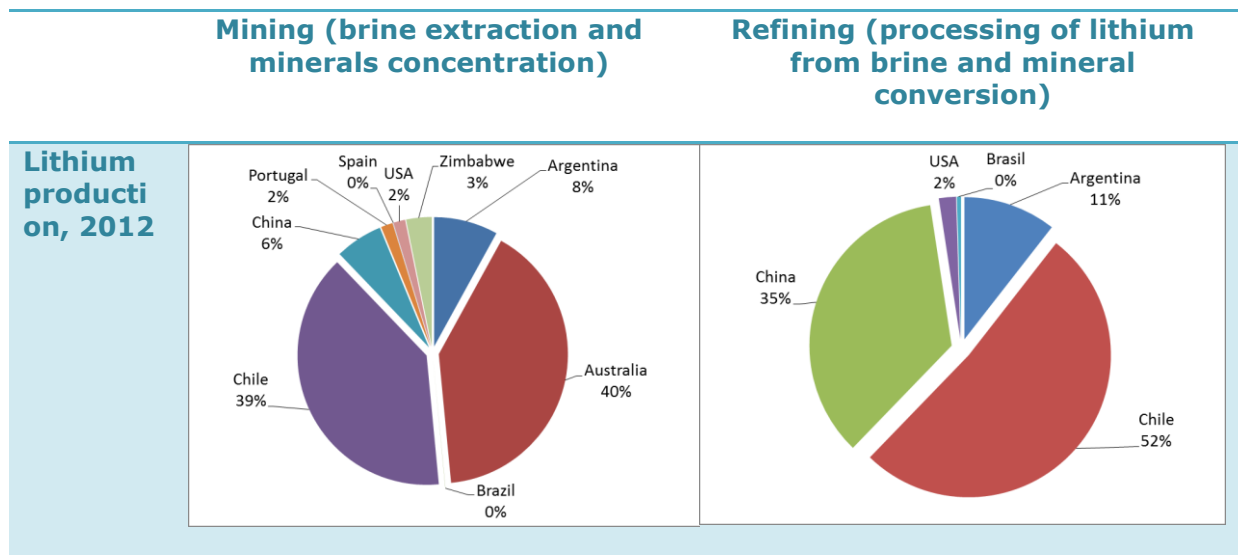

Figure 32 Geographical distribution of lithium mining and lithium refining.

If one calculates the HHI on the base of mining ($HHI_{WGI, mining}$) and on the base of the refining, the following numbers are obtained:

$$\begin{aligned}
 HHI_{WGI, mining} = & (8.02^2 \cdot 5.43_{Argentina}) + (40.46^2 \cdot 1.74_{Australia}) + (0.02^2 \cdot 4.73_{Brazil}) + (39.33^2 \cdot 2.58_{Chile}) + (5.96^2 \cdot 6.18_{China}) \\
 & + (1.49^2 \cdot 3.15_{Portugal}) + (0.04^2 \cdot 3.13_{Spain}) + (1.49^2 \cdot 2.53_{USA}) + (3.21^2 \cdot 7.95_{Zimbabwe}) = \mathbf{7501.26}
 \end{aligned}$$

and

$$\begin{aligned}
 HHI_{WGI, refining} = & (10.54^2 \cdot 5.43_{Argentina}) + (51.68^2 \cdot 2.58_{Chile}) + (35.35^2 \cdot 6.18_{China}) \\
 & + (1.95^2 \cdot 2.53_{USA}) + (0.47^2 \cdot 4.73_{Brazil}) = \mathbf{15230.73}
 \end{aligned}$$

The result shows that the risk factor based on the post-mining (i.e., refining) stage is about double the risk of the mining stage. As the supply risk may be determined by the most risky stage in the production chain (bottleneck), it is worth to consider the risk factor of the post-mining stage.

5.5.4 Concluding remarks on supply chain approach

With respect to supply chain approach, the following can be concluded:

- Already from the 2014 report, it is obvious that the geographical spread of post-mining/post-harvesting can be very different from the mining/harvesting country concentration: for some raw materials the unrefined mining product is shipped to other countries for further processing. Hence, this difference in country concentration may heavily impact the proper quantification of the supply risk.
- Consequently, it is of utmost importance that the risk factor HHI_{WGI} is defined and reported clearly.

Changes considered in the revised methodology:

It is recommended to systematically adopt a *supply chain approach by means of a "bottleneck screening"*, i.e., relying on the principle that the weakest stage in the chain dominates the supply risk:

- (1) Screen for all raw materials (e.g., judgement by a network of experts or a qualified team) if there is a significant difference in the country distribution of mining/harvesting versus post-mining/post-harvesting;
- (2) For cases without significant difference: use mining/harvesting countries to calculate HHI_{WGI} ;
- (3) For cases with significant difference:
 - calculate both $HHI_{WGI, \text{mining/harvesting}}$ and $HHI_{WGI, \text{post-mining/post-harvesting}}$;
 - take $\max[HHI_{WGI, \text{mining/harvesting}}; HHI_{WGI, \text{post-mining/post-harvesting}}]$ for calculation of the supply risk, as the overall risk is essentially determined by the weakest link in the supply chain.

5.6 By-production dynamics

5.6.1 Summary

Many of the materials used today are obtained as companions from the same ore bodies (metals) or are produced in multi-output processes in subsequent processing and refining stages. For example, germanium and indium are obtained as a companion metal from zinc ores. For biotic materials, a sawmilling process may produce multiple product outputs including, wooden planks, sawdust, saw chips, and forest residues that are considered as main, co-, and by-products, depending on their economic market value. By nature of their by-production status, companion products are prone to risk related to the host material (e.g., because they depend on the demand of the host material). This chapter discusses the issue of by-production in more detail and concludes with some preliminary ideas of how the issue of by-production may be included in a criticality assessment in the future.

5.6.2 Introduction

By-production dynamics have been included as additional influence to criticality in both previous EC criticality studies. The EC 2010 report reported that 'Defining critical raw materials' states that by-product dynamics are an aspect to consider when assessing the geological availability of raw materials (EC 2010). Three different types of by-products or coupled products materials are distinguished: metals derived from ores of major or 'carrier' metals (i.e., gallium from bauxite, germanium from zinc), coupled metals that occur without a real metal carrier (i.e., platinum group metals, rare earth elements), and by-product metals mined as target if found in high concentrations (i.e., cobalt, gold). By-products are considered to have highly complex demand/supply relationships, technology and investment requirements, and price patterns. The study concludes that the supply risk of these metals is high when the volume mined does not match with market demand. By-product metals can depend on the demand for the carrier material which, if decreasing, may result in supply risk implications for the by-product material.

In (Chapman et al. 2013), by-product metals are regarded as quite different to primary products, and their production considered to be largely driven by demand for the primary metal. The discussion about by-product dynamics is further illustrated by the 'wheel of metals' developed by (Verhoef et al. 2004) which shows metal interconnection and interdependencies.

The 2013 study also includes a discussion about three additional aspects important to consider when assessing by-product dynamics: linked supply risk of the by-product with the base/host metal sources, recovery of the by-product content available, and revenues of the by-product relative to the main product. The study includes an estimate for each of these additional aspects (see Table 28 in (Chapman et al. 2013)). However, a method illustrating how all these estimates shall be combined to estimate the potential risk supply of by-products is not included in (Chapman et al. 2013).

The study distinguishes between major and minor by-products. Major by-products include cobalt, gold, molybdenum, palladium, silver, and possibly tantalum. They are characterized by having own primary production infrastructure, recovery efficiencies over 60% and representing an important source of revenue, often considerably greater than 10%. Minor by-products refer to gallium, germanium, hafnium, indium, rhenium, selenium and tellurium. These have very limited own production infrastructure, lower

recovery efficiencies (sometimes 40%) and represent small contribution to revenues, typically less 5%.

Other additional risks of by-product metals mentioned are the small market size, concentrated world production, price volatility, and complexity of their refining. The assessment concludes by saying that good material-to-material knowledge is required to understand distinction between by-product metals.

5.6.3 Analysis

With respect to its potential to expand the range of supply risk factors, *by-production dynamics* would bring in a specific element of *economic/strategic/market* nature.

However, the role of by-products as supply risk factor with respect to criticality is complex. (Hagelüken and Meskers 2010) used a system approach, similar to that of (Verhoef et al. 2004), to discuss about the complexity of the supply of precious and special metals, which were regarded to be derived mostly from coupled production. The paper also discusses about two types of potential scarcities in the supply of minor metals: temporary and structural/technical. Temporary scarcity refers to the time lag between increase in demand and increase of metal supply (this can apply also to major metals). Structural or technical scarcity can occur due to inefficiencies in production or inadequate technology leading to high losses. The latest are most likely to occur for minor metals because technologies are optimized to obtain the greatest recovery yields of major metals, while by-product are generally only considered if they can be extracted economically, otherwise they are targeted as impurities which drive up production costs. Both potential supply risks can be mitigated for primary production by improving information about ore ratios of by-product in main deposits, technical efficiency of primary by-product recovery, optimal supply ratio major to minor metals, and developing further technologies to improve by-product recovery, and the existing processes. A detailed discussion about co-product supply for rare earth elements (REE) is done by Binnemans and colleagues (Binnemans et al. 2013). They argued that the availability of REEs does not depend solely on production volumes, but also on the natural abundance of individual REEs, thus their production dynamics. The actual situation is in fact, far from a perfect balance between the demand and supply of all REE elements as result of differences in demand due to technological evolutions in applications. (Fizaine 2013) analysed minor metals that are also by-products in order to determine if the link with the main/host metal can threaten the clean technology development illustrating the example of photovoltaics.

Metal by-products complicate the process of recovery of the major metal. Technology and metal treatment infrastructures are not designed to optimize the recovery of minor metals, and in some cases the choice of technology used to extract the main metal has also an impact on the recovery yield of the by-product metal. Apparently up to now, by-product metal production seems relatively independent from main metals as their production remains largely below their potential supply.

5.6.4 Concluding remarks on by-production

For *By-production dynamics*, the following items are derived:

- The supply of raw materials that are produced as by-products may have increased risks: there are risks associated to their supply chain similar to other raw materials. In addition, they may suffer supply risk as kind of collateral

damage of supply risks of the carrier raw materials: supply risks and disruptions of the carrier raw materials may directly result in additional supply risks and disruptions for the by-product raw material;

- On the other hand, raw materials produced as by-products may have easy extra supply, as they may be actually weakly recovered because of current limited demand or current low prices. This "buffer" may result in a lower risk of supply for raw material by-products versus main raw materials.

Future Research: With the above reasoning, the following can be explored towards the introduction of by-production dynamics as additional influence in the calculations in the future:

(1) Identify if the raw material is predominantly sourced as carrier or as by-product raw material.

(2) In case it is sourced predominantly as main/carrier raw material, e.g., above a threshold of 50% of global production, just apply the HHI_{WGI} of the raw material as such.

(3) In case the raw material is sourced predominantly as by-product, e.g. above a threshold of 50% of its global production, then calculate the HHI_{WGI} as a result of the supply risks associated to both of these of the by-product raw material and its host carrier raw materials as follows:

$$HHI_{WGI} = (HHI_{WGI})_{BP} + \sum_{i=1}^j (CM_i \cdot [HHI_{WGI}]_i) - UNR$$

where (HHI_{WGI})_{BP} is the HHI_{WGI} of the by-product; CM_i is the fraction of the supply of the by-product associated to carrier material i; and [HHI_{WGI}]_i is the HHI_{WGI} of carrier material i; and j is the number of carrier materials where the by-product is associated with. UNR represents a reduction in the risk because of the potential of unrecovered raw material (URM); however as the information to feed quantify UNR lacks today, in best case it may be estimated by expert judgement in a semi-quantitative scale (e.g. 5 classes resulting in 5 figures).

(4) As an alternative, the supply risk of by-products may be modelled relying on the supply risk of the carrier raw materials, but accommodated for the level of the recovery (low recovery today means a 'buffer' decreasing the supply risk):

$$HHI_{WGI} = \sum_{i=1}^j (PROD.SHARE_i \times RECOVERY_i \times HHI_{WGI,i})$$

with HHI_{WGI} the supply risk factor for the by-product, HHI_{WGI} the risk factor of the carrier raw material I, RECOVERY_i the actual recovery of the by-product in mining at carrier raw material i, PROD. SHARE_i the production share of the by-product from the host metal i, and j the overall carrier materials where the by-product is recovered.

5.7 End use competition

5.7.1 Summary

In several cases the same biotic material can be used for energy, food or materials production (e.g., wood for energy, wooden products, or paper). In these cases, different end use markets compete for the availability of the same biotic resource. In the context of the EU criticality methodology (focused only on non-food and non-energy uses) end use competition can affect the supply of biotic materials for non-food and non-energy applications.

5.7.2 Analysis

It is possible to obtain the annual end use distribution of the biotic materials in the EU (Chapman et al. 2013). However, in order to translate end use competition on the supply risk of biotic materials, for non-food and non-energy application, projections on the increase of biotic materials demand for these other applications would be necessary. At the moment the criticality methodology does not consider any influence of demand disturbances in the risk supply; therefore with the present methodology it is difficult to introduce parameters able to infer a correlation between end use competition and risk of supply.

For woody biomass, the competition between energy and material uses is very important and is increasing. According with the projections of the EUwood project (Mantau et al. 2010) in 2010 458 million m³ of wood were consumed for materials production in Europe, from this consumption 42.9% were used in the sawmill industry, 31.3% in the pulp industry, 20.2% in to produce panels, 2.5% for the production of veneer & plywood and 3.2% for other material uses³¹. The same study estimates a continuous increase of wood production for material uses in Europe achieving 619.8 million m³ in 2030. This increase will compete with a faster rise of wood demand for bioenergy from 346 million m³ in 2010 to 752 million m³ in 2030, as a consequence of the existing political incentives in the bioenergy sector (e.g., the Renewable Energy Directive). This competition may lead to supply shortage in the EU.

Due to the importance of this issue different studies are being developed to quantify biomass availability (not only woody biomass) together with biomass uses and potential uses, this is the case of the EUWood project and the JRC work on biomass supply and demand that started in 2015 and will have a EU28 and worldwide scope. These studies account also for waste streams (e.g. waste wood fibres) that may be re-used (cascade use of biomass) to decrease the end use competition between several end use sectors (Mantau 2015).

³¹ Please note that the study by (Mantau et al. 2010) may include some double-counting of wood uses.

5.7.3 Concluding remarks on end use competition

In the revised methodology:

End use competition is a very important aspect that may cause disturbances of biotic materials supply for non-food and non-energy uses due to disturbances in the demand for biotic materials, e.g. increase demand of biotic materials for bio-energy which competes with the demand for material production (which is the focus of the EU criticality methodology).

With the current methodology it may be difficult to incorporate end use competition, since the demand component is not directly taken into account in the methodology (demand-driven disruptions are considered to be part of an analysis of resilience).

End use competition in the material fact sheets: information on distribution of biotic materials end uses within the EU between: energy, food/feed and bio-based products should be included in the material fiches.

Future work needed: Further developments may arise with information being developed in biomass availability studies.

Note that economic issues related to biotics are currently split under “land use competition” and “end use competition”. Separate or joint discussion might be dealt with in future research.

5.8 Environmental and social considerations

5.8.1 Summary

Environmental and social implications can occur along all life cycle stages of both abiotic and biotic raw materials. Different indicators and modelling approaches exist that can help to account for both influences in the criticality assessment. These include modelling tools such as life cycle assessment (LCA) to consider the life cycle wide environmental implications of raw materials and product, and a number of indicators and composite indices to consider issues such as ethical sourcing, safety at work, and issues of public acceptance. This chapter provides a brief review of these additional aspects and an outlook to possible future work that would allow increased integration of environmental and social implications into the criticality framework.

5.8.2 Introduction

The EC criticality 2010 report included the environmental country risk (EM) in the assessment of supply risk using the Yale Environmental Performance Index (EPI)³² (EC 2010). EM considers that measures might be taken by countries with the intention of protecting the environment and by doing so endangering the supply of raw materials to the European Union. However, using this approach practically did not make any contribution to determining the list of critical raw materials, since all materials with critical EM values had already critical values for the governance-related component of supply risk.

The EPI consist of indicators measuring countries' performance on high-priority environmental issues in two areas: protection of human health and protection of ecosystems. EPI values range between 0 and 100 and use a proximity-to-target approach, i.e., the closer a value is to 100, the closer the country is to the considered target. Targets depict the desired value of environmental indicators, and can be based on international or national policies, but also on thresholds derived from scientific knowledge. For its use in the supply risk formula, EPI values were rescaled to 0 - 10 values and reversed so that the lowest value corresponds to the highest original value of the index, i.e., a good environmental performance, which corresponds to the lowest risk. This means that countries with a lower environmental performance (environmental state further away from reference targets) will have a higher supply risk.

However, EPI was eventually not included in the 2014 criticality report (EC 2014), because of "inconsistencies between the environmental performance in the mining sector of relevant producing countries and the EPI indicator values". The Ad hoc Working Group on Defining Critical Raw Materials subsequently decided to use the World Governance Index (WGI) for assessing the supply risk of all raw materials assessed.

However, EPI was discussed in the context of low environmental standards in the 2013 criticality study (Chapman et al. 2013).

Apart from the use of EPI, the 2010 study considered also the possibility of applying the Life Cycle Assessment (LCA) data and modelling approach to incorporate the environmental impact of raw materials in EM. However, this approach was not followed

³² <http://epi.yale.edu/>

due to: (1) data limitations, which could not guarantee the universal application of the methodology³³; (2) the fact that different quantities of material would be needed to fulfil a specific functional unit was found to make comparability between materials difficult and lead to erroneous conclusions; (3) available data did not represent a “cradle-to-grave” but a “cradle-to gate” approach. In addition, the link of such an approach to the risk of supply was not totally straightforward.

More recently, the 2013 report (Chapman et al. 2013) highlighted environmental regulation as one of the additional (end-use related) influences that are worth to be considered. This referred particularly to two legislation elements that could have an impact on the raw materials markets: the Registration, Evaluation, Authorisation and Restriction of Chemicals (REACH) regulation, and the Classification, Labelling and Packaging (CLP) regulation for substances and mixtures. However, this aspect was not included in the methodology since it requires a wider understanding of the supply chains.

Finally, environmental considerations were embodied in two of the mining governance approaches analysed within the additional influences section in the 2013 study –the Policy Potential Index (PPI) and Resource Governance Index (RGI) further discussed in section 3.3.

Social considerations (e.g. social conflicts derived from bad labour conditions, regulations of ethical sourcing) were not included in the 2010 and 2013 criticality studies explicitly (EC 2010; Chapman et al. 2013). There, the use of WGI embeds partially the potential risk associated to social problems in the country, particularly through the dimensions Political Stability and Absence of Violence/Terrorism³⁴ (PV), and Rule of Law³⁵ (RL). However, these WGI dimensions do not mirror problems that could emerge specifically from the raw materials sourcing activities that might put supply risk at stake. Social considerations were embodied in two of the mining governance approaches analysed within the additional influences section in the 2013 study (PPI and RGI) (Chapman et al. 2013). It is however important to highlight that both environmental and social considerations can also have a high impact on biotic materials supply.

5.8.3 Analysis

With respect to the broader coverage of supply risk factors of different nature, *environmental and social considerations* fit into regulatory/social supply risk factors and could be the first explicit factors in this type of risk factors.

5.8.3.1 Environmental considerations

From screening the literature, one type of approach was found in the literature review that can be considered relevant to the scope of this criticality study: the possible

³³ No LCI data could be found for beryllium, diatomite, germanium, niobium, and rhenium. A review of available metals LCI data is provided, e.g., in (Nuss and Eckelman 2014).

³⁴ Capturing perceptions of the likelihood that the government will be destabilized or overthrown by unconstitutional or violent means, including politically-motivated violence and terrorism.

³⁵ Capturing perceptions of the extent to which agents have confidence in and abide by the rules of society, and in particular the quality of contract enforcement, property rights, the police, and the courts, as well as the likelihood of crime and violence

development of environmental regulation that might increase the supply risk. This might be based on limits to products (end-use) because of materials' toxicity, or limits to activities or materials because of their high environmental impact. The first situation, the impact of end-uses was analysed as an additional influence in the 2013 study. There, two EU end-use policy frameworks were detailed and it was concluded that this could not be embedded in the methodology since a *wider understanding of the supply chains* would be required. A way of overcoming this complexity would be to use the toxicity of materials as a proxy positively correlated to the supply risk, as it was considered by the (NEDO 2009) study which, focusing on rare earths, proposed toxicity of materials as a driver of governmental regulation that could pose a supply risk in Japan. LCA data could be used to provide indicators of the pressures/burdens of a product's life cycle associated with toxicity. Alternatively, other types of impacts could be addressed and adapted to the often changing environmental policy targets. Examples include the consideration of the global warming potential and total material requirement of materials included as a risk component in the study by (Morley and Eatherley 2008). The EPI approach studied in the EC 2010 report (EC 2010) would be a specific type of environmental regulation approach: values of the EPI reflect the risk of further environmental regulation based on the environmental status in the country, rather than on the impact of materials. This index, which uses a distance-to target approach, which measures the environmental status of several aspects as compared with a reference (desired) status. However this index did not have a crucial influence in determining criticality. Specific components of the EPI might be considered in order to include in the methodology only reference to the policies related to more risky environmental aspects. However this would be highly variable among countries and materials considered.

Apart from this, two other possible types of environmental considerations may be relevant that were not addressed in the methodologies reviewed: (1) the occurrence of natural disasters that could cause a disruption of the supply (this aspect is further discussed for biotics in section 5.9); (2) Scarcity of resources essential for the mining/harvesting activity (e.g. water). Natural disasters such as landslides, climate extreme events (e.g., hurricanes, cyclones, flooding) or earthquakes can be considered as environmental supply risk factors. Although they are not considered to be among the most relevant risk factors for the extraction of some materials (e.g. copper, nickel, lead and zinc- presentation by P. Willis, Oakdene Hollins, 2015), they might be worth to be considered for production locations where the occurrence of extreme events leading to supply disruption is high, especially if showing an increasing trend. Natural disasters may be of particular importance for biotic materials. The UNEP Global Risk Data Platform is referred to as the main data sources, which include data on both disasters (occurrence, frequency) and the (economic) risk associated to this type of phenomena.

With respect to scarcity of resources essential for material supply, pressures related to water availability are growing, making numerous industries vulnerable to water disruption. These pressures can directly threaten a company's production levels, profit margins, and even "license to operate" in water-stressed areas. Trends show that water scarcity is already a raising problem and is already a limiting factor in some areas. In this context, indicators on water debt/stress might be considered. An example would be the Water Exploitation Index (currently available for Europe), or the water stress by country by the World Resources Institute (Figure 33), which measures the pressure on water by comparing withdraw and renewable water resources. The main limitation for the integration of this type of information in the methodology is the lack of indicators specifically reporting on the raw materials supply chain activities, in particular mining activities. In addition, water scarcity is difficult to approach given the highly differential sensitivities depending on location and type of material.

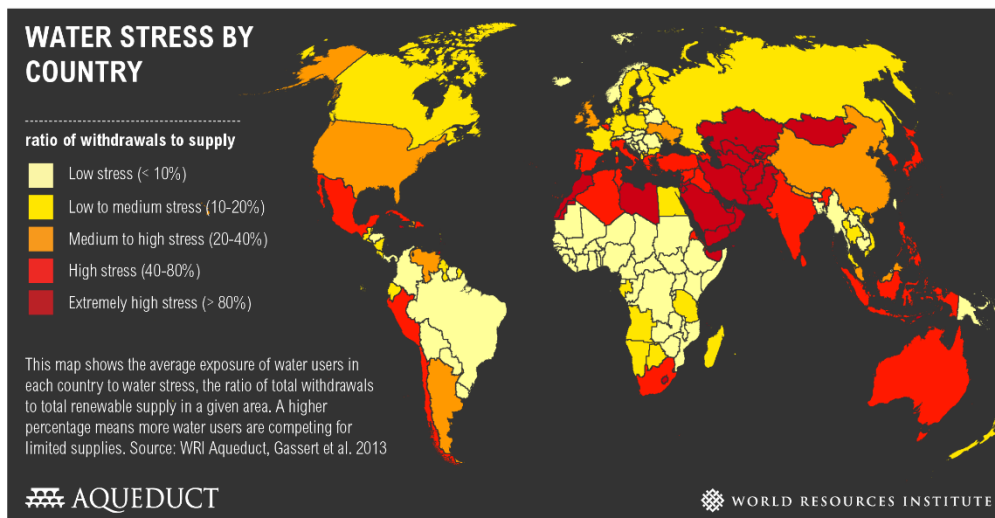

Figure 33 Water stress by country. Source: World Resources Institute (<http://www.wri.org/resources/charts-graphs/water-stress-country>).

5.8.3.2 Social considerations

Social problems, possibly caused by mining/harvesting and subsequent processing and refining activities, could lead to eventual disruption of supply. However, social aspects that could affect the supply in the short-term are quite absent in the criticality methodologies assessed. There the Human Development Index (HDI) is used as extractive activities-limitation proxy, which however will reflect only smooth, longer-term trends. The PPI as a whole does not add information as compared to the one contained already for governance in WGI.

Three further approaches were found valuable in this context:

Public acceptance of mining activities. Public acceptance is strongly linked to the notion of Social License to Operate, as a measure of not only the government but also "social permission" to the activity. For the mining sector public acceptance is a particular challenge, both for the operation of existing mines as for the development of new ones. An interesting data source has been found in the study carried out by the Eurobarometer (How companies influence our society: Citizen View", 2012), where the trust of citizens in the efforts of companies to behave responsible towards society, among other topics, were surveyed. Data are available for the EU and some countries outside Europe (Israel, Turkey, Brazil, US, China and India). Results for Mining and Oil & Gas Industry companies are displayed altogether, and show overall low levels of public acceptance of these sectors in Europe, while acceptance is generally higher in countries outside Europe. Although this is a relevant type of information and robust data source, coverage of countries outside the EU is very limited. Therefore it would be worth follow track of further developments of this type of Eurobarometer survey or similar approaches having a wider coverage.

Safety at work (mining). Bad working conditions at mining sites might lead to social protests that can lead to supply disruption, which can be quite extended in time (e.g. strikes in gold-copper mines Peru). A proxy to include this risk component in the methodology could be the use of the number of accidents/fatalities at the mining sites. There are two main international sources for data on injuries, which also show information at mining sector level: (1) European Statistics on Accidents at Work (ESAW), which collects the declarations of accidents at work at EU level, either to the public or

private specific insurance companies or to other relevant national authorities; (2) Database of the International Labour Organization (ILO, LABORSTA) which collects data on occupational injuries at international level. Data are disaggregated by economic sector, using the Standard Industrial Classification of all Economic Activities (ISIC-Rev.3). The inclusion of an indicator capable to depict this risk component would be valuable, but the potential in the criticality methodology appears still limited for three reasons. First, reporting systems vary among countries making robust comparability not possible. Second, data are missing for many countries (e.g. many African countries). Third, the probability of encountering social protest might depend on complex social factors such as the cultural-political background in the country, and not just injuries/fatalities rate. Therefore, and since currently such a robust approach is missing, it would be worth to explore further developments pointing in this direction.

Regulation of ethical sourcing. EU, US and international agreements impose limits to sourcing of raw materials from specific areas due to conflicts, might also lead to supply disruptions. In particular, in an EU context, some minerals are already under the conflict mineral legislative proposal which is currently in co-decision phase (tin, tantalum, tungsten and gold)³⁶. Another example, although applying for a mineral out of the scope of the criticality study, is the Kimberley Process³⁷. This process aims to stop trade of diamonds produced under conflict conditions in order to avoid financing these violent movements trying to undermine legitimate governments. It works through a certification scheme that can be followed by countries which met a set of requirements, in order to certify that shipments of diamonds are not coming from conflicts. Requirements to governments include, among other, to put in place specific legislation, establish export/import controls, data transparency, and prohibition to trade with countries not fulfilling the requirements.

5.8.4 Concluding remarks on environmental / social issues

For the environmental and social considerations, the following conclusions are drawn:

In the context of supply risk factors, environmental and social considerations should be further analysed as potential supply threatening factors, especially in the short-term.

Following this reasoning, approaches based just on the environmental impact of materials without linking to a possible (immediate) supply disruption are not considered to fit in the scope. Integration of broader environmental implications, e.g. relying on LCA (e.g., (Graedel et al. 2015; Nuss and Eckelman 2014)) may be valuable in a broader (environmental) sustainability viewpoint, but are clearly beyond the supply disruption risk issue in the criticality methodology.

Data reliability problems still limit a robust implementation. Further evolutions in the development of the quantification of the aforementioned items are to be followed. In particular, the Social License to Operate as concept may lead to quantitative data in the long term. Alternatively, ethical sourcing could be more easily integrated: this type of regulation has the capacity to restrict the list of sourcing countries.

³⁶ See, for example, <http://www.europarl.europa.eu/news/en/news-room/20150513IPR55318/Conflict-minerals-MEPs-ask-for-mandatory-certification-of-EU-importers>:

³⁷ <http://www.kimberleyprocess.com/>

In the revised methodology:

Environmental and social considerations that might lead to supply disruption are, to some extent, already indirectly embodied in WGI. In this study, we do not explicitly suggest to modify the current criticality methodology. However, because social and environmental implications are relevant across all stages of the raw materials supply chain and are relevant in the wider context of sustainable development, we recommend consideration of how to capture both in future studies.

Future Research: In view of environmental factors that may play a role as supply risk factor: three items have to be considered:

- (1) Immediate impacts like toxicity of materials;
- (2) Natural disasters –cyclones, floods, landslides;
- (3) Availability of natural resources, especially water, required for raw materials extraction and processing.

In a similar reasoning for social considerations, i.e. threats to supply, the following items have to be faced, essentially all linked to the Social License to Operate (SLO):

- (1) Public acceptance of (extraction) mining and further processing activities
- (2) Safety at work
- (3) Regulation of ethical sourcing.

Further analysis of environmental and social factors affecting biotic materials should be considered in future developments.

5.9 Natural disasters, fires, pests and diseases

5.9.1 Summary

Natural disasters, pests and diseases can impact the vitality of the biotic resources and cause important shortages of biotic materials supply. These events are important for the ecosystems dynamics and for presenting the biological diversity and regeneration of biotic resources. However, they can also have a highly destructive effect on, e.g., biotic materials, soil, and water resources. In this chapter, some of the natural disasters that have the potential to impact the supply risk of biotic materials are reviewed. We then provide a summary of some of the data sources that may be used in the future to assess these issues in the context of a criticality study. For example, it is recognised that climate change is intensifying the frequency, timing and severity of these impacts (Moore and Allard 2011), which in turn can lead to extreme effects on biotic resources. Climate change is responsible for increasing degradation of biotic material feedstocks, extinction risk, and shifting of tree species (and other biotic species) to other geographic areas (IPCC 2014; JRC 2015). However, the relationships between climate change, natural disasters and effects on biotic resources are still difficult to quantify.

5.9.2 Analyses

5.9.2.1 Natural disasters and fires

Natural disasters were mentioned in the previous section as an additional influence of supply risk within the environmental considerations. The number of natural disasters that can affect biotic materials supply is broader than for abiotic materials. According to FAO (FAO, 2011), natural disasters that can affect forest (and other biotic resources) can be divided in 5 categories of disturbances:

- Meteorological: cyclones and storms (wind, snow, ice, dust and sand);
- Climatological: drought;
- Hydrological: floods, avalanches and landslides;
- Geophysical: tsunamis, earthquakes and volcanic eruptions;
- Anthropogenic (not natural): fire, oil spills, air pollution and radioactive contamination.

Examples of such disturbances and their consequences on forests ecosystems are reviewed in FAO 2011. According with (Gardiner et al. 2011) in the last century wind storms damages in EU forests increased substantially, being responsible for more than 50% of the forests primary damages. These damages represented important economic losses in productive forests.

Another major effect on biotic supply may come from fires. According with FAO (FAO 2010a; Moore and Allard 2011; DG ENV 2015) some ecosystems are well adapted to frequent fires, both from natural (e.g. lightning) or human causes. However the majority of the forest ecosystems are negatively affected by wildfires. Around 1% of the world forest is believed to be lost in the world due to fires every year. Even if this number

seems low, fires can have huge impacts at a local level, with important losses that can represent more than 10% of a country forest area.

After a devastating event such as a wind storm or fire, the damages provoked in the forest (or other biotic resources) ecosystems may increase the vulnerability of the resources to further disturbances such as insect attacks and pathogens. This means that the degradation of the forests may continue for a long time even after the main disturbance, which adverse effects on the biotic materials supply.

Additionally, weak forest management can also influence the vulnerability of the forest to natural disasters, such as increasing flooding and landslides during cyclones, or the propagation of wildfires.

The FAO Global Forest Resource Assessment has information on forest areas disturbed by different events. However, the information suffers from poor reporting of the countries and therefore the data coverage is reduced. Regarding forests fires JRC has developed the European Forest Fire Information System (EFFIS) which provides information on forest fires in the pan-European region. It includes an enormous EU fire database and reports that are issued annually, with pos-evaluation of the EU fires (JRC 2013; Anon 2015).

Natural disasters or fire risk to the supply of biotic materials may be measured as a function of the disaster frequency and intensity, as well as the exposure and vulnerability of the biotic material to that disaster. This means that the supply can be affected especially when the supply is highly concentrated in one country or region frequently exposed to fires or natural disasters. UNEP/GRID-Geneva created the PREVIEW Global Risk Data Platform, which has spatial data information on natural hazards (collected from different databases). Using the information available in this platform it could enable the identification of risk areas frequently exposed to natural disasters. Combining this information with the location of the biotic resources will allow the identification of harvesting areas with high or low supply risk due to natural disasters.

Other sources of information for natural disasters include:

- The United Nations Office for Disasters Risk Reduction: <http://www.unisdr.org/we/inform/disaster-statistics>, <http://preview.grid.unep.ch/>.
- The JRC has also detailed spatial information on EU fires and tree species distribution in the EU <http://forest.jrc.ec.europa.eu/effis/>; The [European Forest Fire Information System \(EFFIS\)](#) in jointly managed by JRC and DG Environment.
- <http://forest.jrc.ec.europa.eu/efdac/applications/species-distribution/>.
- The Moderate Resolution Imaging Spectroradiometer form (MODIS, 2015) as geographic information on burned areas, available at: https://lpdaac.usgs.gov/dataset_discovery/modis/modis_products_table/mcd45a1.

5.9.2.2 Pests and diseases

Insect pests and pathogens can also affect the supply of biotic materials. The quality and production yield could be affected and, depending on the severity of the biological attack (insect or disease) the biotic material availability can decrease or completely disappear. Two factors may contribute to the increase of pests and diseases outbreaks: climate change and global trade of biotic products.

The analyses of the risk of supply due to pests and diseases should be done case by case in order to identify the possible threats and vulnerability of the biotic materials.

Example: As an example natural rubber supply may be highly affected by *Microcyclus ulei* (South American leaf blight). *Microcyclus ulei* is a fungal disease that is able to destroy young rubber trees. The impact of such disease was already demonstrated in South and Central America destroying the attempts made to increase the production of natural rubber in those regions. Until the moment no records of such disease were reported in Asia, in the countries were the majority of natural rubber is produced (see Figure below). However, several authors indicate that the low genetic variety of the Asian rubber plantations (the majority of the production comes from Brazilian tree clones, susceptible to the disease) makes them highly sensitive to this disease. If the disease would spread to Asia the impacts on natural rubber production could be devastating (ISC 2015).

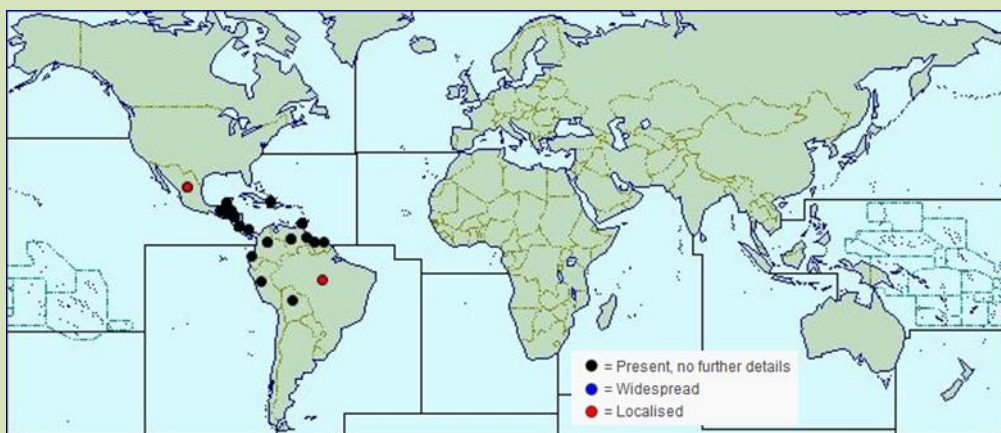

Figure: Worldwide distribution of *Microcyclus ulei*. Source: Invasive species compendium <http://www.cabi.org/isc/search/?q=&types=7,19&sort=DateDesc>.

Several sources of information may provide qualitative data on existing pests and diseases as well as their target hosts and outbreaks; more quantitative data is still missing. Again a global overview of forests pests and diseases is provided by (FAO 2010a) and in <http://www.fao.org/forestry/43795/en/>. However, the coverage of this information is still low representing only 53% of the total forest area.

Sources of information on geographic distribution of pests and diseases include also:

- The **database on quarantine pests** of the European and Mediterranean Plant Protection Organization (EPPO, 2015) <http://www.eppo.int/DATABASES/pqr/pqr.htm>;
- The Invasive species compendium <http://www.cabi.org/isc/search/?q=&types=7,19&sort=DateDesc>.

The risk and impacts of pests and diseases may be minimised by proper management of the resources, e.g. sustainable forest management includes measures for protection against pests and diseases. This underlines again the importance of including a component of sustainable management in the methodology.

5.9.3 Concluding remarks on natural disasters, etc.

In the revised methodology:

Natural disasters, pests and diseases can cause important shortages of biotic materials supply. The assessment of such influences may be considered in a more detailed evaluation and included in the material factsheets.

No changes to the current revised methodology were made.

Natural disasters pests and diseases in the material fact sheets: Geographic information on the occurrences of these events may be used to identify frequently exposed areas, which have higher supply risk compared with areas where the exposure is low. The vulnerability of the biotic materials to each event should be taken into account in such an assessment. For cases where vulnerability of a biotic material to a given disturbance is known to be high, information should be added to the material fiches.

Additionally, the vulnerability of the biotic materials to natural disasters, fires, pests and diseases may be decreased by sustainable management of the biotic resource. This highlights the importance of sustainable management of biotic materials

6 ANALYSIS OF DATA AVAILABILITY AND QUALITY

6.1 Summary

This section is intended to give an overview of the data sources and their content, required for the application of the revised criticality methodology. A methodology for assessment of data quality and completeness is also provided in **Annex**. Data sources for 58 raw materials, including abiotic (metals, construction, and industrial minerals) and biotic materials (pulpwood and sawn wood) are screened.

6.2 Data needs for the updated methodology

The following data/parameters are utilized in the methodology:

Table 19 Data used in the updated methodology

Abbreviation	Indicators	Source
A_{is}	Share of consumption of a material i in a given end-use sector s	To be assessed (instructions in WP1)
Q_s	Added value of NACE Rev 2-2 digit sector	Eurostat (instructions in WP1)
EI_i	Economic importance of a raw material i	To be calculated
T	Export barriers / trade agreements	OECD database (instructions in WP1)
WGI_c	Worldwide Governance Indicators for a country c	Worldbank
HHI_{WGI}	Herfindahl-Hirschmann-Index for (in)stability and level of concentration of producing countries	To be calculated
S_{ic}	Share of country c in the world production of material i (global supply)	To be assessed
$SI_{EI/SR}$	Substitution Index for material i in each end-use/sector s	To be assessed/calculated (instructions in WP1)
ρ_i	Recycling rate from old scrap for material i	To be assessed/calculated
IR	Import reliance	To be calculated
GS	Global Supply	BGS
$CONS_i$	EU Consumption for material i	Eurostat
DP	Domestic Production	BGS
I/E	Import/Export to/from EU	BGS
SR_i	Supply Risk of a raw material i	To be calculated

6.3 Data identification

The following procedure was followed to identify the data contained in an excel file, called hereafter **Data File**³⁸:

- Identification of potential data suppliers, mainly through the review of the various criticality methodologies, but also via web searches for specific data;
- Identification of potentially relevant datasets, by screening their description and content;
- Analysis of the relevant datasets for each material;
- Compilation of data of interest across all datasets - done per indicator and per material.

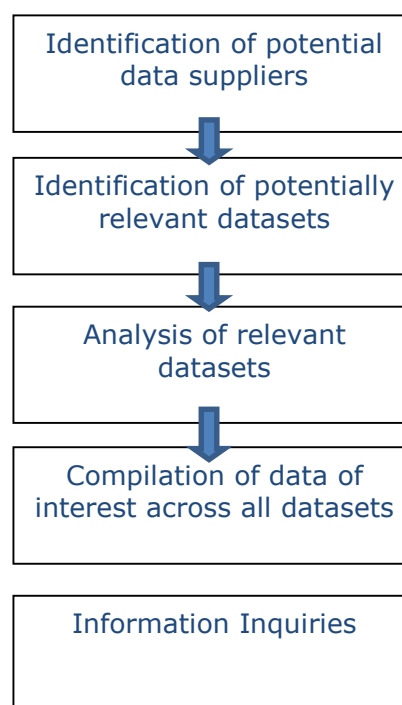

In addition, requests for relevant data sources, databases and specific missing data were made to different interest groups/associations. The provided information, mainly in the form of links to websites, has been included in the database. Additional data supplied as independent files are specifically listed in the database Data File.

6.4 Data description

The information on different data sources (DS) is structured in the Data File including 6 worksheets whose content is explained in details below.

Table 20 Data description

Worksheet	Description
"Overview of separate files"	A description of individual files sent by groups/ organisations / associations is given. A unique reference – SF [1] to [n] was allocated to each file. Some of them, considered most useful are inserted also in the sheet "Relevant references screened".
"Overview of other DSs available"	A list of datasets available is provided. These were either not screened - and highlighted as such - or screened but found to be of no major relevance for this exercise. These include factsheets and statistics available from websites, books, online catalogues and reports. The data set title, description and hyperlink to the website are identified. Alongside, the type of available data is shortly indicated. If not freely available the price of the dataset is given. The data is sorted in ascending order is linked to the data providers list in the first column. It should be noted that the same provider may be responsible for more than one entry.

³⁸ Available for download at <http://rmis.jrc.ec.europa.eu/>

"Overview of publications"	A list of selected scientific articles and books is given. Brief details about the respective content are included.
"Overview of data providers"	The entries correspond to Institutions/ Organizations/ Companies/ Agencies/ Associations responsible for the elaboration of a dataset or simply for its distribution and dissemination. The worksheet includes names and links of data providers to which a reference number (Pro ₁ ...Pro _n) has been allocated, specified in the first sorted column. A description of provider's activities and focus is given. Relevant additional links to the provider are included. Data providers identified but not yet screened are highlighted as such.
"Relevant references screened"	This worksheet displays the same information as the "Overview of other DSs available" worksheet. The difference is that only the datasets relevant to the revised methodology are compiled. For each dataset a unique reference – [1] to [n] - is allocated, specified in the second sorted column.
"Data availability in DSs"	This worksheet summarizes the availability of pertinent data per material and per indicator. In addition, when available, the year of the data as well as data dis-aggregation level (e.g., REE or PGM taken as a group) is also referenced in the worksheet.

6.5 Navigating through the data file

To find/extract specific information in the Data File (see Table 19), the following steps should be done:

Step 1: **Browse the "Data availability in DSs"** sheet to explore databases related to each indicator for the considered materials. Identify the dataset references.

Step 2: **Browse through the "Dataset reference"** column of the "Relevant references screened" and pull out the links to specific datasets for each material.

Note 1: A description of the data set contents is given.

Note 2: If not publically available, the dataset price is indicated.

Note 3: The data provider reference is linked to each database (Pro₁ to Pro_n). The provider website along with a description of its activities is given in the "Overview of data providers" (see column headers).

To search for additional data beyond the methodology, the following steps are required:

Step 1: **Browse the "Relevant references screened" or the "Overview other DSs available"** sheets. Note the records subordinated to the data column "Additional data available" and/or insert a search using the Excel find tool. Use keywords for accessing specific information or enter the material name. Use also this tool to analyse the dataset using any of the mentioned parameters.

Note 1: Information listed under the column "Additional data available" encompasses the following data: resources, reserves, exploration and mining projects, market trends, prices and forecasts for supply and demand.

Step 2: **Follow the link to the data set.**

6.6 Data availability overview

The Data File contains information on 313 data providers were identified, of which, 122 were thoroughly screened.

244 datasets were documented in the Data File, of which, 76 were considered most useful to address the revised methodology indicators. These datasets already provide approximately 85% of the information needed to perform the methodology.

Table 21 gives an overview of data availability for each indicator. To make it easy-to-read, different colours are used to illustrate data availability for the considered materials.

Key to color scale in table 3	AVAILABLE (k)	Not available yet (l)	Incomplete (m)

Where:

(k) Datasets screened so far contain relevant information to access the indicator. The number of useful datasets is specified in the table itself.

(l) Further dataset screening is needed for data availability clarification.

(m) Information available is not ample enough to consistently derive the indicator.

Table 21 Data availability

Materials	A_{is}	S_{ic}	SI	ρ_i	EU CONS _i
Aluminium	4	4		4	6
Antimony	2	3	3	2	5
Barium				1	
Barytes	1	4	1		3
Bauxite		3			3
Bentonite	1	2		1	3
Beryllium	3	5	5	4	2
Bismuth		3		1	4
Borate	2	3		1	5
Boron				1	
Calcium					
Cerium (*1)	5	4	3	4	5
Chromium	3	3	1	3	4
Clays	1	2		1	2
Cobalt	9	7	4	6	6
Coking coal	2	3	1	1	2
Copper	5	3	2	3	7
Diatomite	1	2	1		3
Dysprosium (*2)	7	5	3	6	6
Erbium (*2)	7	5	3	6	6
Europium (*2)	7	5	3	6	6
Feldspar	1	2		1	3
Fluorspar	2	4	3	1	5
Gadolinium (*2)	6	4	3	5	5
Gallium	3	3	4	6	2
Germanium	4	3	3	5	3

Materials	A _{IS}	S _{IC}	SI	ρ _i	EU CONS _i
Gold	2	3		3	3
Amorphous graphite	4	6	4	3	4
Gypsum		3		2	3
Hafnium	1	1		1	
Helium					
Holmium (*2)	6	4	3	5	5
Indium (a)	3	2	3	6	4
Iridium (')	1	1	2	1	4
Iron	1	5		2	5
Lanthanum (*1)	6	4	3	5	5
Limestone	2	1	3	1	2
Lithium (a)	5	5	2	5	5
Lutetium (*2)	6	4	3	5	5
Magnesia					2
Magnesite	1	3	1	1	4
Magnesium	6	4	3	3	4
Manganese	1	2		1	4
Molybdenum	2	2	1	2	4
Neodymium (*1)	6	5	3	6	6
Nickel	3	4	1	2	4
Niobium	2	4	2	2	4
Osmium (')		1	2	1	4
Palladium (')	5	5	2	5	5
Phosphorus	2	1	1	3	1
Phosphate rock	3	5		1	5
Platinum (')	6	5	3	8	5
Potash	1	3	1	1	4
Praseodymium (*1)	6	4	3	5	5
Pulpwood		1		1	2
Rhenium	1	3		1	3
Rhodium (')	5	4	3	7	5
Ruthenium (')	2	1	2	2	2
Samarium (*1)	6	4	3	5	5
Sawn wood		1			2
Scandium (*)	6	4	3	2	5
Selenium	1	2		1	3
Silica sand	1			1	3
Silicon	3	3	1	2	3
Silver	3	3	1	3	3
Sulfur		2			3
Tantalum	5	6	2	5	4
Talc	1	2		1	3
Tellurium	3	2	1	3	3
Terbium (*2)	6	5	3	6	6
Thulium (*2)	6	4	3	5	5
Tin	1	2		1	4
Titanium	1	2		1	4
Tungsten (a)	5	4	4	3	5
Vanadium	1	2	1	2	4
Ytterbium (*2)	6	4	3	5	5
Yttrium (*2)	6	4	3	6	6
Zinc	3	3		2	5

(a) Raw materials selected as case studies.

(*) Rare earth elements group (REE): (*1) metals assigned to the light REE group (LREE), (*2) metals assigned to the heavy REE group (HREE) – note that different subdivisions may be used. (') Platinum group metals (PGM).

6.7 Proposals for Recommendations on datasets to be used

JRC proposal for Recommendations on datasets to be used are in some cases provided in sections 2 (economic importance) and 3 (supply risk). For Recycling³⁹, the data sources include:

- 'Study on Data for a Raw Material System Analysis: Roadmap and Test of the Fully Operational MSA for Raw Materials', from (BIO by Deloitte 2015) (prepared for the European Commission, DG GROW) – listed with the reference [MSA]. 'Recycling rates of metals: A status report', from (UNEP 2011) - listed in the database with the reference number [23];

-

For global supply and import/export statistics the British Geological Survey (BGS) provides high resolution data, covering a significant number of materials. Production and trade statistic data, by country and material, are compiled on a yearly basis using long established procedures and an existing network of contacts. Trade data is assessed against the United Nations commodity trade web-database and the Eurostat's online database. The following datasets are referenced:

- 'World Mineral Production 2009-2013' - listed with the reference number [2].
- 'World Mineral Statistics Data' – listed with the reference number [3].
- 'European Mineral Statistics 2009-2013' - listed with the reference number [4].

Other datasets quoted in the summary table "Data availability in DSs" should provide additional materials coverage and can be used for quality assurance of the available data or implementation of quality control procedures.

BGS European Mineral Statistics database - Notes on type of data availability⁴⁰:

(1) Statistics on metal production concern mine and refinery production, normally separately shown (e.g., aluminium/bauxite, cobalt, copper, iron, nickel, tin, and zinc). If not specified otherwise, metal production statistics relate to metal recovered from both domestic and imported materials, whether primary or secondary.

(2) Metal trade statistics usually include under the term metal unwrought and wrought forms, powder, alloys, waste and scrap (antimony, bismuth, cadmium, cobalt, manganese, molybdenum, tantalum-niobium, titanium, tungsten, and vanadium). Waste & scrap is only separately shown for: aluminium, copper, gold, iron, nickel, platinum metals (taken as a group), silver, tin, vanadium (to some extent) and zinc. Trade tables of other metals include only unwrought forms under the term 'metal'.

(3) Metal traded in ferro-alloy form is included under Iron Steel and ferro-alloys (e.g., aluminium, chromium, manganese, molybdenum, nickel, tantalum and niobium, titanium, tungsten, vanadium).

6.8 Data gaps

The estimated percentage of missing data in the Data File is about 15%.

Data gaps or insufficient data coverage is most visible for the following particular cases:

- No information found so far for calcium and helium.
- Data gaps on 3 to 4 indicators for barium, boron, magnesia, sawn wood and sulfur.
- Insufficient information available for amorphous graphite; most data relates to natural graphite which includes crystalline, flake and amorphous forms.
- Insufficient information available for silica sand; statistics on aggregates include sands and crushed rock however no distinction between construction sands and special sand for industries uses (e.g. glass) is provided.
- Available information for clay mainly concerns kaolin (the market name for the mineral kaolinite).
- Scarce information for magnesia; when available, concerning data sets do not distinguish between magnesia and magnesite. Magnesia is a semi-processed material which can be produced from both magnesite and a combination of seawater and dolomite.
- In some cases data concerning coal does not distinguish coking coal (a type of bituminous coal) from the other forms.
- With the exception of cerium, discrete information concerning individual materials belonging to the rare earth elements is not generally available. Disaggregated data for dysprosium, erbium, europium, neodymium, terbium and yttrium are presented in BIO Deloitte's Material System Analysis study. Few other listed datasets provide partially disaggregated data. Amongst the PGMs, individual data is more readily available for palladium, platinum, and rhodium.

6.9 Quality assessment of the data sources

Matrix approach is proposed to assess the data quality in order to make decision for their further use. A tailored matrix incorporating different criteria such as:

- Type of data (public, corporate)
- Data geographical coverage
- Data completeness (in terms of supply chain coverage and usefulness for the methodology)
- Time resolution / frequency of update

- Level of disaggregation*
- Additional data availability (forecast, market size etc.)
- Data access (cost and conditions)

* *Level of data disaggregation should be understood as data disaggregation in terms of:*

- Single material data or group of materials (e.g. REE, PGM)
- Minerals/ores or concentrates/metal content
- Supply chain level – in some cases difference is not made between refined and primary material, which can distort the final results.

Each of the chosen criteria is then scored on a scale from 0 to 2: 0 being low quality data (limited coverage, very random updates etc.) and 2 being high quality data (very strong coverage, time series available, official statistical source etc.).

Through summation of the scores assigned for each of the parameters, the final quality score is calculated for each data source:

Max score 14 = very high quality data

Min score 0 = very poor quality data

Scores between **0 and 4** = **Low quality data**

Scores between **5 and 9** = **Medium quality data**

Scores between **10 and 14** = **High quality data**

Quality assessment of 3 datasets chosen for the three materials

1) *Panorama 2010 du marché du Lithium* (Lithium data) (Labbé and Daw 2012)

2) *Materials critical to the energy industry: An introduction* (Indium data) (Achzet et al. 2011)

3) *British Geological Survey – European Mineral Statistics* (Tungsten data) (BGS 2014)

The *European Mineral Statistics* and the *Panorama 2010 du marché du Lithium* report were evaluated as high quality data according to the proposed methodology.

The data offered in the *Materials critical to the energy industry: An introduction* scored as medium quality data.

The **evaluation tables** for these three datasets are given in the **Annex 2**.

7 THE USE OF THE LIST OF CRMs

7.1 Summary

This section provides an overview of the use of the EU Critical Raw Materials (CRMs) list by various public and private stakeholders, including Member States, regions, and industry. The information on similar criticality assessments undertaken by Member States, regions and other stakeholders (referred hereafter as respondents) and how this is used for strategic decisions was collected via survey and synthesised in the following chapter.

More specifically, the survey was intended to collect information on:

- Whether the respondents use the EU list of critical raw materials and if yes - does the EU list meet their needs;
- Which are the materials of common interest – current and future;
- Whether the EU list is used for decision making process and/or strategic planning activities, as well as setting up R&D activities;
- Whether the EC methodology was used as a reference by organisations which developed their own list;

The survey received broad audience (56 respondents in total) which clearly shows the engagement and interest of various organisations towards the raw materials policy in EU. The EU CRM list is used in a large part for strategic planning and decision making processes at both corporate and governmental level. In addition, we summarize a number of possible shortcomings of the EC criticality methodology as perceived by the survey participants. The chapter concludes with a detailed literature review of various organizations (companies, universities, government bodies, etc.) currently carrying out criticality assessments.

7.2 Survey respondents

56 organisations provided feedback through the survey. Several different organisation categories can be distinguished as indicated in Figure 34:

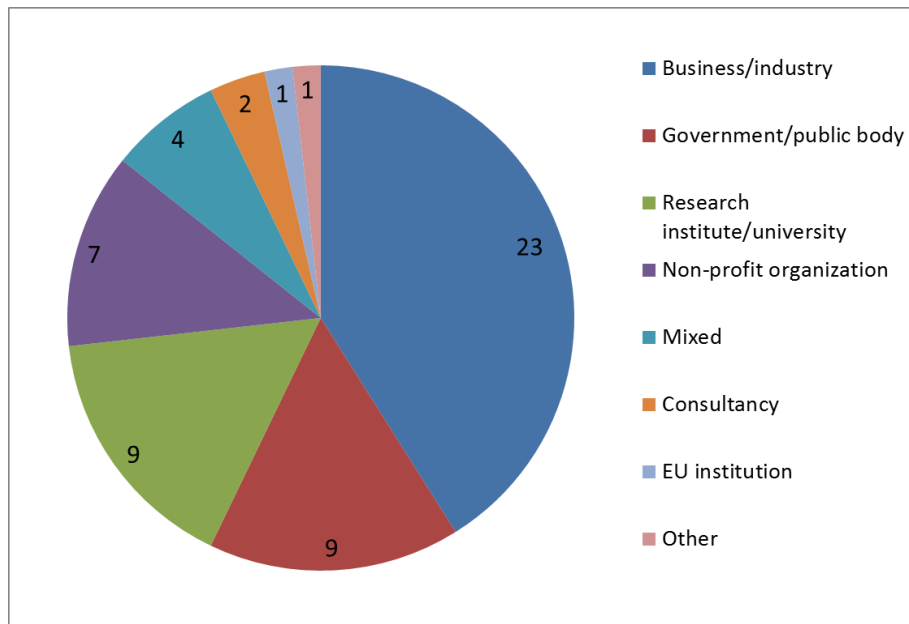

Figure 34 Overview of the surveyed organisations. Number figures in the pie chart refer to the number of survey respondents within each stakeholder category.

Around 41% of respondents were business/industry related organisations, followed by Government/public bodies and research institute/university – both at 16%.

Graphical representation of the survey outcome is presented further in the chapter for each particular question.

7.3 Survey results

Question 1: Are you aware of the (regular) publication of the Critical Raw Materials list by the European Commission?

9 out of 56 surveyed organisations were not aware about the regular publication of the EC CRM list. The majority of the organisations responding negatively are business/industry related (Figure 35).

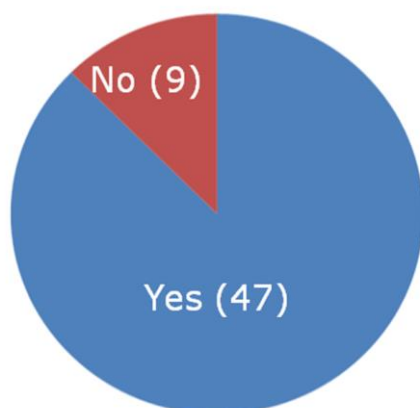

Figure 35 Survey responses to question 1.

Question 2: Do/did you use the EU list of critical raw materials?

6 out of 56 surveyed organisations, all of them business/industry related, declared that the list is not relevant to their needs (Figure 36). Twelve organisations did not disclose any information regarding the usage of the list.

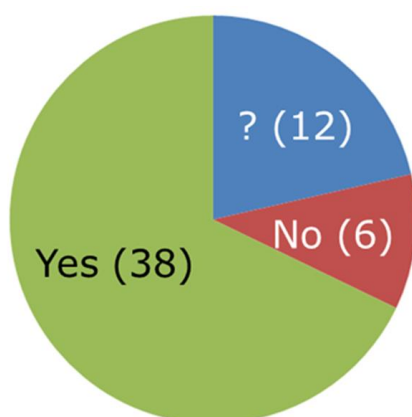

Figure 36 Survey responses to question 2.

The following was stated as reasons of not using the CRM list:

- The list is found too general by some stakeholders, not always covering the materials of interest;
- Some stakeholders do not use the list of CRMs or question the validity of the list because they challenge the definition of some RM (e.g. magnesite – magnesium);
- Some stakeholders use their own CRM list.

Among the organisations that gave a positive response (38 respondents), the following uses can be distinguished (Figure 37):

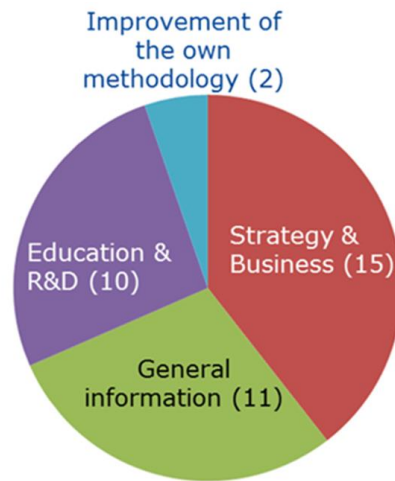

Figure 37 Survey responses to question 2 by organisation type.

Question 3: Materials for which the list was consulted

All CRMs were mentioned; the most quoted ones were Beryllium, Cobalt, REEs and PGMs (Figure 38 and Table 22).

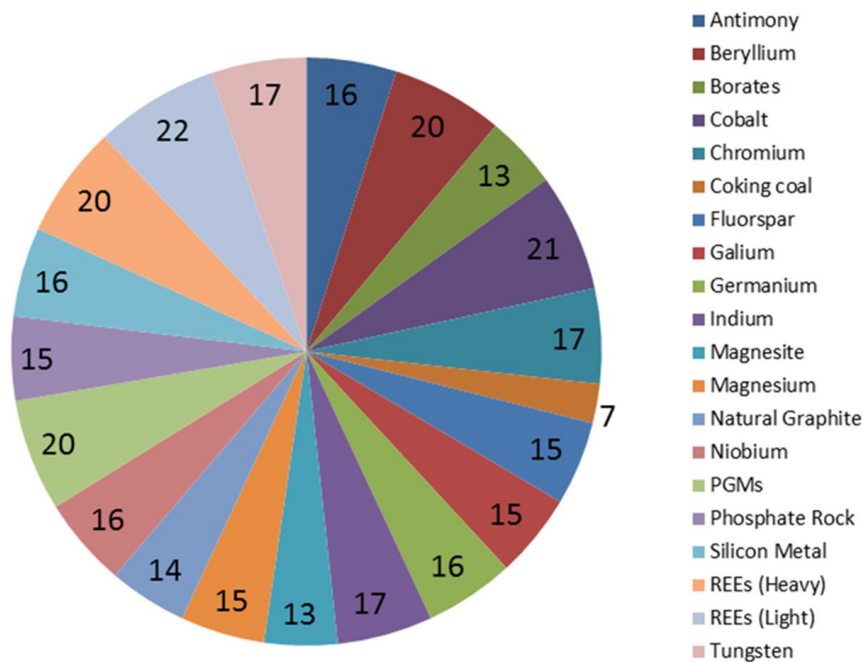

Figure 38 Survey responses to question 3.

Table 22 Survey responses to question 3.

Material	Number of quotes
REEs (Light)	22
Cobalt	21
REEs (Heavy)	20

Material	Number of quotes
PGMs	20
Beryllium	20
Indium	17
Tungsten	17
Chromium	17
Antimony	16
Niobium	16
Silicon metal	16
Germanium	16
Gallium	15
Fluorspar	15
Magnesium	15
Phosphate rock	15
Natural graphite	14
Magnesite	13
Borates	13
Cocking coal	7

Question 4: Does the EU list of critical raw materials meet the needs of your organisation?

44 out of 56 organisations responded the question. Most of the organisations declared partial coverage of their needs by the EU CRM list. Only 6 organisations – predominantly business/industry related - gave a negative statement (figure 39).

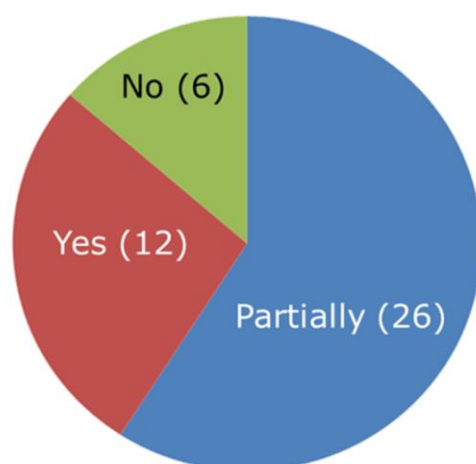

Figure 39 Survey responses to question 4.

Different organisations declared that the present EC list meets their needs. Details are given below:

Question 4.1: How the needs of the organisations are covered?

- Provides a good overview of the raw materials topic;
- Gives an approach to the raw materials' issues;
- Good guidelines for setting up targets;
- Highlight the importance of certain materials for the national economies;
- Provides guidance for advances within EU in relation to materials under concern;
- Underlines the importance of certain materials to the EU society.

Most of the organisations reported that the EU list meets only partially their needs. The following reasons were indicated in support of that statement:

Question 4.2: How the needs of the organisations are covered partially?

- The EU list does not reflect fully the reality in the different MS;
- Economic importance definition – all listed materials are of importance including many of the not listed supposedly non-critical raw materials ⁴¹;
- Supply risk definition - there is a trade issue for some materials rather than SR;
- Lack of good quality data - a problem on all scales, from global to EU to national;
- Dynamic approach, having in consideration scenarios of general shortage of supply should be adopted;
- Supply chain approach not reflected, as well as missing methodological flaws.

Question 4.3: Why the needs of the organisations are not covered?

Several points are given as a reason:

- Materials of interest not covered- often it is a matter of data quality;
- It does not offer alternative solutions to increase supply through removal of tariff lines, regulatory barriers on the use of some products;
- It does not give effective support to some EU industries;
- The report is too general in nature.

⁴¹ COM2014 (297) Communication from 26.05.2014: "It (the list) should help to incentivise the European production of critical raw materials and facilitate the launching of new mining activities. The list is also being used to help prioritise needs and actions. For example, it serves as a supporting element when negotiating trade agreements, challenging trade distortion measures or promoting research and innovation. Information on its use by Member States and industry is, however, very scarce. It is also worth emphasising that all raw materials, even if not classed as critical, are important.

Question 5: Which materials from the EU CRM list are of interest to your organisation?

The most quoted materials were Beryllium, Chromium, Cobalt, Germanium, Indium, Magnesium, PGMs, and REEs (Figure 40 and Table 23).

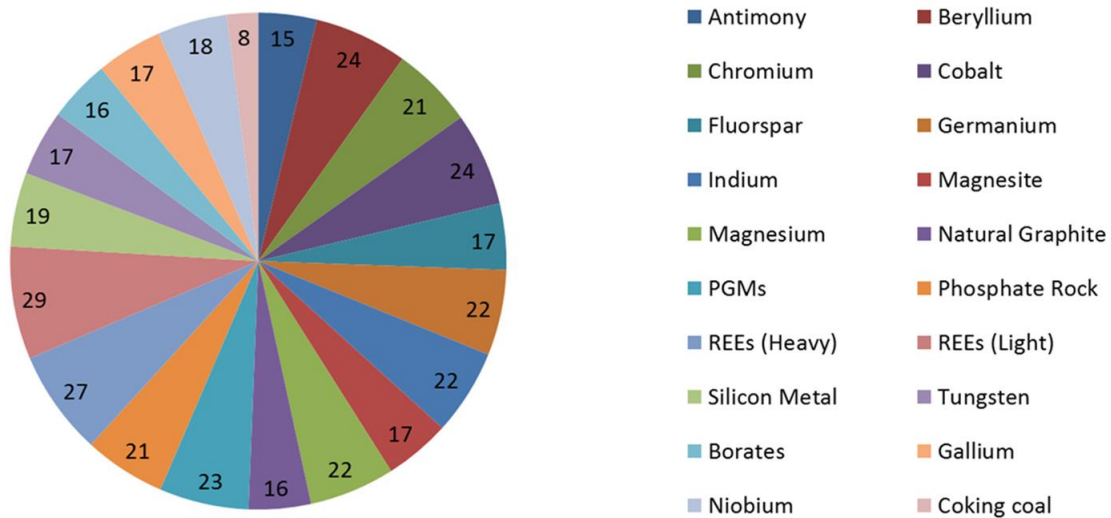

Figure 40 Survey responses to question 5.

Table 23 Survey responses to question 5.

Materials	Number of quotes
REEs (Light)	29
REEs (Heavy)	27
Beryllium	24
Cobalt	24
PGMs	23
Magnesium	22
Indium	22
Germanium	22
Chromium	21
Phosphate rock	21
Silicon metals	19
Niobium	18
Tungsten	17
Gallium	17
Fluorspar	17
Magnesite	17
Natural graphite	16
Borates	16
Antimony	15
Coking coal	8

Question 6: Does your organisation use the EU list of critical raw materials for decision making process and/or strategic planning activities regarding the supply of critical raw materials?

Most of the surveyed organisations (26) - responded positively to this question. From them, 8 organisations are governmental/ public bodies, 8 - research organisations/Universities, 6 - business/industry related and 4 - non-profit organisations. 19 organisations responded negatively to this question and 11 organisations did not provide feedback (Figure 41).

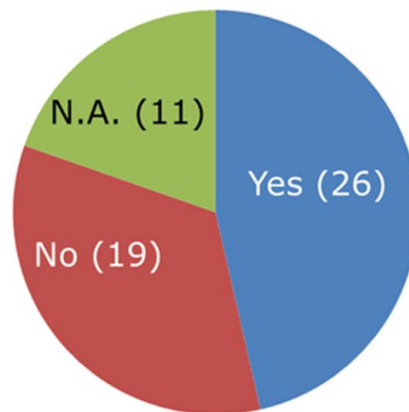

Figure 41 Survey responses to question 6.

Further, more details are provided regarding how the EU list is used for decision making/ strategic planning activities by different organisations or, respectively, why the EU list is not used for these purposes.

Question 6.1: How the EU list is used for decision making / strategic planning activities

- Monitoring policy and legislation related to CRMs: the list is used for advocacy purposes towards policy-makers and other stakeholders involved in policies;
- Regulatory affairs management: deciding and aligning strategy on how to respond to developments and who to engage with at EU level;
- Circular economy analysis and assessment of global megatrends and environmental impacts;
- Advise national companies and governments in the field of critical raw materials; used also as a reference point when dealing with industry requests;
- Supports/affects research strategies and development of research projects/activities (e.g. evaluation of ancient mining pile wastes; re-evaluation of REEs content in economic ore deposits for other metals etc.); AVALORE and INTRAW are examples of H2020 research projects launched using the EU list as a basis;
- Setting up proposals to national governments and Geological Surveys within the framework of the European Innovation Partnership (EIP) on raw materials;
- Highlighting the importance of primary raw materials production and exploration of new resources; it considers metals of interest for future exploration.

Question 6.2: Why the list is not used for decision making process and/or strategic planning activities

5 organisations declared that the list is not suitable for the purpose.

12 organisations pointed out other reasons, among which:

- No direct involvement in decision making process: organisations not being involved in a decision making process - requests from suppliers/customers are necessary stimulus for that to happen;
- No direct involvement in strategic activities: organisation not implementing decisions or strategic planning activities with regard to raw materials or are not directly involved in supply of raw materials;
- Questioning raw materials' definition: some organisations are not using or questioning the validity of the CRMs list by challenging the definition of some RMs ;
- Strong market orientated strategies: some stakeholders are using the list only as a reference; their business activities are determined mostly on revenues, metal price, as well as expected market developments;
- Precautions to use the list due to different technological and environmental/geopolitical developments;
- Not fully reflecting the situation for some materials; e.g. supply should be determined also by other factors;
- Lack of real expert analysis and predictions.

Question 7: If your organisation has developed its own list of critical raw materials, has the European Commission (EC) methodology been used as a reference?

17 organisations – mainly governmental/public bodies and research organisations - used the EC methodology as a reference (Figure 42): 7 organisations applied directly the methodology and 9 organisations adopted the methodology in order to fit their needs (Figure 43).

Most of the surveyed organisations did not replay this question. 12 organisations did not use the EC methodology as a reference (Figure 42).

Among the organisations which did not use the EC methodology as a reference, 4 organisations declared development of their own methodology and only 1 organisation declared adoption of another methodology as a reference.

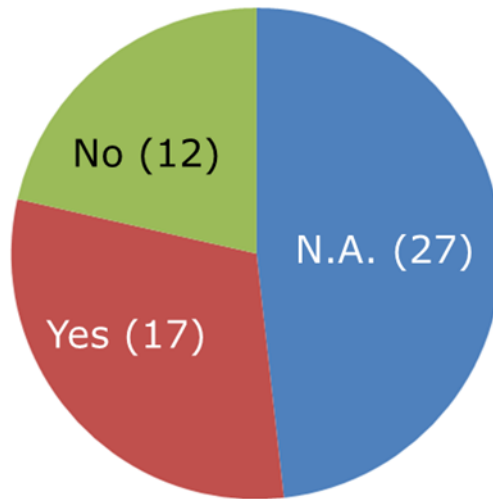

Figure 42 Survey responses to question 7 (A).

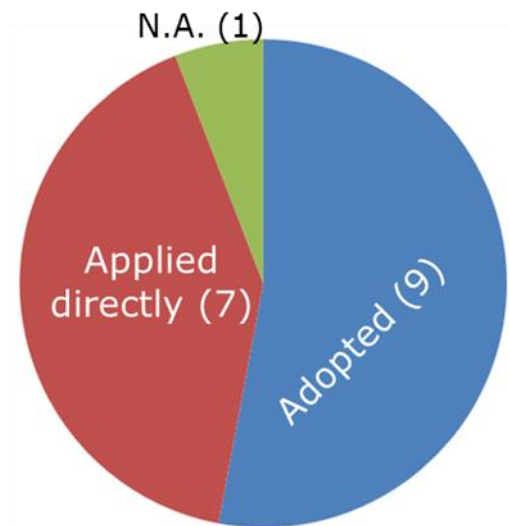

Figure 43 Survey responses to question 7 (B).

Additional information on how the EC methodology was adapted is provided below.

Question 7.1: How the EC methodology was modified to meet the needs of different organisations

- Modification of the 'Economic Importance' component; e.g. the EI is considered not only in respect to the VA of a certain sector but also the productivity of this sector is taken into account to scale the VA. Therefore, sectors with lower productivity are considered less important. The 'Supply Risk' is applied directly despite some concerns; e.g. relevance of the WGI to the conditions of the mining industry and trade of raw materials; transparency and clearance on the substitution indexes calculation and substitution effect of the supply risk; too

short timeframe considered for the recyclability parameter; supply chain approach not addressed.

- Supply chain analysis adopted – identified as a weak point of the EC methodology with too much emphasis on the mining stage solely. The refinery stage and trade products should be assessed as well, which would lead to more complexity. This approach has been implemented by several respondents.
- Use EC chart is used as a background analysis, particularly for specific commodities;
- Partial use of some of the indicators and data sources that the EC methodology has utilised (i.e., substitution) while developing an own Risk List.

Question 8: Is your own list of critical raw materials consistent with the EU list (2014 edition)?

5 organisations stated that their list of CRM is fully included into the EU CRM list. Only one organisation declared that its list is not included at all in the EU list (Figure 44).

Further more information is given on the materials assessed as critical for the surveyed organisations.

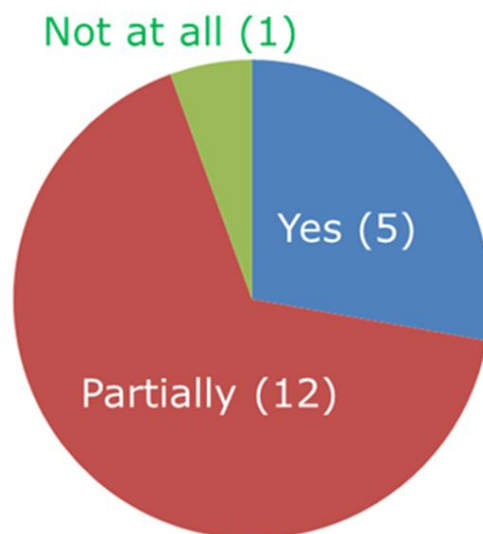

Figure 44 Survey responses to question 8.

Question 8.1: CRM selected as critical also for the surveyed organisations

The most quoted CRM were Fluorspar, Germanium, Indium and REEs (Figure 45 and Table 24).

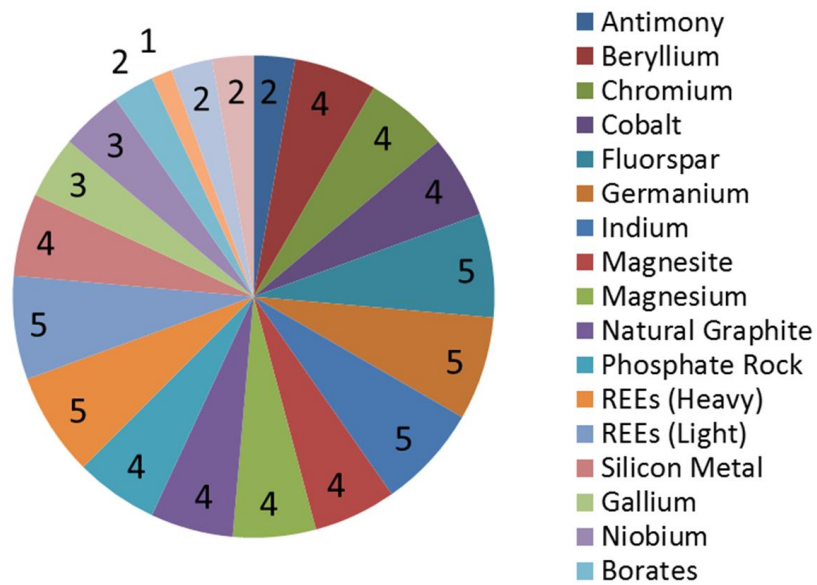

Figure 45 Survey responses to question 8.1.

Table 24 Survey responses to question 8.1.

Material	Number of quotes
REEs (Heavy)	5
REEs (Light)	5
Fluorspar	5
Germanium	5
Indium	5
Beryllium	4
Cobalt	4
Magnesium	4
Chromium	4
Magnesite	4
Natural graphite	4
Silicon metal	4
Phosphate rock	4
Gallium	3
Niobium	3
Antimony	2
Tungsten	2
PGMs	2
Borates	2
Coking coal	1

Question 9: Are there any other materials that you consider as critical for your organisation? If yes, please specify which are these materials and why are they important for your organisation?

The following materials were stated as materials of interest to stakeholders participating to the survey (Table 25).

Table 25 Survey responses to question 9.

Material	Reasons
Natural rubber	Supply, volatility, concentrated in a handful number of countries in south east Asia operating a cartel; the material is critical for the modern mobility means (tyres mainly).
Tin	Might become critical when the EC methodology is used not only for several points in time but also for time series.
Vanadium	Might become critical when the EC methodology is used not only for several points in time but also for time series.
Complex low grade materials if containing Cu,Sn, Pb and Ni	Business model based upon these materials.
Molybdenum	Might become critical when the EC methodology is used not only for several points in time but also for time series.
Tantalum	Might become critical when the EC methodology is used not only for several points in time but also for time series; Ta has a high socio-economic importance and cannot be easily substituted.
Materials with high environmental impact: heavy metals	The recycling potential for mercury for instance appears underused.
Phosphorus	The environmental co-benefits.
All metals	EU policy should not focus solely on CRM. So far the list has led to some innovation focus and some support to substitution. Substitution is a normal business practice but its value should be assessed on a Life-cycle basis and considering impacts and benefits (fit for purpose).
Prospective materials whose supply can become in danger (e.g. Iron)	Iron is an example of a non-critical material that, in case of war in the Eastern border of Europe and in seas will become critical.
Silicon metal should be replaced by high-purity quartz	Raw material for silicon metal is essentially produced from deposits of high-purity quartz.
Coking coal should be replaced by low-sulfur bituminous coal	Raw material for coking coal is essentially produced by destructive distillation of low-ash, low-sulphur bituminous coal.
Nickel, Copper, Zinc, Bauxite, Perlite	Economically and industrially important commodities for different countries.
Gold	Economically and industrially important commodity for different countries; high market value and a great economic relevance, but difficulty for extraction from refractory materials and wastes of treatment, especially if contained in trace amounts - not economic and

Material	Reasons
	incompatible with the environment processes. Consequently these important resources are not valorised.
Rhenium	Unique metal - considered in industrial quantities in different areas (used as a catalyst in the production of high octane gasoline).
Silver	High market value and a great economic relevance, but difficulty for extraction from refractory materials and wastes of treatment, especially if contained in trace amounts - not economic and incompatible with the environment processes. Consequently these important resources are not valorised.
Raw materials for the steel industry	Iron ore, metallurgical coal (includes coking coal and PCI coal), metallurgical coke, scrap, ferrosilicon, zinc, nickel, molybdenum, chromium, tungsten, cobalt, vanadium, niobium, manganese in form of metals or ferroalloys and natural gas or liquid natural gas (LNG) alternatively.
Raw materials for refractory industry	Magnesite, Graphite, Zirconia based raw materials, Alumina (calcined, Tabular) materials, Chrome Ore, Dolomite, Andalusite, Chamotte and Fire Clay, Kyanite, Olivine, Silicon Carbide, Refractory Bauxite.
Raw materials for the non-ferrous metals industry	Aluminium, Copper, Tungsten, Molybdenum, Rare Earth, and others.

7.4 General observations from the survey

The survey received broad audience (56 respondents in total) which clearly shows the engagement and interest of various organisations towards the raw materials policy in EU.

In general, it indicates positive approach of the surveyed organisations in relation to the EU Raw Materials policies. Most of the respondents (around 40%) are business/industry related organisations; followed by Government/public bodies and research institute/university – both representing 16% of the respondents.

Only few of the surveyed organisations were not aware about the regular publication of the EU CRM list. Few organisations (6 out of 56) declared that the EU list is not relevant to their needs. From the rest, 26 organisations have declared partial coverage of their needs. Various reasons were stated for that: from materials not included in the current list or other materials that should not be included, to inconsistency of the methodology or the quality of the data used for the calculations. Lack of real expert analysis and interpretation was also stressed.

The EU CRM list is used in a large part for strategic planning and decision-making processes at both corporate and governmental level (around 30% of the respondents). The list is also broadly used for general information purposes (20%). Defining R&D focus/strategies and education programmes is also an important part of the CRM list usage (18%). It is important to notice the use of the CRM list in R&D proposals' preparation within the EIP.

Only 2 organisations used the list for improvement of their own methodology. 17 organisations declared use of EC methodology as reference for their own criticality

assessments: 7 organisations applied directly the methodology and 9 organisations adopted the methodology in order to best fit their needs. 4 organisations have developed their own methodology and 1 organisation adopted another methodology (different than the EC).

Despite the general positive approach, several organisations have pointed various scarcities and shortcomings of the EC methodology and EU CRM list, among which:

- Shortfalls in term of definition of criticality and definition of raw materials;
- Unappropriated calculation of the Economic Importance and the Supply Risk component;
- Need for supply chain approach;
- Lacking exact statistical data on global, EU and national scale;
- Need of wider scope – more materials to be screened;
- Need of dynamic approach – different scenarios of general shortage of supply to be taken into consideration;
- The substitution should be considered more carefully;

The above can be taken as options for **future improvement** of the methodology.

7.5 Literature review: assessment of national and other criticality assessments

In addition to the survey, an extensive literature review was performed to reveal different approaches followed in relation to criticality assessments of raw materials and policies to deal with shortages in the raw materials supply. Over 200 sources and organisations worldwide dealing with criticality assessments were identified. Further division of the sources is performed based on whether they are related to methodologies for assessing criticality and/or CRMs lists. Specific reference to the EC methodology and CRMs list is also done.

The results of the literature review are summarised in several tables in **Annex 3** and is structured as follows:

- Overview of organisations involved in assessment of materials criticality;
- Organisations developing their own methodologies;
- Scientific publications describing criticality methodologies;
- Organisations developing their own CRMs list;
- Scientific publications providing information on the materials being screened;
- References to the screened sources

In total, 212 communications dealing with critical raw materials were screened, including 54 scientific publications describing different criticality methodologies and 55 publications providing specific information of the materials being investigated.

Around 233 organisations were identified by the literature review as being involved in criticality studies. Among them, 72 organisations developed their own methodology and 58 organisations developed their own CRMs list. An interesting observation showing the active role of EU in the field of raw materials is the high number of EU organisations involved in raw materials criticality studies: 176 EU organisations against only 57 organisations outside the EU.

Within EU, 8 organisations have developed both a methodology and a list, 14 developed a methodology; 30 organisations developed their own list using the existing methodology (Figure 46).

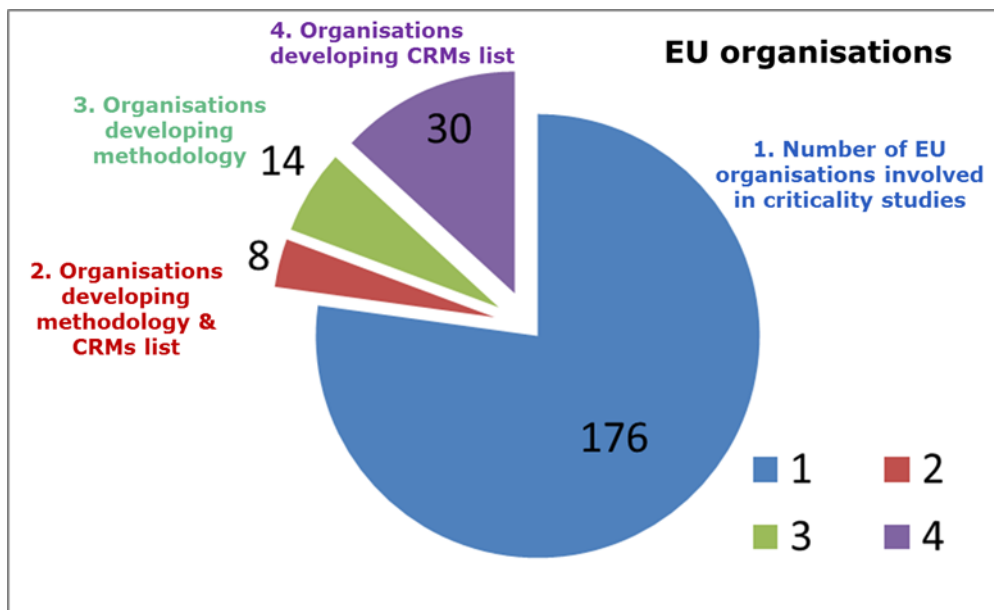

Figure 46 EU organisations involved in criticality studies, developing own methodology and/or CRMs list.

Outside the EU, 18 organisations developed both a methodology and a list, 10 developed a methodology and 2 organisations issued their own CRMs list using existing methodologies (Figure 47).

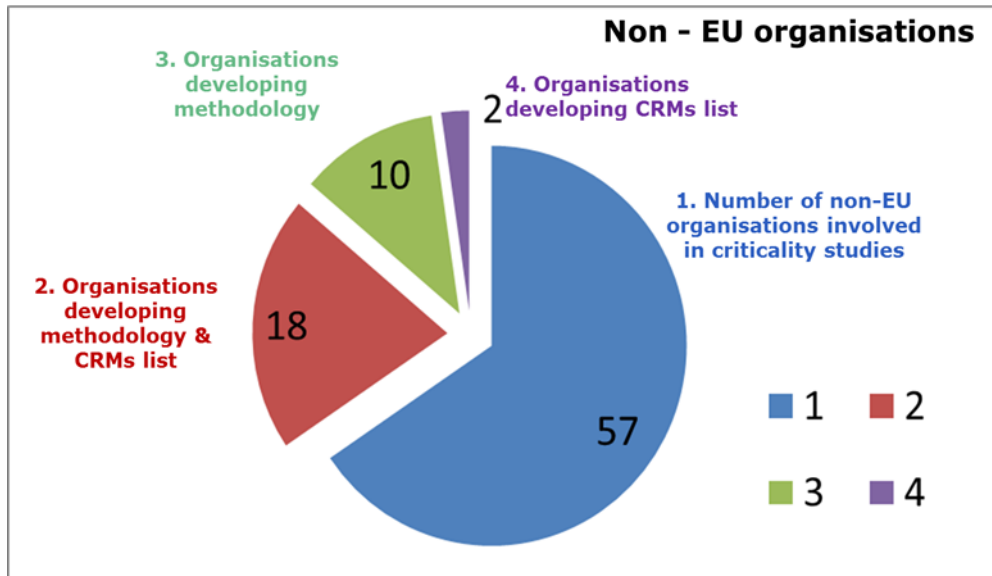

Figure 47 Non-EU organisations involved in criticality studies, developing own methodology and/or CRMs list.

This clearly shows the positive fact that the EC organisations prefer to use the existing methodologies - mostly the EC methodology - for their purposes rather than developing own methodology. The opposite tendency is observed for non-EU organisations: almost half (28 out of 57) of the organisations involved in criticality studies are developing their own methodology and/or CRMs list.

An example how the EC methodology/CRMs list are used is given in Table 26 below. Further to these 16 organisations/projects, 182 more organisations make reference to the 2014 EC report, in some cases using the data from the study.

Table 26 Organisations using the EC methodology / EC CRMs list

Organisations	Relation to the EC methodology and/or CRM list	Objective of the organisation
Alpen-Adria University (AT)	References the EC methodology and uses the EC list	To monitor potential disruption in supply of critical materials which could endanger a transition to low-carbon infrastructure
Bureau de Recherches Géologiques et Minières (BRGM, FR)	References the EC methodology and uses the EC list	To assess materials critical to France through the development and use of a criticality methodology
Centro Ricerche Fiat (CRF, IT)	Uses the EC list	To identify critical Raw Materials of relevance to the automotive sector
Environment Agency (EA, UK)	References the EC methodology and uses the EC list	To turn waste into resources thereby supporting UK economy
EU FP7 DESIRE project (EU)	References the EC methodology and uses the EC list	To develop a system of indicators for a resource efficient Europe
Fraunhofer-Institut für System- und Innovationsforschung (ISI, DE)	Uses the EC methodology and EC list	To assess raw materials for emerging technologies by the development of a criticality methodology and its use in the definition of a list of critical materials
Geoscience Australia (AU)	Uses the EC list	To examine critical commodities from an Australian perspective and presents

Organisations	Relation to the EC methodology and/or CRM list	Objective of the organisation
		comprehensive technical (geological) information on Australia's resources and resource potential for these
Imperial College London (UK)	References the EC methodology and uses the EC list	To assess metals critical to the development of thin film photovoltaics
Inha University (KR)	Uses the EC list	To assess the materials consumption and requirement in wind energy system in the EU 27
Japan Oil, Gas and Metals National Corporation (JOGMEC, JP)	Uses the EC methodology	To assess the degree of importance of mineral commodities in Japan in order to contribute to secure stability of mineral resources, based on the EC methodology
Ministry for Resources and Energy (AU)	Uses the EC list	To examine critical commodities from an Australian perspective and presents comprehensive technical (geological) information on Australia's resources and resource potential for these
Ministry of Economic Affairs (NL)	Uses the EC methodology and EC list	To assess the vulnerability of the Dutch economy and provide guidance to stakeholders regarding raw materials through the development of a qualitative and quantitative criticality method and its use
Ministry of Foreign Affairs (NL)	References the EC methodology and uses the EC list	To assess security of raw material supplies as economic and security concern for the Netherlands
Netherlands Organisation for Applied Scientific Research (TNO, NL)	Uses the EC methodology and EC list	To assess the vulnerability of the Dutch economy and provide guidance to stakeholders regarding raw materials through the development of a qualitative and quantitative criticality method and its use
Oakdene Hollins (UK)	Uses the EC methodology and EC list	To define a list of critical materials for the EU through the use of the EC methodology
Polytechnic University of Tomsk (R)	Uses the EC list	To assess the materials consumption and requirement in wind energy system in the EU 27

Finally, among the 25 organisations which do not use nor make reference to the EC methodology or CRMs list, 6 published their contributions before 2010, therefore lacking the opportunity to use and/or make reference to the EC report.

7.6 Conclusions

A) On the literature review:

Criticality of raw materials is a hot topic for many organisations worldwide as around 233 organisations involved in criticality assessment of raw materials were identified from the conducted literature review. Most of the organisations however, rely on existing methodologies and CRMs lists – only 72 organisations worldwide developed their own methodology and 58 developed their own CRMs list (Figure 48). Sources in Chinese, Korean or Japanese not translated in English could not be screened due to the language barrier.

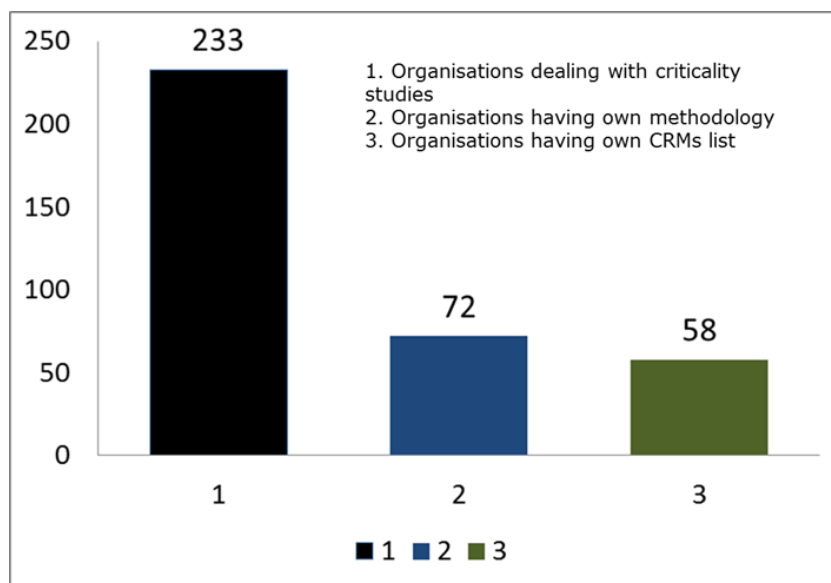

Figure 48 Number of organisations dealing with criticality studies, developing own methodology and CRMs list.

The main objectives of the identified organisations developing own methodology and/or CRMs list can be classified as follows:

- **Assess vulnerability in terms of access to raw materials** of countries' economy/ sectors/ companies. The studies identify materials of economic interest that might become critical and monitor potential constraints and supply disruption of these materials.
- **Policy support** at country level and more globally EU/US level. Reliable prediction of supply disruptions is an important element for different policy makers: e.g. policies supporting transition to low carbon technologies, resource efficiency, recycling, reuse, substitution, waste management, domestic extraction and production, environmental concerns etc.
- **Raise awareness** of businesses and governments and serve as reference for those who supply and those who utilise resources.
- **Forecast:** estimating future supply, demand and growth outlook is another objective of the screened studies. Assessing the impact of future metals demand on different energy scenarios for example may have direct policy implications.

Many of the screened studies have dual or even triple purpose, e.g. aiming to assess vulnerability of companies, sectors (e.g. energy), national economies in general etc.;

raise awareness and some of them guidelines and policy support at country level. A disaggregation of the number of studies having the above objectives can be seen in Figure 49 and Figure 50.

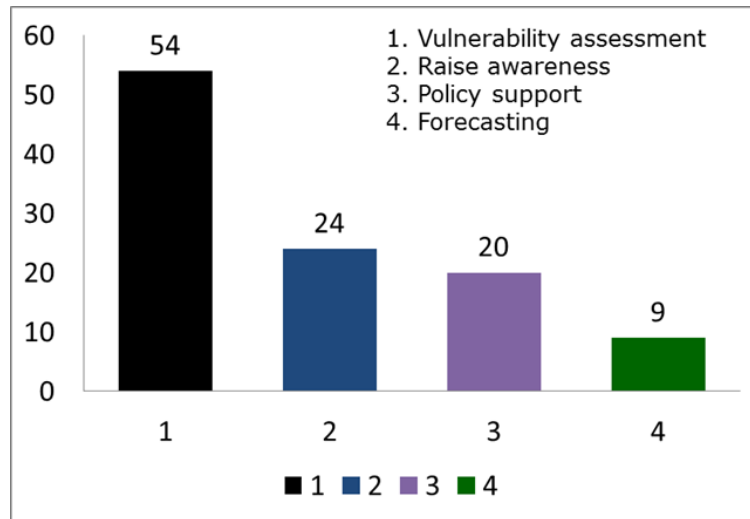

Figure 49 Number of organisations developing own methodology having as an objective: vulnerability assessments and/or raise awareness and/or policy support and/or forecasting

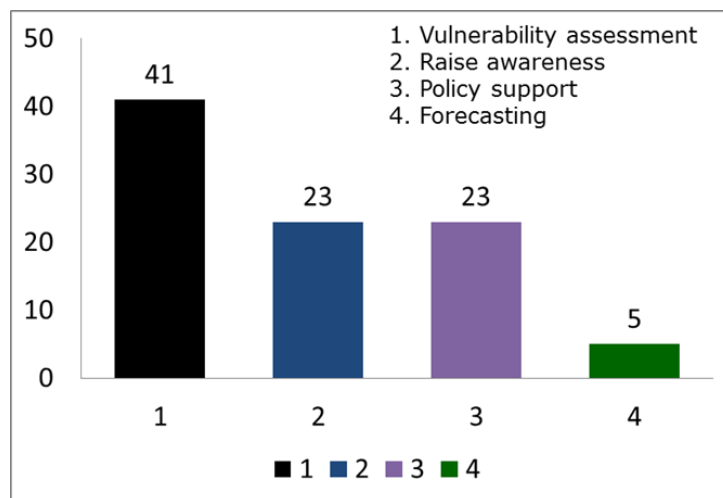

Figure 50 Number of organisations developing own CRMs list having as an objective: vulnerability assessments and/or raise awareness and/or policy support and/or forecasting

What can be clearly noted is that criticality studies are usually done with the purpose to assess vulnerability of a stakeholder/sector/national economy towards raw materials supply. Significant number of studies are dedicated also to raise awareness and to support policy decisions. In particular, organisation developing own lists are more active in policy support activities while the organisations developing own criticality methodology are rather interested in vulnerability assessments. Only few studies are dedicated to forecasting purposes.

The EC methodology and CRMs list have a high visibility worldwide – referenced in over 180 literature sources. The literature review showed the active and predominant role of Europe in general in this topic. This can be partially explained by the fact that solely sources in English (or translated in English) could be screened. However, one shall also underline that EU Member States and many EU stakeholders are very aware of the challenges related to supply of raw materials from outside the EU. As Member States have far reaching competences in terms of raw materials policy and strategies, they do adopt or modify the EC methodology in a way to correspond to their own needs.

However, it should be noted that only in several cases the EC methodology was applied directly. Though the EC methodology / CRMs list are referenced in over 180 sources, only 16 organisations report using them directly.

B) On the survey:

The majority of the EU stakeholders are aware of the existence of the EC methodology and refer to it while adapting it if needed. The reasons for that are summarised above. Therefore, it is recognised that the EU list is a strong tool. It provides a pan-European picture albeit not necessary reflecting the picture within the Member States.

At EU level, as shown clearly by the survey, there is a high awareness in relation to the EC methodology and the CRMs list. The list is used predominantly by business and industry-related organisations. In addition, it facilitates and supports the Member States industry in their decision-making process and future oriented business strategies on raw materials. Moreover, the EU CRM list has an impact on prioritising and setting up R&D projects – both within H2020 and the launch of EIP Commitments as well as applying for national funding programmes. A related supplementary use of the list is the tailoring of Master and PhD education programmes in the field of raw materials.

The EU CRM list is consulted and used by many different organisations and stakeholders for reasons ranging from obtaining general information to making future business strategy and R&D/education purposes. Nevertheless, often the document is perceived as too general to fit the needs of different stakeholders or countries and therefore it needs to be adopted / modified.

Based on the feedback from the survey, the following points were taken into consideration for the 2016 methodology revision:

- Wider scope of the list – more materials will be screened;
- Advancing on the definitions used in the methodology;
- Improving and refining both the EI and SR components for more reliable and transparent calculations;
- Where possible, supply chain approach will be considered;
- Experts will be involved where possible and required for instance through expert workshops;
- Improving the data quality: using recent and good quality data as well as time series for more robustness.

8 REFERENCES

- Achzet, B. and C. Helbig. 2013. How to evaluate raw material supply risks—an overview. *Resources Policy* 38(4): 435–447.
- Achzet, B., A. Reller, V. Zepf, C. Rennie, M. Ashfield, and J. Simmons. 2011. *Materials critical to the energy industry: An introduction*. University of Augsburg. https://www.physik.uni-augsburg.de/lehrstuehle/rst/downloads/Materials_Handbook_Rev_2012.pdf. Accessed February 25, 2016.
- AdC. 2012. *Analise do sector e da fileira da cortica em Portugal*. Lisbon, Portugal: National Competition Authority.
- AEA Technology. 2010. *Review of the Future Resource Risks Faced by Business and an Assessment of Future Viability*. Final Report to the Department for Environment, Food and Rural Affairs. London.
- Anon. 2015. Information on EU Forest Fires. *DG Joint Research Centre*. <http://forest.jrc.ec.europa.eu/effis/>. Accessed March 4, 2016.
- APCOR. 2011. *Estudo De Caracterização Sectorial 2011*. Associação Portuguesa da Cortiça – Cork Information Bureau. <http://www.apcor.pt/>. Accessed March 2, 2016.
- APCOR. 2014. *Cork Sector in Numbers*. Associação Portuguesa da Cortiça – Cork Information Bureau. <http://www.apcor.pt/>. Accessed March 2, 2016.
- APCOR. 2015a. *APCOR's Cork Yearbook 2015*. Associação Portuguesa de Cortiça.
- APCOR. 2015b. Webpage on cork stoppers. <http://www.apcor.pt/en/products/cork-stoppers/>. Accessed March 2, 2016.
- Bäckström, M. 2012. *Compendium of mining and processing waste management technologies*. MIN-NOVATION Mining and Mineral Processing Waste Management Innovation Network. Sweden: Örebro university. <http://www.minnovation.eu/uploads/Compendium%20of%20Mining%20and%20Processing%20Waste%20Management%20Technologies.pdf>. Accessed February 22, 2016.
- Baranzelli, C., C. Jacobs, F. Batista E Silva, C. Perpiña Castillo, A. Lopes Barbosa, J. Arevalo Torres, and C. Lavallo. 2014. *The Reference Scenario in the LUISA platform – Updated configuration 2014 Towards a Common Baseline Scenario for EC Impact Assessment procedures*. EUR - Scientific and Technical Research Reports. Luxembourg: Publications Office of the European Union. <http://publications.jrc.ec.europa.eu/repository/handle/JRC94069>. Accessed February 22, 2016.
- BGS. 2012. *Risk list 2012: An updated supply risk index for chemical elements or element groups which are of economic value*. Nottingham, United Kingdom: British Geological Survey.
- BGS. 2014. *European Mineral Statistics 2008-2012*. Keyworth, Nottingham: British Geological Service. <https://www.bgs.ac.uk/downloads/start.cfm?id=1389>. Accessed March 2, 2016.
- Binnemans, K., P.T. Jones, B. Blanpain, T. Van Gerven, Y. Yang, A. Walton, and M. Buchert. 2013. Recycling of rare earths: a critical review. *Journal of Cleaner Production* 51: 1–22.
- BIO by Deloitte. 2015. *Study on Data for a Raw Material System Analysis: Roadmap and Test of the Fully Operational MSA for Raw Materials*. Prepared for the European Commission, DG GROW.

- CEFIC. 2014. *CEFIC study Measuring Bio-based raw materials use in the chemical industry / Bioeconomy Observatory*. European Chemical Industry Council. <https://biobs.jrc.ec.europa.eu/stakeholder/cefic-study-measuring-bio-based-raw-materials-use-chemical-industry>. Accessed March 1, 2016.
- CEPI. 2015. *Key Statistics 2014. European Pulp and Paper Industry*. Confederation of European Paper Industries (CEPI). <http://www.cepi.org/system/files/public/documents/publications/statistics/2015/Key%20Statistics%202014%20FINAL.pdf>. Accessed February 22, 2016.
- Chapman, A., J. Arendorf, T. Castella, L. Tercero Espinoza, S. Klug, and E. Wichmann. 2013. *Study on Critical Raw Materials at EU Level: Final Report*. Oakdene Hollins, Fraunhofer ISI.
- Ciacchi, L., B.K. Reck, N.T. Nassar, and T.E. Graedel. 2015. Lost by Design. *Environmental Science & Technology* 49(16): 9443–9451.
- Coad, L., A. Campbell, L. Miles, and K. Humphries. 2008. *The Costs and Benefits of Forest Protected Areas for Local Livelihoods: a review of the current literature*. Working Paper. Cambridge, UK: UNEP World Conservation Monitoring Centre.
- De Sousa, E., M. Santos, M. Varela, and J. Henriques. *Perda de vigor dos montados de sobre e azinho: análise da situação e perspectivas*. Portuguese Ministry of Agriculture, Rural Development and Fishery, Portuguese Directorate-General of Forest Resources, National Institute of Biological Resources.
- Deguignet, M., D. Juffe-Bignoli, J. Harrison, B. MacSharry, N. Burgess, and N. Kingston. 2014. United Nations list of protected areas. *UNEP-WCMC: Cambridge, UK*.
- DG ENV. 2015. DG Environment webpage on Forest Fires. <http://ec.europa.eu/environment/forests/fires.htm>. Accessed April 14, 2016.
- DHI. 2012. *Establishment of guidelines for the inspection of mining waste facilities, inventory and rehabilitation of abandoned facilities and review of the BREF document. Annex 3: Supporting document on closure methodologies for closed and abandoned mining waste facilities*. Brussels: European Commission DG Environment. http://ec.europa.eu/environment/waste/mining/pdf/Inspection-Rehabilitation_BREF_report.pdf. Accessed February 22, 2016.
- Duclos, S.J.O., Jeffrey P. Konitzer, Douglas G. 2010. Design in an Era of Constrained Resources. *Mechanical Engineering* 132(9): 36–40.
- Dutch Ministry of Agriculture. 2009. *Biodiversity works for nature for people forever, The Biodiversity Policy Programme of the Netherlands 2008-2011*. The Hague: Dutch Ministry of Agriculture, Nature and Food Quality.
- Dutch Ministry of Foreign Affairs. 2013. *Netherlands: Policy Document on Raw Materials - European Commission*. Policy Paper. The Hague: Dutch Ministry of Foreign Affairs. <https://ec.europa.eu/growth/tools-databases/eip-raw-materials/en/community/document/netherlands-policy-document-raw-materials>. Accessed March 1, 2016.
- Eagles, P., S. McCool, and C. Haynes. 2002. *Sustainable Tourism in Protected Areas Guidelines for Planning and Management*. UN Environment Programme, World Tourism Organization, IUCN - The World Conservation Union. <http://www.unep.fr/shared/publications/other/3084/best-practice-8.pdf>. Accessed March 4, 2016.
- EC. 2009. *Directive 2009/28/EC Of The European Parliament And Of The Council Of 23 April 2009 on the promotion of the use of energy from renewable sources and amending and subsequently repealing Directives 2001/77/EC and 2003/30/EC*. Brussels: European Commission (EC). <http://eur-lex.europa.eu/legal-content/EN/TXT/?uri=CELEX%3A32009L0028>. Accessed March 4, 2016.

- EC. 2010. *Critical raw materials for the EU*. Report of the Ad-hoc Working Group on defining critical raw materials. Brussels, Belgium: European Commission (EC). http://ec.europa.eu/enterprise/policies/rawmaterials/documents/index_en.htm. Accessed December 27, 2012.
- EC. 2012. *Innovating for Sustainable Growth: A Bioeconomy for Europe*. {SWD(2012) 11 final}. Brussels: European Commission (EC). http://ec.europa.eu/research/bioeconomy/pdf/201202_innovating_sustainable_growth_en.pdf. Accessed March 1, 2016.
- EC. 2013. *Forest resources in the EU*. Memo/13/806. Brussels: European Commission (EC). http://europa.eu/rapid/press-release_MEMO-13-806_en.htm. Accessed March 4, 2016.
- EC. 2014. *Report on Critical Raw Materials for the EU*. Report of the Ad-hoc Working Group on defining critical raw materials. Brussels, Belgium: European Commission (EC). http://ec.europa.eu/enterprise/policies/raw-materials/files/docs/crm-report-on-critical-raw-materials_en.pdf. Accessed June 10, 2014.
- EC. 2015. Information on sustainable forest management: Voluntary schemes. *European Commission (EC)*. <https://ec.europa.eu/energy/en/topics/renewable-energy/biofuels/voluntary-schemes>. Accessed March 4, 2016.
- EEA. 2016. Natura 2000 Data - the European network of protected sites. <http://www.eea.europa.eu/data-and-maps/data/natura-7#tab-metadata>. Accessed April 20, 2016.
- Erdmann, L., S. Behrendt, and M. Feil. 2011. *Kritische Rohstoffe für Deutschland*. Berlin: Institut für Zukunftsstudien und Technologiebewertung (IZT), adelphi. <https://www.izt.de/fileadmin/publikationen/54416.pdf>. Accessed February 22, 2016.
- Erdmann, L. and T.E. Graedel. 2011. Criticality of Non-Fuel Minerals: A Review of Major Approaches and Analyses. *Environmental Science & Technology* 45(18): 7620–7630.
- ESA. 2010. Land cover 2010. *European Space Agency*. http://www.esa.int/spaceinimages/Images/2014/10/Land_cover_2010. Accessed March 4, 2016.
- ETRMA. 2011. End-of-Life Tyres Management in Europe. *European Tyre & Rubber Manufacturers' Association*. <http://www.etrma.org/tyres/ELTs/ELT-management>. Accessed March 1, 2016.
- ETRMA. 2012. *European Tyre & Rubber Industry Statistics*. European Tyre & Rubber Manufacturers' Association (ETRma). <http://www.etrma.org/statistics-2>. Accessed March 1, 2016.
- ETRMA. 2014. *European Tyre & Rubber Industry Statistics*. European Tyre & Rubber Manufacturers' Association (ETRma). <http://www.etrma.org/statistics-2>. Accessed March 1, 2016.
- EUROSTAT. 2015. Information on Natural Rubber Imports. <http://ec.europa.eu/eurostat>. Accessed March 2, 2016.
- FAO. 2010a. *Global Forest Resources Assessment 2010*. FAO Forestry Paper 163. Rome: Food and Agriculture Organization of the United Nations.
- FAO. 2010b. *Newsletter n°5: Special focus on adaptation of Cork Oak landscapes*. Food and Agriculture Organization (FAO) of the United Nations (UN). <http://www.fao.org/forestry/24049-0d0f7526e0dde2b210afee69f94c22931.pdf>. Accessed March 2, 2016.
- FAOSTAT. 2015. Rubber Statistics. Statistics Division of the Food and Agricultural Organization (FAO). <http://faostat3.fao.org/search/rubber/E>. Accessed March 1, 2016.

- Fizaine, F. 2013. Byproduct production of minor metals: Threat or opportunity for the development of clean technologies? The PV sector as an illustration. *Resources Policy* 38(3): 373–383.
- Fliess, B., C. Arriola, and P. Liapis. 2014. Recent developments in the use of export restrictions in raw materials trade. In *Export Restrictions in Raw Materials Trade: Facts, Fallacies and Better Practices*, ed. by OECD, 17–61. Organisation for Economic Co-operation and Development (OECD). <http://www.oecd.org/trade/benefitlib/export-restrictions-raw-materials-2014.pdf>. Accessed February 29, 2016.
- Fliess, B. and T. Mård. 2012. *Taking Stock of Measures Restricting the Export of Raw Materials*. OECD Trade Policy Papers. Paris: Organisation for Economic Co-operation and Development, October 5. <http://www.oecd-ilibrary.org/content/workingpaper/5k91gdmdjbt-en>. Accessed February 29, 2016.
- FSC. 2013. Forest Stewardship Council International. *Forest Stewardship Council International*. <http://info.fsc.org/certificate.php>. Accessed March 4, 2016.
- FSC. 2014. Forest Stewardship Council - Global FSC certificates: type and distribution.
- Gardiner, B., K. Blennow, J. Carnus, P. Fleischer, F. Ingemarson, G. Landmann, M. Lindner, et al. 2011. *Destructive Storms in European Forests: Past and Forthcoming Impacts*. European Forest Initiative - Report to the EU Commission, DG Environment. http://ec.europa.eu/environment/forests/pdf/STORMS%20Final_Report.pdf. Accessed March 4, 2016.
- GE. 2010. *Response to the U.S. Department of Energy's Request for Information*. General Electric.
- Graedel, T.E., J. Allwood, J.-P. Birat, M. Buchert, C. Hagelüken, B.K. Reck, S.F. Sibley, and G. Sonnemann. 2011. What Do We Know About Metal Recycling Rates? *Journal of Industrial Ecology* 15(3): 355–366.
- Graedel, T.E., R. Barr, C. Chandler, T. Chase, J. Choi, L. Christoffersen, E. Friedlander, et al. 2012. Methodology of Metal Criticality Determination. *Environmental Science & Technology* 46(2): 1063–1070.
- Graedel, T.E., E.M. Harper, N.T. Nassar, P. Nuss, and B.K. Reck. 2015. Criticality of metals and metalloids. *Proceedings of the National Academy of Sciences* 112(14): 4257–4262.
- Hagelüken, C. and C.E. Meskers. 2010. Complex life cycles of precious and special metals. In *Linkages of Sustainability*, ed. by TE Graedel and E van der Voet, 4:. Cambridge, MA: MIT Press.
- ICNF. 2013. *IFN6 – Áreas dos usos do solo e das espécies florestais de Portugal continental. Resultados preliminares*. Lisbon, Portugal: National Institute for Forest and Nature Conservation.
- IDH. 2015. The Sustainable Trade Initiative. <http://www.idhsustainabletrade.com/>. Accessed March 1, 2016.
- IMA. 2013. *Recycling Industrial Minerals*. Brussels: Industrial Minerals Association (IMA). http://www.ima-europe.eu/sites/ima-europe.eu/files/publications/IMA%20Recycling%20Sheets%20FULL%20published%20on%2024.10.2013_0.pdf. Accessed February 22, 2016.
- IPCC. 2014. *Climate Change 2014 Synthesis Report*. https://www.ipcc.ch/pdf/assessment-report/ar5/syr/AR5_SYR_FINAL_SPM.pdf. Accessed March 4, 2016.
- IRSG. 2015. International Rubber Study Group - Statistics. Subscription required. <http://www.rubberstudy.com/statistics.aspx>. Accessed March 1, 2016.

- ISC. 2015. Invasive Species Compendium – information on *Microcyclus ulei* (South American leaf blight of rubber). <http://www.cabi.org/isc/datasheet/33893>. Accessed March 4, 2016.
- IUCN. 2015. International Union for Conservation of Nature – information on what are protected areas. https://www.iucn.org/about/work/programmes/gpap_home/pas_gpap/. Accessed March 4, 2016.
- IVA. 2015. *Evolução da Produção de Vinho: Série 2000/2001 a 2014/2015*. Ministerio da Agricultura, Instituto da Vinha e do Vinho. <http://www.ivv.min-agricultura.pt/np4/estatistica>. Accessed April 20, 2016.
- IW Consult. 2011. *Rohstoffsituation Bayern - keine Zukunft ohne Rohstoffe: Strategien und Handlungsoptionen (Raw materials situation in Bavaria - no future without raw materials: strategies and opportunities of action)*. IW Consult GmbH Köln. http://www.rohstoffstrategie-bayern.de/fileadmin/user_upload/rohstoffstrategie/dokumente/vbw_Studie_Rohstoffe_Bayern_web.pdf. Accessed September 17, 2013.
- Jackson, T. and K. Green. 2015. *Fraser Institute Annual Survey of Mining Companies: 2014*. Fraser Institute. <https://www.fraserinstitute.org/studies/annual-survey-of-mining-companies-2014>. Accessed February 29, 2016.
- JRC. 2013. *Forest Fires in Europe, Middle East and North Africa 2013*. DG Joint Research Centre.
- JRC. 2015. Forest and Climate Change. *Joint Research Center*. <http://forest.jrc.ec.europa.eu/activities/climate-change/>. Accessed March 4, 2016.
- Klerath, T. and C. Wang. 2013. *The Global Wine Industry*. Morgan Stanley Research Asia/Pacific. <http://blogs.reuters.com/counterparties/files/2013/10/Global-Wine-Shortage.pdf>. Accessed April 20, 2016.
- Labbé, J. and G. Daw. 2012. *Panorama 2010 du marché du Lithium*. French Geological Survey (BRGM). <http://infoterre.brgm.fr/rapports/RP-61340-FR.pdf>. Accessed March 2, 2016.
- Laborde, D. 2011. Assessing the land use change consequences of European biofuel policies. *International Food Policy Institute (IFPRI)*.
- Laborde, D., M. Padella, R. Edwards, and L. Marelli. 2014. *Progress in estimates of ILUC with MIRAGE model*. EUR - Scientific and Technical Research Reports. Publications Office of the European Union. JRC83815. <http://publications.jrc.ec.europa.eu/repository/handle/111111111/34507>. Accessed March 4, 2016.
- LADA. 2010. LADA Land Use system maps. *Land Degradation Assessment of Drylands*. http://www.fao.org/nr/lada/index.php?option=com_content&view=article&id=154&Itemid=184&lang=en. Accessed March 4, 2016.
- Lavalle, C., C. Baranzelli, F.B. e Silva, S. Mubareka, C.R. Gomes, E. Koomen, and M. Hilferink. 2011. A High Resolution Land Use/Cover Modelling Framework for Europe: Introducing the EU-ClueScanner100 Model. In *Computational Science and Its Applications - ICCSA 2011*, ed. by Beniamino Murgante, Osvaldo Gervasi, Andrés Iglesias, David Taniar, and Bernady O. Apduhan, 60–75. Lecture Notes in Computer Science 6782. Springer Berlin Heidelberg, June 20. http://link.springer.com/chapter/10.1007/978-3-642-21928-3_5. Accessed March 4, 2016.
- MADRF. 2003. *Order No. 4044/2003 of February 27*. Portuguese Ministry of Agriculture, Rural Development and Fishery.

- Maes, J., A. Barbosa, C. Baranzelli, G. Zulian, F.B. e Silva, I. Vandecasteele, R. Hiederer, et al. 2014. More green infrastructure is required to maintain ecosystem services under current trends in land-use change in Europe. *Landscape Ecology* 30(3): 517–534.
- Mantau, U. 2015. Wood flow analysis: Quantification of resource potentials, cascades and carbon effects. *Biomass and Bioenergy* 79. The 22nd European Biomass Conference and Exhibition held in Hamburg, June 2014: 28–38.
- Mantau, U., U. Saal, K. Prins, F. Steierer, M. Lindner, H. Verkerk, J. Eggers, N. Leek, J. Oldenburger, and A. Asikainen. 2010. Real potential for changes in growth and use of EU forests. *EUwood. Final Report*.
- Moore, B. and G. Allard. 2011. Abiotic disturbances and their influence on forest health. A review. *Forest Health and Biosecurity Working Papers (FAO)*.
- Morley, N. and D. Eatherley. 2008. *Material Security: Ensuring resource availability for the UK economy*. Chester, UK: Oakdene Hollins, Ltd. http://www.oakdenehollins.co.uk/pdf/material_security.pdf. Accessed September 17, 2013.
- MYS. 2014. *Natural Rubber Statistics 2014*. Lembaga Getah Malaysia: Malaysia Rubber Board. <http://www.lgm.gov.my/nrstat/nrstats.pdf>. Accessed March 1, 2016.
- NEDO. 2009. *Trend Report of Development in Materials for Substitution of Scarce Metals (in Japanese)*. Shinko Research Co. Ltd. (Mitsubishi UFJ Research and Consulting), NEDO (New Energy and Industrial Technology Development Organization).
- NRC. 2008. *Minerals, Critical Minerals, and the U.S. Economy*. Committee on Critical Mineral Impacts of the U.S. Economy, Committee on Earth Resources, National Research Council. Washington, D.C.: The National Academies Press.
- Nuss, P. and M.J. Eckelman. 2014. Life Cycle Assessment of Metals: A Scientific Synthesis. *PLoS ONE* 9(7): e101298.
- PEFC. 2014. Programme for the Endorsement of Forest Certification - PEFC Global Statistics: SFM & CoC Certification.
- Rosenau-Tornow, D., P. Buchholz, A. Riemann, and M. Wagner. 2009. Assessing the long-term supply risks for mineral raw materials—a combined evaluation of past and future trends. *Resources Policy* 34(4): 161–175.
- Ross, K. 2015. *Measuring sustainable forest management: A report on on-going and emerging global initiatives to develop results frameworks and performance indicators for sustainable development, agriculture and natural resources management*. Food and Agriculture Organization (FAO) of the United Nations (UN). <http://www.fao.org/forestry/42575-0ee3fc1e9d0f9619b8adfb78f836d604.pdf>. Accessed March 4, 2016.
- Sadeghi, M., P. Petrosino, A. Ladenberger, S. Albanese, M. Andersson, G. Morris, A. Lima, and B. De Vivo. 2013. Ce, La and Y concentrations in agricultural and grazing-land soils of Europe. *Journal of Geochemical Exploration* 133. Rare earth elements: The role of geology, exploration, and analytical geochemistry in ensuring diverse sources of supply and a globally sustainable resource: 202–213.
- Sikkema, R., M. Junginger, J. van Dam, G. Stegeman, D. Durrant, and A. Faaij. 2014. Legal Harvesting, Sustainable Sourcing and Cascaded Use of Wood for Bioenergy: Their Coverage through Existing Certification Frameworks for Sustainable Forest Management. *Forests* 5(9): 2163–2211.
- Silva, M.A., M. Julien, M. Jourdes, and P.-L. Teissedre. 2011. Impact of closures on wine post-bottling development: a review. *European Food Research and Technology* 233(6): 905–914.

- Sprecher, B., I. Daigo, S. Murakami, R. Kleijn, M. Vos, and G.J. Kramer. 2015. Framework for Resilience in Material Supply Chains, With a Case Study from the 2010 Rare Earth Crisis. *Environmental Science & Technology* 49(11): 6740–6750.
- UK Department for Environment, F. and R.A. (Defra). 2010. *Review of the Future Resource Risks Faced by UK Business and an Assessment of Future Viability*. London: Department for Environment, Food and Rural Affairs. <http://randd.defra.gov.uk/Default.aspx?Module=More&Location=None&ProjectID=17161>. Accessed March 1, 2016.
- UNEP. 2011. *Recycling Rates of Metals - A Status Report*. A Report of the Working Group on the Global Metal Flows to the International Resource Panel. Paris: United Nations Environment Programme (UNEP). http://www.unep.org/resourcepanel/Portals/24102/PDFs/Metals_Recycling_Rates_110412-1.pdf. Accessed July 23, 2014.
- UNEP. 2013. *Green Economy and Trade – Trends, Challenges and Opportunities*. United Nations Environment Programme (UNEP). <http://www.unep.org/greeneconomy/Portals/88/GETReport/pdf/FullReport.pdf>. Accessed March 4, 2016.
- UN-REDD. 2015. Reducing Emissions from Deforestation and Forest Degradation (REDD). <http://www.un-redd.org/aboutredd>. Accessed March 4, 2016.
- USDOE. 2010. *Critical Materials Strategy*. U.S. Department of Energy. <http://energy.gov/sites/prod/files/edg/news/documents/criticalmaterialsstrategy.pdf>. Accessed September 11, 2012.
- USDOE. 2011. *Critical Materials Strategy*. U.S. Department of Energy (USDOE). http://energy.gov/sites/prod/files/DOE_CMS2011_FINAL_Full.pdf. Accessed February 25, 2016.
- Verhoef, E.V., G.P.J. Dijkema, and M.A. Reuter. 2004. Process Knowledge, System Dynamics, and Metal Ecology. *Journal of Industrial Ecology* 8(1–2): 23–43.
- WADPA, IUCN, and UNEP-WCMC. 2015. The World Database on Protected Areas (WDPA). www.protectedplanet.net. Accessed March 4, 2016.
- WWF. 2006. *Cork screwed? Environmental and economic impacts of the cork stoppers market*. World Wildlife Fund report. <http://www.wwf.org.uk/filelibrary/pdf/corkscrewed.pdf>. Accessed April 20, 2016.
- WWF. 2015. World Wide Fund for Nature. *World Wildlife Fund*. <http://www.worldwildlife.org/>. Accessed March 2, 2016.

GETTING IN TOUCH WITH THE EU

In person

All over the European Union there are hundreds of Europe Direct information centres. You can find the address of the centre nearest you at: <http://europea.eu/contact>

On the phone or by email

Europe Direct is a service that answers your questions about the European Union. You can contact this service:

- by freephone: 00 800 6 7 8 9 10 11 (certain operators may charge for these calls),
- at the following standard number: +32 22999696, or
- by electronic mail via: <http://europa.eu/contact>

FINDING INFORMATION ABOUT THE EU

Online

Information about the European Union in all the official languages of the EU is available on the Europa website at: <http://europa.eu>

EU publications

You can download or order free and priced EU publications from EU Bookshop at: <http://bookshop.europa.eu>. Multiple copies of free publications may be obtained by contacting Europe Direct or your local information centre (see <http://europa.eu/contact>).

JRC Mission

As the science and knowledge service of the European Commission, the Joint Research Centre's mission is to support EU policies with independent evidence throughout the whole policy cycle.



EU Science Hub
ec.europa.eu/jrc



@EU_ScienceHub



EU Science Hub - Joint Research Centre



Joint Research Centre



EU Science Hub

