



🏠 [Safety Gate home \(https://ec.europa.eu/consumers/consumers_safety/safety_products/rapex/alerts/repository/content/pages/rapex/index_en.htm\)](https://ec.europa.eu/consumers/consumers_safety/safety_products/rapex/alerts/repository/content/pages/rapex/index_en.htm)

☰ [Back to report listings \(https://ec.europa.eu/consumers/consumers_safety/safety_products/rapex/alerts/?event=main.listNotifications&year=2020&lng=en\)](https://ec.europa.eu/consumers/consumers_safety/safety_products/rapex/alerts/?event=main.listNotifications&year=2020&lng=en)

🔍 [Search alerts \(https://ec.europa.eu/consumers/consumers_safety/safety_products/rapex/alerts/?event=main.search&lng=en\)](https://ec.europa.eu/consumers/consumers_safety/safety_products/rapex/alerts/?event=main.search&lng=en)

👍 [IPSW 2018 \(https://ec.europa.eu/consumers/consumers_safety/safety_products/rapex/alerts/?event=ipsw:home\)](https://ec.europa.eu/consumers/consumers_safety/safety_products/rapex/alerts/?event=ipsw:home)

The Rapid Alert System for Non-Food Products (RAPEX)

RAPEX - Weekly overview report of notifications

Week 6 - 2020

Alert A12/1410/19 has been modified on request of the notifying authority to include additional countries of destination (Austria, Croatia, Hungary, Ireland, Liechtenstein, Malta and Portugal). In agreement with the notifying authority the products in notifications A12/16438/19 and A12/1641/19 have been changed to product not of professional use. Notification A12/00021/20 has been withdrawn on request of the notifying authority after provision of corresponding test report, proving compliance with relevant EU legislation.

Alert number: A12/00144/20

Product: Ring

Name:

Risk type: Chemical

Category: Jewellery

Brand: Cindi

Type / number of model: Size 17

Type of alert: Products with serious risks

The product releases an excessive amount of nickel (measured value up to: 3 µg/cm²/week). / Nickel is a strong sensitiser and causes allergic reactions if present in articles that come into direct and prolonged contact with the skin. The product does not comply with the REACH Regulation. Withdrawal of the product from the market

Description: Golden metal ring with two engraved lines and 5 embedded rhinestones.

Batch number / Barcode:

Country of origin: People's Republic of China

Alert submitted by: Lithuania



Alert number: A12/00163/20

Product: Laser pointer

Name: HI-OUTPUT KEY CHAIN LASER / Good Luck

Risk type: Damage to sight

Category: Laser pointers

Brand: GI, GY

Type / number of model:

Type of alert: Products with serious risks

The laser beam is too powerful. Direct viewing of the laser beam could cause damage to sight. /

Recall of the product from end users, Withdrawal of the product from the market

Description: Laser pointer with keyring, powered by 3 button cells. Beside the button cells there are 11 replacement heads in the package.

Batch number / Barcode:

Country of origin: People's Republic of China

Alert submitted by: Hungary

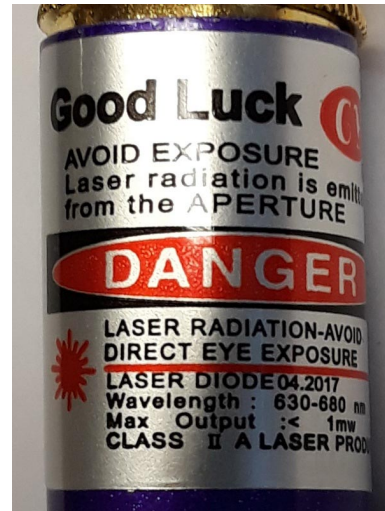

Alert number: A12/00180/20

Product: Laser pointer

Name: LASER & LED LIGHT

Risk type: Damage to sight

Category: Laser pointers

Brand:

Type / number of model: 806

Type of alert: Products with serious risks

The laser beam is too powerful. Direct viewing of the laser beam could cause damage to sight. /

Recall of the product from end users, Withdrawal of the product from the market

Description: Laser pointer with 2 LEDs torch and carabiner, powered by 3 button cells. On the product there are two buttons for switching of torch and laser. Size: 73 x 15 mm

Batch number / Barcode:

Country of origin: People's Republic of China

Alert submitted by: Hungary

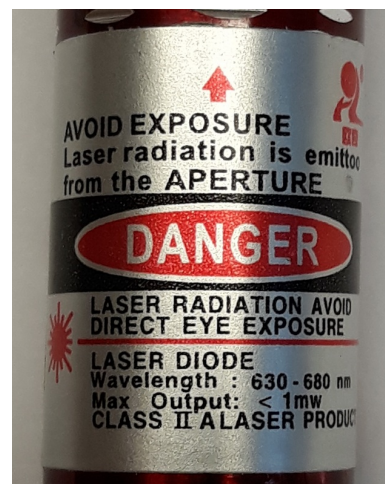

Alert number: A12/00171/20

Product: Tyre repair kit

Name: TYRE REPAIR KIT

Risk type: Chemical

Category: Chemical products

Brand: Alburnus

Type / number of model: 51376

Type of alert: Products with serious risks

The glue contains an excessive amount of toluene (measured value: 83 % by weight). Toluene is neurotoxic, if inhaled or in contact with the skin, and might also affect the unborn child. / The product does not comply with the REACH Regulation.

Withdrawal of the product from the market

Description: Tyre repair kit for cars and motorcycles, consisting of two yellow plastic tubes with chemicals, two metal tools and three pieces of sandpaper.

Batch number / Barcode: 2111005137610

Country of origin: People's Republic of China

Alert submitted by: Lithuania

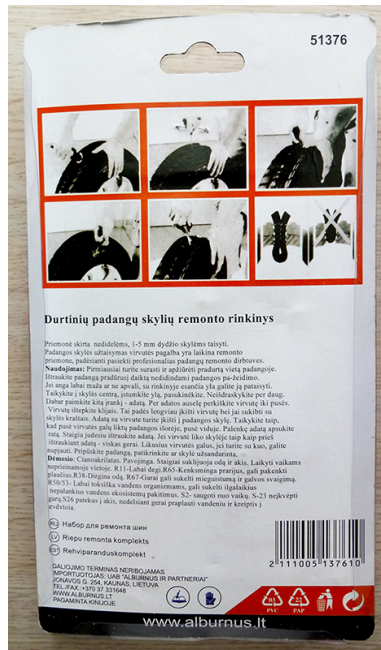

Alert number: A12/00158/20

Product: Angle Grinder

Name: RAIDER RD – AG33

Risk type: Injuries

Category: Machinery

Brand: RAIDER

Type / number of model: RD-AG33

Type of alert: Products with serious risks

The disc guard does not provide sufficient protection against flying particles in the event of a breakage of the grinding disc. As a result, uncontrolled flying parts may cause injuries to the user. / The product does not comply with the requirements of the Machinery Directive and the relevant European standard EN 60745.

Withdrawal of the product from the market

Description: Electric powered angle grinder.

Batch number / Barcode: 800123162459

Country of origin: People's Republic of China

Alert submitted by: Slovenia



Alert number: A12/00159/20

Product: Angle Grinder

Name: SPILEC S1M – KZ22 – 115W

Risk type: Injuries

Category: Machinery

Brand: SPILEC

Type / number of model: S1M-KZ2-115W

Type of alert: Products with serious risks

The disc guard does not provide sufficient protection against flying particles in the event of a breakage of the grinding disc. As a result, uncontrolled flying parts may cause injuries to the user. / The product does not comply with the requirements of the Machinery Directive and the relevant European standard EN 60745.

Recall of the product from end users

Company recall page: <https://www.e-leclerc.si/novice/27730> (<https://www.e-leclerc.si/novice/27730>)

Description: Electric powered Angle grinder.

Batch number / Barcode: 601010073946

Country of origin: People's Republic of China

Alert submitted by: Slovenia



Alert number: A12/00140/20

Product: Passenger car

Name: Tiguan, Touran

Risk type: Fire, Injuries

Category: Motor vehicles

Brand: VW

Type / number of model: Type approval number: e1*2001/116*0450*; e1*2001/116*0211*, Type: 5N, 1T

Type of alert: Products with serious risks

The fuel tank wall is not sufficiently thick. / Consequently, in the event of an accident it could break and leak fuel increasing the risk of fire or explosion.

Recall of the product from end users

Description: Passenger car.

Batch number / Barcode: 20BV

Country of origin: Germany

Alert submitted by: Germany

Alert number: A12/00142/20

Product: Passenger van/ Light commercial vehicle

Name: eVito

Risk type: Fire, Injuries

Category: Motor vehicles

Brand: Mercedes- Benz

Type / number of model: Type approval number: e1*2007/46*0457*20 - *21, e1*2007/46*0458*14 - *16, Type: 639/2, 639/4

Type of alert: Products with serious risks

The bolt connecting the electric motor housing and the power electronics might be defective. / Consequently, it might trigger a short circuit, which could cause the engine to fail, increasing the risk of accident or even lead to a fire.

Recall of the product from end users

Description: Passenger van/ Light commercial vehicle.

Batch number / Barcode: V2EMOLEI (0490151)

Country of origin: Germany

Alert submitted by: Germany

Alert number: A12/00148/20

Product: Passenger car

Name: Alhambra

Risk type: Injuries

Category: Motor vehicles

Brand: Seat

Type / number of model: Model year: 2015 (710*), 2016 (711*), e1*2007/46*0402*09, e1*2007/46*0402*11, e1*2007/46*0402*12

Type of alert: Products with serious risks

A condenser of the airbag control unit might have an insufficient thermal treatment. / Consequently, the condenser might fail which could lead the airbag control unit to detect a non occurring frontal collision and trigger the airbags and seatbelt tensioners, increasing the risk of an accident.

Recall of the product from end users

Description: Passenger car under Seat recall code 69Z6.

Batch number / Barcode: 69Z6

Country of origin: Portugal

Alert submitted by: Portugal

Alert number: A12/00149/20

Product: Motorcycle

Name: Speed Twin

Risk type: Injuries

Category: Motor vehicles

Brand: Triumph Motorcycles

Type / number of model: e5*168/2013*00013

Type of alert: Products with serious risks

The gear change lever linkage may become loose from the ball joint. / Consequently, the end of the gear lever might excessively move, preventing the driver from changing gear, increasing the risk of an accident.

Recall of the product from end users

Description: Motorcycle

Batch number / Barcode: SRAN569

Country of origin: United Kingdom

Alert submitted by: United Kingdom

Products were found and measures were taken also in: Poland

Alert number: A12/00150/20

Product: Motorcycle

Name: Thruxton, Thruxton R, Thruxton TFC, Thruxton 1200, Thruxton 1200R

Risk type: Injuries

Category: Motor vehicles

Brand: Triumph Motorcycles

Type / number of model: e9*168/2013*11258*01

Type of alert: Products with serious risks

The side stand spring may fracture. / As a result, with the side stand folded up, the side stand cut-off switch might be engaged, leading the engine to stall, increasing the risk of accident.

Recall of the product from end users

Description: Motorcycle.

Batch number / Barcode: SRAN570

Country of origin: United Kingdom

Alert submitted by: United Kingdom

Products were found and measures were taken also in: Poland

Alert number: A12/00152/20

Product: Passenger car

Name: Panda

Risk type: Injuries

Category: Motor vehicles

Brand: Fiat

Type / number of model: Type-approval number: e3*2007/46*0064*52, Type: 312

Type of alert: Products with serious risks

The Fiat logo on the steering wheel cover is not sufficiently attached. As a result, in the event of an accident resulting in the release of the airbag, the logo can be projected at high speed, causing injuries to the occupants. /

Recall of the product from end users

Description: Passenger car under Fiat recall code: 6266.

Batch number / Barcode: 6266

Country of origin: Italy

Alert submitted by: Germany

Products were found and measures were taken also in: Poland

Alert number: A12/00153/20

Product: Pickup truck

Name: Amarok

Risk type: Injuries

Category: Motor vehicles

Brand: VW

Type / number of model: Type-approval number: e1*2007/46*0356* , Type: 2H

Type of alert: Products with serious risks

The glue that holds the glass side-windows on the hardtop has insufficient adhesion due to a manufacturing error. As a result, the windows may become detached from the vehicle, posing a risk to the following traffic. /

Recall of the product from end users

Description: Pickup trucks outfitted with a hardtop under VW recall code: 61B9.

Batch number / Barcode: 61B9

Country of origin: Germany

Alert submitted by: Germany

Alert number: A12/00154/20

Product: Passenger car

Name: Sorento

Risk type: Injuries

Category: Motor vehicles

Brand: KIA

Type / number of model: Type-approval numbers: e4*2007/46*0894*10, e4*2007/46*0894*08

Type of alert: Products with serious risks

Due to an error in the Frontal Collision-Avoidance Assist (FCA) software, the braking assist function may fail when the vehicle approaches a stationary vehicle or a pedestrian. Consequently, the braking assist may not activate during a frontal collision, increasing the risk of injury to vehicle occupants and other road users. /

Recall of the product from end users

Description: Passenger car.

Batch number / Barcode:

Country of origin: Republic of Korea

Alert submitted by: Poland

Products were found and measures were taken also in: Estonia

Alert number: A12/00155/20

Product: Passenger van / Light commercial vehicle

Name: Master

Risk type: Injuries

Category: Motor vehicles

Brand: Renault

Type / number of model: Type-approval numbers: e2*2007/46*0016*34, e2*2007/46*0016*35, e2*2007/46*0016/36, e2*2007/46*0016*37, e2*2007/46*0047*28, e2*2007/46*0047*29, e2*2007/46*0047*30, e2*2007/46*0047*31

Type of alert: Products with serious risks

Passenger airbag fixing screws can be insufficiently tightened or missing. This can impair the airbag's protective function, increasing the risk of injury in the event of an accident. /

Recall of the product from end users

Description: Vehicles manufactured at the Batilly plant equipped with a passenger airbag.

Batch number / Barcode:

Country of origin: France

Alert submitted by: France

Alert number: A12/00156/20

Product: Passenger car

Name: Suberb

Risk type: Injuries

Category: Motor vehicles

Brand: Skoda

Type / number of model: Type-approval numbers: e11*2001/116*0326*00-45, e8*2007/46*0317*00-07, Type: 3T

Type of alert: Products with serious risks

Possible defect in the airbag control unit (ACU). This can impair the proper functioning of the airbags and seatbelt tensioners, increasing the risk of injury in the event of an accident. /

Recall of the product from end users

Description: Passenger car under Skoda recall code: 69Z9.

Batch number / Barcode: 69Z9

Country of origin: Czechia

Alert submitted by: Germany

Products were found and measures were taken also in: Ireland

Alert number: A12/00157/20

Product: Passenger car

Name: Vivaro, Zafira Life

Risk type: Injuries

Category: Motor vehicles

Brand: Opel

Type / number of model: Type-approval numbers: e2*2007/46*0533*08, e2*2007/46*0532*10, Type: V

Type of alert: Products with serious risks

The bolting of the rear axle can be defective. This may lead to a loss of driving stability, increasing the risk of an accident. /

Recall of the product from end users

Description: Passenger car under Opel recall code: E19-191187 - E19-190482.

Batch number / Barcode: E19-191187 - E19-190482

Country of origin: France

Alert submitted by: Germany

Alert number: A12/00160/20

Product: Passenger car

Name: Celica, RAV4, Starlet and Yaris

Risk type: Injuries

Category: Motor vehicles

Brand: Toyota

Type / number of model: - Model Year: 1997~1999., Celica: 199410002462 0006; Model code: AT200, ST202, ST204, RAV4: 199510002904 0019; Model code: SXA10, SXA11, SXA15, SXA16, Starlet: 199610000485 0010; Model code: EP91, Yaris: 199910000254 0001; Model code: SCP10

Type of alert: Products with serious risks

The ammonium nitrate propellant used in the airbag inflator may experience a material alteration over time due to degradation occurring after prolonged exposure to high absolute humidity, high temperatures and high-temperature cycling. / In the event of an airbag being deployed, it may deploy too slowly or the excessive internal pressure may cause the inflator body to rupture and metal fragments may pass through the cushion material causing injury to the occupants.

Recall of the product from end users

Description: Passenger car equipped with Takata airbags.

Batch number / Barcode: 20SMD-005

Country of origin: Japan

Alert submitted by: Portugal

Products were found and measures were taken also in: Estonia, Poland

Alert number: A12/00165/20

Product: Lorry

Name: Actros, Arocs, Atego

Risk type: Injuries

Category: Motor vehicles

Brand: Mercedes- Benz

Type / number of model: Models: 963-0-A, 963-4-A, 963-2-A, 963-0-B, 963-4-B, 963-2-B, 963-2-B, 963-4-C, 963-0-D, 963-4-D , 963-7-E, 963-4-E, 963-2-E, 963-4-F, 963-2-F, 963-8-G, 963-8-H, 967PKX2, 967PKX3, 967FWU2, 967FWU3, Type-approval numbers: e1*2007/46*0726, *0727, *0728, *0729, *0730, *0731, *0732, *0733, *0734, *0735, *0736, *0737, *0738, *0740, *0741, *0742, *0743, *1170, *1171, *1175, *1176

Type of alert: Products with serious risks

One or more screw connections on the steering bracket that fixes the steering gearbox to the frame head or the front frame reinforcement may not have been correctly tightened. If they become loose, this would increase the steering play and impair the steering control. /

Recall of the product from end users

Description: Lorry

Batch number / Barcode: BEF-LENK

Country of origin: Germany

Alert submitted by: Germany

Alert number: A12/00167/20

Product: Motorcycle

Name: Vespa GTS 125-300, Vespa GTV300

Risk type: Injuries

Category: Motor vehicles

Brand: Piaggio

Type / number of model: Model 2019

Type of alert: Products with serious risks

The brake line terminals might have been incorrectly galvanised. / Consequently, hydrogen could leak into the brake fluid, causing an extended brake lever travel, decreasing the braking capacity and increasing the risk of accident.

Recall of the product from end users

Description: Motorcycle.

Batch number / Barcode: PP2ZZQ1904_GTS

Country of origin: Italy

Alert submitted by: Italy

Products were found and measures were taken also in: Poland

Alert number: A12/00177/20

Product: Lorry

Name: TGM

Risk type: Injuries

Category: Motor vehicles

Brand: MAN

Type / number of model: Models: L.2007.46.009, L.2007.46.013, Type-approval number: e4*2007/46*0237*33 - 36, e4*2007/46*0418*31

Type of alert: Products with serious risks

The safety locking ring on the rims is incorrectly fitted and may suddenly become detached. As a result, the tyre will suddenly deflate, impairing the control over the vehicle and increasing the risk of an accident. /

Recall of the product from end users

Description: Lorry

Batch number / Barcode: TI 7030TR

Country of origin: Austria

Alert submitted by: Germany

Alert number: A12/00178/20

Product: Passenger car / Light commercial vehicle

Name: Kangoo

Risk type: Injuries

Category: Motor vehicles

Brand: Renault

Type / number of model: Type-approval numbers: e2*2001/116*0364*48, e2*2007/46*0006*43, e2*2007/46*0089*13

Type of alert: Products with serious risks

The components on the rear axle may not be sufficiently clamped. As a result, the rear wheels may become locked or disengaged, increasing the risk of an accident. /

Recall of the product from end users

Description: Passenger car / Light commercial vehicles manufactured in Maubeuge under Renault recall code: 0D8L.

Batch number / Barcode: 0D8L

Country of origin: France

Alert submitted by: Portugal

Alert number: A12/00161/20

Product: Children's travel seat

Name: Pack -it! Seat Me Safe Travel Seat

Risk type: Strangulation

Category: Childcare articles and children's equipment

Brand: Koo-Di

Type / number of model: KD066/02

Type of alert: Products with serious risks

The product contains cords designed to be used as ties that are too long and can create a loop. They might pass over a child's head and lead to strangulation. /

Recall of the product from end users

Company recall page: <https://koo-di.com/pages/product-recall-notice> (<https://koo-di.com/pages/product-recall-notice>)

Description: The product is a travel seat designed to be scrunched into an integrated small pouch to assist with child restraint at the dining room table "when eating out and travelling" for a 6-30 month old child. The colour is grey and green.

Batch number / Barcode: 5060023802765

Country of origin: People's Republic of China

Alert submitted by: United Kingdom

Products were found and measures were taken also in: Estonia



Alert number: A12/00141/20

Product: Toy slime

Name:

Risk type: Chemical

Category: Toys

Brand: Zeeman

Type / number of model: C50092 A64057 071900

Type of alert: Products with serious risks

The migration of boron from the toy slime is too high (measured value: 3520 mg/kg). / Ingestion or contact with an excessive quantity of boron may harm the health of children by damaging their reproductive system. The product does not comply with the requirements of the Toy Safety Directive and the relevant European standard EN 71-3.

Recall of the product from end users

Description: Toy slime consisting of green, blue and yellow small balls embedded in an sticky slime.

Batch number / Barcode: 2099902640573

Country of origin: People's Republic of China

Alert submitted by: Belgium



Alert number: A12/00145/20

Product: Plastic doll

Name: Lalka

Risk type: Chemical

Category: Toys

Brand:

Type / number of model: LOT N°: R180801

Type of alert: Products with serious risks

The plastic material of the product contains an excessive amount of di-'isononyl' phthalate (DINP)(measured value: 1.1 % by weight). / This phthalate may harm the health of children, causing possible damage to their reproductive system and liver. The product does not comply with the REACH Regulation.

Withdrawal of the product from the market

Description: Plastic doll with brown hair in a pink and yellow dress.

Batch number / Barcode: 5901271488731

Country of origin: People's Republic of China

Alert submitted by: Latvia



Alert number: A12/00146/20

Product: Bath book

Name: Wieloryb Wielgus

Risk type: Chemical

Category: Toys

Brand: Zielona Sowa

Type / number of model: ISBN 978-83-8073-246-9

Type of alert: Products with serious risks

The plastic material of the pages contains an excessive amount of tris(2-chloroethyl) phosphate (TCEP)(measured value: 7.5 mg/kg). / TCEP may impair fertility by damaging the reproductive system and might cause cancer. The product does not comply with the requirements of the Toy Safety Directive and the relevant European standard EN 71-9.

Destruction of the product, Warning consumers of the risks, Withdrawal of the product from the market

Company recall page: <http://www.zielonasowa.pl/> (<http://www.zielonasowa.pl/>)

Description: Waterproof children's activity book made of plastic.

Batch number / Barcode: 9788380732469

Country of origin: People's Republic of China

Alert submitted by: Poland

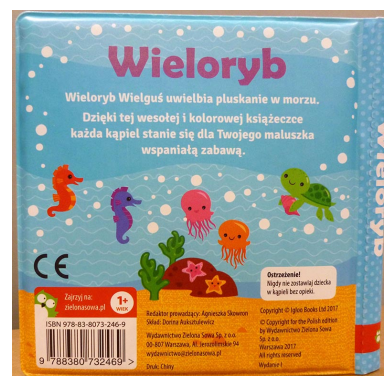
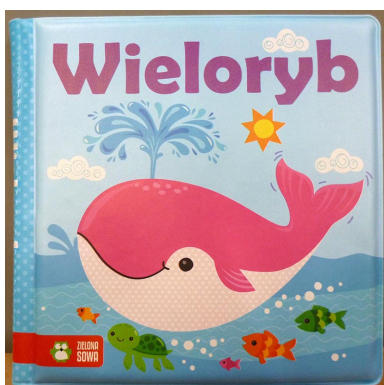

Alert number: A12/00151/20

Product: Plastic doll set

Name: Girl Fashion

Risk type: Chemical

Category: Toys

Brand: Girl Fashion

Type / number of model: NO. DSJ796; PANPAN 8W2-199 (on the label)

Type of alert: Products with serious risks

The plastic material of the doll's head contains an excessive amount of bis(2-ethylhexyl) phthalate (DEHP) (measured value: 31 % by weight). This phthalate may harm the health of children, causing possible damage to the reproductive system. / The product does not comply with the REACH Regulation.

Recall of the product from end users, Withdrawal of the product from the market

Description: A plastic doll with clothes, boots, bag and phone accessories.

Batch number / Barcode: 6998880084484

Country of origin: People's Republic of China

Alert submitted by: Hungary



Alert number: A12/00164/20

Product: Toy slime

Name: Unicorn Poop

Risk type: Chemical

Category: Toys

Brand: Super Cool

Type / number of model: ECXL-18

Type of alert: Products with serious risks

The migration of boron from the toy slime is too high (measured value up to 2930 mg/kg). Ingestion or contact with an excessive quantity of boron may harm the health of children by damaging their reproductive system. / The product does not comply with the requirements of the Toy Safety Directive and the relevant European standard EN 71-3.

Warning consumers of the risks

Description: Multicoloured (yellow, pink, green) liquid/jelly slime.

Batch number / Barcode: 6989215784056

Country of origin: People's Republic of China

Alert submitted by: Estonia



Alert number: A12/00166/20

Product: Doctor set

Name: Guardian Health Doctor

Risk type: Chemical

Category: Toys

Brand: Shun Xing

Type / number of model: Article no. 5988

Type of alert: Products with serious risks

The quantity of phthalates exceed the maximum permitted level on toys, 0,1 %. Phthalates may harm the health of children, causing possible damage to the reproductive system. / EC Regulation 1907/2006 (REACH), Directive 2009/98/EC of the European Parliament and the Council on the safety of toys

Import rejected at border

Description: Toy set includes a pink doctors briefcase with different plastic items such as eyeglasses, syringe, spoon, scissors, name tag, weight, thermometer, knife, examination plate, tweezers and stethoscope.

Batch number / Barcode: 6438159059886

Country of origin: People's Republic of China

Alert submitted by: Finland



Alert number: A12/00172/20

Product: Plastic bouncing ball

Name: Pilka do skakania

Risk type: Chemical

Category: Toys

Brand:

Type / number of model: 8732

Type of alert: Products with serious risks

The plastic material of the product contains an excessive amount of diisobutyl phthalate (DIBP)(measured value: 28 % by weight). This phthalate may harm the health of children by causing possible damage to their reproductive system. / The product does not comply with the REACH Regulation and the requirements of the Toy Safety Directive.

Withdrawal of the product from the market

Description: Pink plastic Inflatable bouncing ball with two handles.

Batch number / Barcode: 5960037970200

Country of origin: People's Republic of China

Alert submitted by: Poland



Alert number: A12/00179/20

Product: Baby teether

Name: ez grip massaging teether

Risk type: Choking

Category: Toys

Brand: innobaby

Type / number of model: TE-303 BERRY

Type of alert: Products with serious risks

The leaves and stem of the product can easily break, generating small parts. A small child may put them in the mouth and choke. / The product does comply with Toy Safety Directive and the relevant European standards EN 71-1 and EN 1400.

Recall of the product from end users Ban on the marketing of the product and any accompanying measures

Company recall page: <https://www.vaukirja.fi/tarkea-tiedote-tuotteesta/> (available in Finnish and in Swedish) (<https://www.vaukirja.fi/tarkea-tiedote-tuotteesta/> (available in Finnish and in Swedish))

Description: Silicon teether in the shape of a strawberry. The product was also sold online.

Batch number / Barcode: 850587003853

Country of origin: United States

Alert submitted by: Finland



Alert number: A12/00182/20

Product: Squeezable toy

Name: Squishy

Risk type: Choking

Category: Toys

Brand: Zabawka Squishy

Type / number of model: N° 31951

Type of alert: Products with serious risks

When using the squishy, small parts may become detached. A small child may put them in the mouth and choke. / The product does not comply with the requirements of the Toy Safety Directive and the relevant European standard EN 71-1.

Stop of sales Ban on the marketing of the product and any accompanying measures

Description: Plastic toy (squishy) in the form of a unicorn. After squeezing, it slowly returns to its original form.

Batch number / Barcode: 9981686319512

Country of origin: Unknown

Alert submitted by: Germany



Alert number: A12/00169/20

Product: Children's sports trousers

Name:

Risk type: Injuries

Category: Clothing, textiles and fashion items

Brand: „C&Q kids“

Type / number of model:

Type of alert: Products with serious risks

The product bears long cords with free ends at the waist area. These cords may become trapped during various activities of a child, leading to injuries. / The product does not comply with the relevant European standard EN 14682.

Withdrawal of the product from the market

Description: Children's sports trousers with cords in the waist area, intended for small children.

Batch number / Barcode:

Country of origin: Turkey

Alert submitted by: Bulgaria

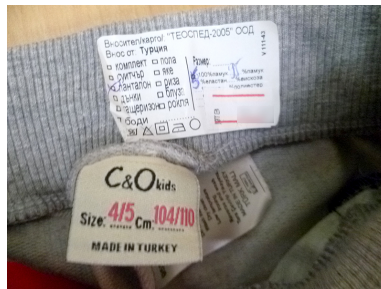

Alert number: A12/00170/20

Product: Children's sports dress

Name:

Risk type: Choking, Injuries

Category: Clothing, textiles and fashion items

Brand: Wanex

Type / number of model:

Type of alert: Products with serious risks

The product bears long cords with free ends at the waist area. These cords may become trapped during various activities of a child, leading to injuries. Additionally, the product has small parts (rhinestones) that can be easily detached. A small child may put them in the mouth and choke on them. / The product does not comply with the relevant European standard EN 14682.

Withdrawal of the product from the market

Description: Children's sports dress with glued rhinestones and cords in the waist area, intended for small children up to 3 years of age.

Batch number / Barcode: 8001234620943

Country of origin: Turkey

Alert submitted by: Bulgaria



Alert number: A12/00176/20

Product: Baby's bodysuit

Name:

Risk type: Strangulation

Category: Clothing, textiles and fashion items

Brand: Nipper land

Type / number of model: code 6523

Type of alert: Products with serious risks

The product has long drawstrings with free ends in the neck area. These drawstrings can become trapped during various activities of a child, leading to strangulation. / The product does not meet the requirements of European standard EN 14682

Withdrawal of the product from the market

Description:

https://webgate.acceptance.ec.europa.eu/consumers/consumers_safety/safety_products/rapex/alerts/repository/content/pages/rapex/index_en.htm

Batch number / Barcode:

Country of origin: Turkey

Alert submitted by: Bulgaria



Alert number: A12/00181/20

Product: Baby body lotion

Name: Baby Pflegelotion

Risk type: Microbiological

Category: Cosmetics

Brand: dm alverde

Type / number of model: Bio-Sheabutter Bio-Kamille

Type of alert: Products with serious risks

The product contains an excessive amount of mesophilic aerobic yeast (measured value at least: 260 cfu/g), among which *Wickerhamomyces anomalus*. This yeast might be an opportunistic pathogen, which could lead to infection, if the product is used by immune-compromised persons or applied on damaged skin or mucous membranes. / The product does not comply with the Cosmetic Products Regulation.

Recall of the product from end users, Withdrawal of the product from the market

Company recall page: <https://www.dm.de/unternehmen/medien-und-presse/pressemitteilungen/dm-marken/verbraucherinformation-alverde-baby-pflegelotion-c1425456.html> (<https://www.dm.de/unternehmen/medien-und-presse/pressemitteilungen/dm-marken/verbraucherinformation-alverde-baby-pflegelotion-c1425456.html>)

Description: 200 ml of white cream for small children. The product was also sold online.

Batch number / Barcode: 4 010355219015

Country of origin: Germany

Alert submitted by: Germany

Products were found and measures were taken also in: Austria



Alert number: A12/00143/20

Product: Mains extension lead

Name: 2POWER SOCKET 4USB

Risk type: Electric shock

Category: Electrical appliances and equipment

Brand: Glisteny

Type / number of model: SFC08-2

Type of alert: Products with serious risks

The product lacks protective conductor contacts in the built in sockets. / Consequently, the user could receive an electric shock. The product does not comply with the requirements of the Low Voltage Directive and the relevant national standard.

Removal of this product listing by the online marketplace

Description: Multiple socket plug with two sockets and 4 USB ports. The product can be used directly plugged to the mains socket or as an extension lead thanks to the detachable plug and 1.5 m cable. It is packed in a white cardboard box. The product was also sold online, in particular via Amazon.

Batch number / Barcode:

Country of origin: People's Republic of China

Alert submitted by: Germany



Product model	SFC08-2
Rated current	10A
Rated voltage	250V
Rated power	1200W
USB output	5V ~ 2.4A(Support 2A fast charge) 12W
Output port	2 x Sockets Combo 4xUSB
Product size	185x55x39mm
Power cord	1.5M

Alert number: A12/00147/20

Product: Travel adaptor

Name: Travel adaptor / World Travel Adapter

Risk type: Electric shock

Category: Electrical appliances and equipment

Brand: ORNO

Type / number of model: OR-AE-1399

Type of alert: Products with serious risks

While plugged into a socket, the unused live pins of the product are accessible. / The user could touch the accessible live pins and receive an electric shock. The product does not comply with the relevant standard EN-60884.

Withdrawal of the product from the market

Description: Travel adaptor suitable for sockets in Europe, Australia, China, Japan and the USA.

Batch number / Barcode: 5902560324877

Country of origin: People's Republic of China

Alert submitted by: Poland



Alert number: A12/00162/20

Product: USB Charger

Name: Travel Charger

Risk type: Electric shock

Category: Electrical appliances and equipment

Brand:

Type / number of model: HR-SC001

Type of alert: Products with serious risks

The suppression capacitor between the mains primary and USB secondary circuits is not strong enough. Consequently, the accessible USB port becomes live increasing the risk of electric shock. / The product does not comply with the Low Voltage Directive and the relevant European standard EN 62368-1.

Withdrawal of the product from the market

Company recall page: <http://partnertele.com/productrecall/> (<http://partnertele.com/productrecall/>)

Description: USB charger

Batch number / Barcode: 5901737991959

Country of origin: People's Republic of China

Alert submitted by: Poland



Alert number: A12/00173/20

Product: Laptop power supply

Name:

Risk type: Electric shock

Category: Electrical appliances and equipment

Brand: Connect XL

Type / number of model: CXL-PN90C

Type of alert: Products with serious risks

The product's electric insulation, electric strength and clearance/creepage distances are insufficient. Consequently, the user could touch accessible live parts, increasing the risk of receiving an electric shock. / The product does not comply with the requirements of the Low Voltage Directive and the relevant European standard EN 60950-1.

Recall of the product from end users, Withdrawal of the product from the market

Description: Universal power supply for notebooks/laptops with 8 different exchangeable output connectors.

Batch number / Barcode: 3856001015522

Country of origin: People's Republic of China

Alert submitted by: Croatia



Alert number: A12/00174/20

Product: USB Charger

Name: 2-PORT HOME CHARGER+

Risk type: Electric shock

Category: Electrical appliances and equipment

Brand: belkin

Type / number of model: F8J052

Type of alert: Products with serious risks

The product's electrical insulation, clearance/creepage distances between its primary and secondary circuits and safety capacitor are inappropriate. Consequently, live parts might become accessible or the accessible USB ports might become live, increasing the risk of the user receiving an electric shock. / The product does not comply with the requirements of the Low Voltage Directive and the relevant European standard EN 60950-1.

Warning consumers of the risks

Company recall page:

<https://flavour-design.pl/ladowarka-belkin-f8j052> (<https://flavour-design.pl/ladowarka-belkin-f8j052>)

[b341.html](https://ec.europa.eu/consumers/consumers_safety/safety_products/rapex/alerts/b341.html) (https://ec.europa.eu/consumers/consumers_safety/safety_products/rapex/alerts/b341.html)

Description: External power supply to be plugged to the mains with USB ports capable of delivering 2.1 A.

Batch number / Barcode: 745883636501

Country of origin: People's Republic of China

Alert submitted by: Poland



Alert number: A12/00175/20

Product: Laptop power supply

Name: Universal notebook AC adapter

Risk type: Electric shock

Category: Electrical appliances and equipment

Brand: Yankee

Type / number of model: YAU 90111

Type of alert: Products with serious risks

The product's electric insulation and clearance/creepage distances are insufficient. Consequently, the user could touch accessible live parts, increasing the risk of receiving an electric shock. / The product does not comply with the requirements of the Low Voltage Directive and the relevant European standard EN 60950-1.

Recall of the product from end users, Withdrawal of the product from the market

Description: Universal power supply for notebooks/laptops delivering up to 90 W output and with 11 different exchangeable output connectors.

Batch number / Barcode: 8590669261529

Country of origin: People's Republic of China

Alert submitted by: Croatia



Alert number: INFO/00030/20

Product: Laser pointer

Name:

Risk type: Damage to sight

Category: Laser pointers

Brand:

Type / number of model:

Type of alert: Products with other risk levels

The product lacks clear warning texts on the possible risks associated with the use of the product. Consequently, a user could misuse the product and directly watch the laser beam or its mirror reflection, causing damage to the sight. / The product does not comply with the relevant European standard EN 60825-1

Withdrawal of the product from the market

Description: Laser pointer.

Batch number / Barcode:

Country of origin: Unknown

Alert submitted by: Bulgaria



Alert number: A11/00016/20

Product: Lighting chain

Name:

Risk type: Electric shock

Category: Lighting chains

Brand: DRF

Type / number of model: 56486 (on the packaging)

Type of alert: Products with other risk levels

The insulation between live parts and the accessible metal screw of the motor shaft is insufficient. Additionally, the power cord is not strongly attached to the product. Consequently, accessible parts might become live, increasing the risk of the user receiving an electric shock. / The product does not comply with the requirements of the Low Voltage Directive and the relevant European standard EN 60598.

Import rejected at border

Description: Closed LED lighting chain attached to reindeer-shaped frame. The reindeer's can move its head.

Batch number / Barcode:

Country of origin: People's Republic of China

Alert submitted by: Hungary



Alert number: A11/00017/20

Product: Lighting chain

Name: MERRY CHRISTMAS 3M x 3M/LED

Risk type: Choking, Electric shock

Category: Lighting chains

Brand:

Type / number of model: M300/300

Type of alert: Products with other risk levels

The cable is too thin. The cable could overheat leading to a fire. The accessible wires have only basic insulation. The cable could become damaged leaving the live conductors accessible. As a consequence, the user could receive an electric shock from accessible live parts. / The product does not comply with the requirements of the Low Voltage Directive and the relevant European standard EN 60598.

Import rejected at border

Description: Curtain-shaped decorative lighting chain with non-replaceable white LEDs. The product allows the connection of another lighting chain. The socket at the end of the power cord is sealed with an end cap.

Batch number / Barcode: 5 799104 579073

Country of origin: People's Republic of China

Alert submitted by: Hungary



Alert number: A11/00018/20

Product: Lighting chain

Name: MERRY CHRISTMAS 5M LED

Risk type: Choking, Electric shock

Category: Lighting chains

Brand:

Type / number of model: M 500

Type of alert: Products with other risk levels

The accessible wires have insufficient insulation and the cable is too thin. As a consequence, the cable could get damaged, leaving the live conductors accessible and the user could receive an electric shock. The cable could also overheat, leading to a fire risk. / The product does not comply with the requirements of the Low Voltage Directive and the relevant European standard EN 60598.

Import rejected at border

Description: Icicle-shaped decorative lighting chain with non-replaceable LEDs. The product allows the connection of another lighting chain. The socket at the end of the power cord is sealed with an end cap.

Batch number / Barcode: 5 799104 579011

Country of origin: People's Republic of China

Alert submitted by: Hungary



Alert number: A11/00012/20

Product: Children's bicycle seat

Name: Child Seat for Two

Risk type: Injuries

Category: Childcare articles and children's equipment

Brand: Butchers & Bicycles

Type / number of model: Item NO. 0360

Type of alert: Products with other risk levels

The child seat can break in the mounting zone in the event of an emergency braking or collision. This may cause the seat to partially or fully detach from the cargo box, increasing the risk of injuries. /

Temporary ban on the supply, offer to supply and display of the product

Company recall page: <https://butchersandbicycles.odoo.com/recall> (<https://butchersandbicycles.odoo.com/recall>)

Description: Child Seat for Two, for a cargo bike MK1-E.

Batch number / Barcode:

Country of origin: People's Republic of China

Alert submitted by: Denmark

Products were found and measures were taken also in: Finland, Ireland

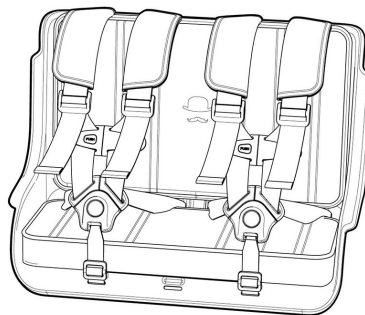

Alert number: INFO/00028/20

Product: Baby pushchair

Name: LECAPRICE

Risk type: Injuries

Category: Childcare articles and children's equipment

Brand: 4BABY

Type / number of model:

Type of alert: Products with other risk levels

The pushchair is not stable enough and may tip over. A child may consequently suffer injuries. / The product does not comply with the relevant European standard EN 1888.

Making the marketing of the product subject to prior conditions

Description: Baby pushchair

Batch number / Barcode: 5901691953420

Country of origin: People's Republic of China

Alert submitted by: Poland

Products were found and measures were taken also in: Estonia



Alert number: A11/00011/20

Product: Soft toy

Name: plüss figura / Plush toy

Risk type: Choking

Category: Toys

Brand:

Type / number of model: Item NO. 62171

Type of alert: Products with other risk levels

The fibrous stuffing material of the toy is easily accessible due to the weakness of certain seams. A small child may put the stuffing material in the mouth and choke. / The product does not comply with the requirements of the Toy Safety Directive and with the relevant European standards EN 71-1.

Withdrawal of the product from the market

Description: Plush watermelon with brown plastic eyes and brown textile legs and hands.

Batch number / Barcode: 8588588621715

Country of origin: People's Republic of China

Alert submitted by: Hungary



Alert number: A11/00013/20

Product: Battery-operated toy

Name:

Risk type: Chemical

Category: Toys

Brand:

Type / number of model: N° BKZXD-007

Type of alert: Products with other risk levels

The batteries compartment can easily be opened without the use of any tools, leaving batteries accessible. A child may take a (damaged or leaking) battery and suffer from injuries due to the leaking chemical products. / The product does not comply with the requirements of the Toy Safety Directive and the relevant European standard EN 62115.

Destruction of the product

Description: Plastic toy in the shape of a white crown with lights, operated with 2 AA batteries (not included).

Batch number / Barcode: 6950181080077

Country of origin: People's Republic of China

Alert submitted by: Latvia



Alert number: A11/00014/20

Product: Soft toy

Name: Electric dog

Risk type: Chemical

Category: Toys

Brand:

Type / number of model: 294555, N°. R713

Type of alert: Products with other risk levels

The battery compartment can easily be opened without the use of any tools, leaving batteries accessible. / A child may take a damaged or leaking battery and suffer burns due to the leaking chemical products. The product does not comply with the requirements of the Toy Safety Directive and the relevant European Standard EN 62115.

Destruction of the product

Description: Battery operated soft toy in the shape of a dog with light brown fur and wearing a hat, glasses and pipe. The product was also sold online.

Batch number / Barcode: 4983726169083

Country of origin: People's Republic of China

Alert submitted by: Latvia



Alert number: A11/00015/20

Product: Soft toy

Name: Electric dog

Risk type: Chemical

Category: Toys

Brand:

Type / number of model: 294556, N°. R716

Type of alert: Products with other risk levels

The battery compartment can easily be opened without the use of any tools, leaving batteries accessible. / A child may take a damaged or leaking battery and suffer burns due to the leaking chemical products. The product does not comply with the requirements of the Toy Safety Directive and the relevant European Standard EN 62115.

Destruction of the product

Description: Battery operated soft toy in the shape of a dog with white-black fur wearing a red ribbon with dots around the neck and flower on the head. The product was also sold online.

Batch number / Barcode: 4983726169090

Country of origin: People's Republic of China

Alert submitted by: Latvia



Alert number: INFO/00027/20

Product: Slingshot

Name:

Risk type: Injuries

Category: Toys

Brand:

Type / number of model:

Type of alert: Products with other risk levels

According to its properties the product is a catapult. Consequently, it cannot be sold as a toy due to its potential risk for children. / The product does not comply with requirements of the Toy safety Directive.

Removal of this product listing by the online marketplace

Description: Hand slingshot made of aluminium with several rubber bands. The product was sold online, in particular via Aliexpress.

Batch number / Barcode:

Country of origin: Unknown

Alert submitted by: Denmark

